



E-TENDER

FOR

Name of work: Reconstruction of compound wall along Trunk Main on R. N. Gandhi Marg in N ward.

-sd-

S.E.W.W. (Civil) Maint

-sd-

S.E.W.W. (Civil) Maint

-sd-

A.E.W.W. (Civil) Maint

-sd-

E.E.W.W. (Civil) Maint

-sd-

Dy. H.E. Maint

Website: portal.mcgm.gov.in/tenders

Office of the: - Deputy Hydraulic Engineer (Maint),
Ghatkopar Yard, Cama lane,
Ghatkopar (West), Mumbai- 400 086.

INDEX

SECTION	DESCRIPTION	PG. NO.
1	E-TENDER NOTICE	03-07
2	ELIGIBILITY(POST-QUALIFICATION) CRITERIA	08-10
3	DISCLAIMER	11-13
4	INTRODUCTION	14-16
5	E-TENDER ONLINE SUBMISSION PROCESS	17-20
6	INSTRUCTIONS TO APPLICANTS	21-88
7	SCOPE OF WORK	89-90
8	BILL OF QUANTITIES	91-102
9	GENERAL CONDITIONS OF CONTRACT	103-156
10	SPECIFICATIONS	157-206
11	FRAUD AND CORRUPT PRACTICES	207-210
12	PRE-BID MEETING	211-212
13	LIST OF APPROVED BANKS	213-219
14	APPENDIX	220-242
15	SPECIAL CONDITIONS OF TENDER AND SPECIAL DIRECTIONS TO THE BIDDER	243-249
16	G.S.T & latest circulars	250-272

SECTION 1

E-TENDER NOTICE

MUNICIPAL CORPORATION OF GREATER MUMBAI
Hydraulic Engineer's Department

Bid No : 7200038419

E-TENDER NOTICE

Subject: Reconstruction of compound wall along Trunk Main on R. N. Gandhi Marg in N ward.

The Municipal Corporation of Greater Mumbai (MCGM) invites e-tender to appoint Contractor for the aforementioned work from contractors of repute, multidisciplinary engineering organizations i.e. eminent firm, Proprietary / Partnership Firms / Private Limited Companies / Public Limited Companies / Companies registered under the Indian companies' act 2013, the contractors registered with the Municipal Corporation of Greater Mumbai, (MCGM) in “**Class ‘AA’ and category ‘C-I’ as per old registration and Class - (II) as per new registration**” and from the contractors/firms equivalent and superior classes registered in Central or State Government / Semi Govt. Organization/Central or State Public Sector Undertakings, will be allowed subject to condition that, the contractors who are not registered with MCGM will have to apply for registering their firm within three months time period from the award of contract, otherwise their Bid Security i.e. **E.M.D (Earnest Money Deposit) will be forfeited / recovered and an amount equal to Registration Fee of respective class will be recovered as penalty. (Please refer circular U/No Dir/ES & P/1078/MC dtd. 30.11.2018 for contactors who are not registered with MCGM.)**

Bidding Process will comprise of THREE stages.

The application form can be downloaded from MCGM's portal (<http://portal.mcgm.gov.in>) on payment of **Rs.12272.00 (Rs. 10400 + 18% GST (1872.00) = 12272.00)**. The applicants not registered with MCGM are mandated to get registered (Vendor Registration) with MCGM for e-tendering process & obtain login credentials to participate in the online bidding process.

i) To download the application form, for those applicants not having vendor registration, need to apply first for vendor registration at the office of Account Officer (FAR), 3rd floor, Municipal Headquarter.

ii) Followed by SRM login ID and password to be obtained from Central Purchase Department (CPD), Office at Byculla, Bakariadda, Mumbai

iii) For e-Tendering registration, enrollment for digital signature certificates and user manual, please refer to respective links provided in ‘Tenders’ tab. Vendors can get digital signature

from any one of the Certifying Authorities (CA's) licensed by controller of certifying authorities namely, Safes crypt, IDRBT, National informatics center, TCS, CUSTOMS, MTNL, GNFC and e- Mudhra CA.

Name and location of work	Contract period	Estimated Cost of Project
Reconstruction of compound wall along Trunk Main on R. N. Gandhi Marg in N ward.	9 (Nine) months excluding Monsoon	Rs. 3,11,02,375.00

In terms of the 3 stage system of e-tendering, a Bidder will be required to deposit, along with its Bid, an Earnest Money Deposit of **Rs. 3,11,300.00 (Rupees three lac eleven thousand three hundreds only.)** (the "EMD"), refundable in accordance to the relevant clause of bid document, from the Bid Due Date, except in the case of the selected Bidder whose Bid Security/EMD shall be retained. The Bidders will have to provide Earnest Money Deposit through the payment gateways while submitting the bids. The Bid shall be summarily rejected if it is not accompanied by the Earnest Money Deposit. The e-tender is available on MCGM portal (<http://portal.mcgm.gov.in>) as mentioned in the Header Data of the tender.

As per THREE Packet systems, the document for Packet A & B is to be uploaded by the bidder in vendors' document online in Packet A, B and for packet C, bidder fill the data in item data tab in service line item via details and quotes his percentage figure variation. Packet A,B & C shall be opened on dates as mentioned in header data. All the responsive and eligible bidders if they so wish can be present at the time of opening of bids, in the office of Executive Engineer Water Works (Civil) Maint, Ghatkopar Yard office, Cama Lane, Ghatkopar West, Mumbai.-86. The Packet C shall be opened if bids submission in Packet A & B satisfies/includes all the requirements and same are found acceptable to the Authority.

The Municipal Commissioner reserves the right to reject all or any of the e- tender(s) without assigning any reasons at any stage.

The dates and time for submission and opening the bids are as shown in the Header Data. If there are any changes in the dates the same will be displayed on the MCGM Portal. (<http://portal.mcgm.gov.in>)

The Applicants interested for the above referred works may contact the Executive Engineer Water Works (Civil) Maintenance at the following address on any working day during office hours.

Office of the:- Deputy Hydraulic Engineer (Maint),
Ghatkopar Yard, Cama lane,
Ghatkopar (West), Mumbai- 400 086.

The applicants may wish to visit the site under reference located at “garden beside rotary club and nana nani park along the Trunk Main and opposite R.N. Gandhi school, Ghatkopar west in N-Ward.” of Mumbai and can collect the information of the present status from the Office of Executive Engineer, water works (Civil) Maint, who have invited the bids.

The MCGM reserves the rights to accept any of the e-tender or reject any or all the e-tender(s) received for above works, without assigning any reasons thereof. The information regarding above subject matter is available on Website of MCGM. (<http://portal.mcgm.gov.in/tenders>)

Note:

1. The amended tender condition for HE department approved by A.M.C. (P.) u/no. A.M.C. /P. 8108 dated 23.02.2022 (attached at DT page no. 261 to 272 will be superseded all the relevant condition mentioned in the tender document.

-sd/-

Dy. Hydraulic Engineer (Maintenance)

HEADER DATA

Tender Document No	7200038419
Name of Organization	Municipal Corporation of Greater Mumbai
Name Of Department	Dy. H.E. (Maintenance)
Subject	Reconstruction of compound wall along Trunk Main on R. N. Gandhi Marg in N ward.
Cost of Tender	Rs.12272.00 (Rs. 10400 + 18% GST (1872.00) = 12272.00).
Cost of E-Tender(Estimated Cost)	Rs. 3,11,02,375.00
Bid Security Deposit/ EMD	Rs. 3,11,300.00
Date of issue and sale of tender	From 22/10 / 2022 at 16.00 Hrs
Last date & time for sale of tender & Receipt of Bid Security Deposit	16 /11/ 2022 up to 12.00 Hrs
Submission of Packet A, B & Packet C (Online)	16/11/2022 up to 16.00 Hrs
Pre-Bid Meeting	02.11.2022
Opening of Packet A	17/11 / 2022 after 16.15 Hrs.
Opening of Packet B	17/11 / 2022 after 16.30 Hrs.
Opening of Packet C	25/11 / 2022 after 15.00 Hrs.
Address for communication	Deputy Hydraulic Engineer (Maintenance), Ghatkopar Yard, Cama lane, Ghatkopar (West), Mumbai- 400 086.
Venue for opening of bid	On line in the office of Executive Engineer (Civil) Maintenance, Ghatkopar Yard

This tender document is not transferable.

The MCGM reserves the rights to accept any of the application or reject any or all the application received for above subject without assigning any reason thereof.

Sd/-

Dy. H.E. (Maintenance)

SECTION 2

ELIGIBILITY (POST

QUALIFICATION)

CRITERIA

2.1 Technical Capacity

The tenderer(s) in their own name should have satisfactorily completed the work of similar nature in MCGM /Semi Govt. /Govt. & Public Sector Organizations during **last seven (7) years** ending last day of month previous to the date of issue of tender as a prime Contractor (or as a nominated sub-Contractor, where the subcontract had involved similar nature of work as described in the scope of works in this bid document, provided further that all other qualification criteria are satisfied)

- a) Three similar completed works each of value not less than the value equal to 30% of estimated cost put to tender i.e. **Rs. 93,30,712.50** each. **OR**
- b) Two similar completed works each of value not less than the value equal to 35% of estimated cost put to tender i.e. **Rs. 1,08,85,831.25** each **OR**
- c) One similar completed work of value equal and or not less than the 50% of estimated cost put to tender i.e. **Rs.1,55,51,187.50**

The value of completed works shall be brought to current costing level by enhancing the actual value of work at compound rate of 10 % per annum; calculated from the date of completion to the date of issue of tender.

*** In case of ongoing works to be considered, the bidder must have received payment bills of 80% of the contract sum for work/works executed last day of month previous to the one in which bids are invited**

2.2 Financial Capacity

Achieved an average annual financial turnover as certified by 'Chartered Accountant' (in all classes of civil engineering construction works only) equal to **30%** of the estimated cost i.e. **Rs. 93,30,712.50** of work in **last three (3) financial years** immediately preceding the Financial Year in which bids are invited.

To ascertain this, tenderer(s) shall furnish /upload the financial statement (Audited balance sheet) duly certified by Chartered Accountant

The value of completed works shall be brought to current costing level by enhancing the actual value of work at compound rate of 10% per annum; calculated from the date of completion to the date of issue of tenders.

2.3 Similar Experience:

This particular tender comes under the category of "Regular and Routine works".

Similar Experience for "Regular and Routine works". :

For assessing the technical capacity of Regular, Routine and Maintenance works; Similar work shall mean, the completed or ongoing works in Building Construction OR Building Maintenance such as repairs/retrofitting /structural repairs OR construction/repairs of Asphalt/ Concrete roads OR laying/rehabilitation of sewer lines along with allied components OR laying/rehabilitation of water pipe lines in Cast Iron/ M.S. pipes / HDPE/ MDPE pipes OR repairs/maintenance/ construction of culverts over nullah.

2.4 Bid Capacity:

The bid capacity of the prospective bidders will be calculated as under:

Assessed Available Bid Capacity = (A* N* 2 - B)

Where,

A = Maximum value of Civil Engineering works completed in any one year (year means Financial year) during **the last five years** (updated to the price level of the Financial year in which bids are invited at a compounded rate of 10% per year) taking into account the completed works;

Turnovers shall be updated to the price level of financial year 2021-22 (i.e. Value of A) as below:

Turnover of 2016-2017	X	1.46
Turnover of 2017-2018	X	1.33
Turnover of 2018-2019	X	1.21
Turnover of 2019-2020	X	1.10
Turnover of 2020-2021	X	1.00

N = Number of years prescribed for completion of the Project/Works, **excluding monsoon period**, for which these bids are being invited. (E.g. 7 months = 7/12 year) For every intervening monsoon 0.33 shall be added to N.

B = Value of existing commitments (only allotted works) on the last date of submission of bids as per bidding document and on-going works to be completed during the period of completion of the Project/Works for which these bids are being invited.

Note: The statement showing the value of existing commitments and on-going works as well as the stipulated period of completion remaining for each of the works listed should be attached along with certificates duly signed by the Engineer-in Charge, not below the rank of an Executive Engineer or equivalent.

Even though the bidders meet the above qualifying criteria, they are subject to be disqualified if they have:

- made misleading or false representation in the forms, statements and attachments submitted in proof of the qualification requirements; and/or
- Record for poor performance such as abandoning the works, not properly completing the contract, inordinate delays in completion, litigation history, or financial failures etc

SECTION 3

DISCLAIMER

DISCLAIMER

The information contained in this e-tender document or provided to Applicant(s), whether verbally or in documentary or any other form, by or on behalf of the Municipal Corporation of Greater Mumbai (MCGM), hereafter also referred as “The Authority “, or any of its employees or advisors, is provided to Applicant(s) on the terms and conditions set out in this e-tender and such other terms and conditions subject to which such information is provided.

This e-tender includes statements, which reflect various assumptions and assessments arrived at by the Municipal Corporation of Greater Mumbai (MCGM) in relation to the Project. Such assumptions, assessments and statements do not purport to contain all the information that each Applicant may require. This e-tender may not be appropriate for all persons, and it is not possible for the Municipal Corporation of Greater Mumbai (MCGM), its employees or advisors to consider the investment objectives, financial situation and particular needs of each party who reads or uses this e-tender. The assumptions, assessments, statements and information contained in this e-tender may not be complete, accurate, adequate or correct. Each Applicant should therefore, conduct its own investigations and analysis and should check the accuracy, adequacy, correctness, reliability and completeness of the assumptions, assessments, statements and information contained in this e-tender and obtain independent advice from appropriate sources.

Information provided in this e-tender to the Applicant(s) is on a wide range of matters, some of which may depend upon interpretation of law. The information given is not intended to be an exhaustive account of statutory requirements and should not be regarded as a complete or authoritative statement of law. The Municipal Corporation of Greater Mumbai (MCGM) accepts no responsibility for the accuracy or otherwise for any interpretation or opinion on law expressed here.

The Municipal Corporation of Greater Mumbai(MCGM), its employees and advisors make no representation or warranty and shall have no liability to any person, including any Applicant or Bidder, under any law, statute, rules or regulations or tort, principles of restitution or unjust enrichment or otherwise for any loss, damages, cost or expense which may arise from or be incurred or suffered on account of anything contained in this e-tender or otherwise, including the accuracy, adequacy, correctness, completeness or reliability of the e-tender and any assessment, assumption, statement or information contained therein or deemed to form part of this e-tender or arising in any way with pre-qualification of Applicants for participation in the Bidding Process. The Municipal Corporation of Greater Mumbai (MCGM) also accepts no liability of any nature whether resulting from negligence or otherwise howsoever caused arising from reliance of any

Applicant upon the statements contained in this e-tender.

The Municipal Corporation of Greater Mumbai (MCGM) may, in its absolute discretion but without being under any obligation to do so, update, amend or supplement the information, assessment or assumptions contained in this e-tender.

The issue of this e-tender does not imply that the Municipal Corporation of Greater Mumbai (MCGM) is bound to select and short-list pre-qualified Applications for Bid Stage or to appoint the selected Bidder or Concessionaire, as the case may be, for the Project and the Municipal Corporation of Greater Mumbai (MCGM) reserves the right to reject all or any of the Applications or Bids without assigning any reasons whatsoever.

The Applicant shall bear all its costs associated with or relating to the preparation and submission of its Application including but not limited to preparation, copying, postage, delivery fees, expenses associated with any demonstrations or presentations which may be required by The Municipal Corporation of Greater Mumbai (MCGM) or any other costs incurred in connection with or relating to its Application. All such costs and expenses will remain with the Applicant and the Municipal Corporation of Greater Mumbai(MCGM) shall not be liable in any manner whatsoever for the same or for any other costs or other expenses incurred by an Applicant in preparation or submission of the Application, regardless of the conduct or outcome of the Bidding Process.

SECTION 4

INTRODUCTION

INTRODUCTION

4.1 Background:

The Municipal Corporation of Greater Mumbai covers an area of 437.71sq.kms.with a population of **1.24 Crores as per census of 2011**. The metropolis accounts major portion of India's international trade and government's revenue, from being one of the foremost centers of education, science and technological research and advancement.

The Mumbai Metropolis has historic tradition of strong civic activism dedicated to the cause of a better life for all its citizens. And it is the Municipal Corporation of Greater Mumbai (MCGM), hereafter called the "corporation", is the primary agency responsible for urban governance in Greater Mumbai.

MCGM (The Authority) is one of the largest local self-governments in the Asian Continent. In observance of historic traditions of strong civic activism, with the change in time and living conditions to match with the urbanization, MCGM has mainly focused in providing almost all kinds of engineering services viz, Hydraulics, storm water drain, sewerage, water supply projects, roads, bridges, solid waste management, and environmental services. Beside this, the MCGM is also providing dedicated services in various segments such as Health, Primary Education as well as the construction and maintenance of Public Markets and Slaughter Houses.

MCGM is an organization having different departments, right from engineering depts. to health depts. Moreover MCGM has other dept. like education, market, fire brigade dept., Octroi and other such departments where quite a good number of staff members are working.

4.2 Scope of Work : MCGM is primarily an organization, which in the interest of citizens and with the speed of urbanization deals with the variety of the infrastructure services and delivered to the public by different departments like Water Supply Projects, Sewerage Projects, Hydraulic Engineers Department, Storm Water Drain/Roads and bridges and Building Construction etc.

➤ **This particular tender comes under the category of “Regular and Routine works”.**

Project specific scope of work includes:

Name of work: Reconstruction of compound wall along Trunk Main on R. N. Gandhi Marg in N ward.

1. Demolition of existing wall
2. Excavation for re-construction of wall
3. RCC work in foundation & Superstructure
4. SWD work
5. Plastering & Painting work.
6. M.S. work.
7. Footpath work
8. The trees affected in the alignment shall be removed by obtaining permission from Tree authority.
9. The successful tenderer (s) shall have to deposit the requisite amount with tree authority for faithful compliance of requirements.

Note:

1. Contractor shall appoint MCGM registered RCC Consultant and soil investigation agency at his own cost to carry out the necessary designs, built drawings and shall get the drawings approved by the office of Executive Engineer W.W. (Civil) Maint.
2. The bidder shall note that the total station survey at the proposed tender work site inclusive of all existing surrounding details shall be carried out before starting of the work and after completion of work free of cost; no extra payment shall be made for the same.

SECTION 5

E-TENDERING ONLINE

SUBMISSION PROCESS

E-TENDERING ONLINE SUBMISSION PROCESS

The terminology of e-Tendering is solely depending upon policies in existence, guidelines and methodology adopted since decades. The SRM is only change in process of accepting and evaluation of tenders in addition to manual. The SAP module to be used in this E-tendering is known as Supplier Relationship Module (SRM). SRM is designed and introduced by ABM Knowledge ware Ltd. who will assist MCGM in throughout the tendering process for successful implementation.

NOTE: This tendering process is covered under Information Technology ACT & Cyber Laws as applicable

(1) In e-tendering process some of the terms and its definitions are to be read as under wherever it reflects in online tendering process.

Start Date read as “Sale Date”

End Date read as “Submission Date”

Supplier read as “Contractor/bidder”

Vendor read as “Contractor/bidder”

Vendor Quotation read as “Contractors Bid/Offer”

Purchaser read as “Department/MCGM”

I. Before entering in to online tendering process, the bidders should complete the registration process so as to get User ID for E-tendering links. For this, the bidders can access through Supplier registration via MCGM Portal.

There are two methods for this registration :(II and III)

II. Transfer from R3 (registered contractors with MCGM) to SRM

a. Contractors already registered with MCGM will approach to Vendor Transfer cell.

b. Submit his details such as (name, vendor code, address, registered Email ID, pan card etc.) to Vendor transfer cell.

c. MCGM authority for Vendor Transfer, transfers the Vendor to SRM application from R3 system to SRM system.

d. Transferred Vendor receives User ID creation link on his supplied mail Id.

e. Vendor creates his User ID and Password for e-tendering applications by accessing link sent to his mail ID.

III. Online Self Registration (Temporary registration for applicant not registered with MCGM)

- a. Vendor fills up Self Registration form via accessing MCGM portal.
- b. Vendor Transfer cell (same as mentioned above) accesses Supplier Registration system and accepts the Vendor request.
- c. Accepted Vendor receives User ID creation email with Link on his supplied mail Id.
- d. Vendor creates his User ID and Password for e-tendering application.

IV. CONTRACTORS BIDDING: Applicant will Quote and Upload Tender Documents

1. Access e-tender link of SRM Portal
2. Log in with User ID and Password
3. Selects desired Bid Invitation (he wants to bid)
4. To download tender documents bidders will have to pay online Tender fee. The same can be done by accessing Pay Tender Fees option. By this one will be able to pay Tender fee through Payment Gateway-If transaction successful bidders can register his interest to participate. Without Registration one cannot quote for the Bid/Tender.
5. Applicant will download Tender Documents from Information from purchaser tab by accessing Purchaser document folder through collaboration 'C' folder link.
6. Applicant will upload Packet **A** related and Packet **B** related Documents in Packet **A** and Packet **B** folder respectively by accessing these folders through "My Notes" Tab and collaboration folder link.
7. All the documents uploaded have to be digitally signed and saved. bidders can procure there digital signature from any certified CA's in India.
8. Bid security deposit/EMD and ASD, if applicable, should be paid online as mentioned in tender.
9. For commercial details (in Packet **C**) bidders will fill data in Item Data tab in Service Line Item via details and quotes his "Percentage Variation" (i.e.% quoted) figure.(If entered '0' it will be treated as at par. By default the value is zero only.
10. Applicants to check the bid, digitally signs & save and submit his Bid Invitation.

11. Applicants can also save his uploaded documents/commercial information without submitting the BID for future editing through 'HOLD' option.
12. Please note that "Hold" action do not submit the Bid.
13. Applicants will receive confirmation once the Bid is submitted.
14. Bid creator (MCGM) starts Bid Opening for Packet A after reaching End Date and Time and Bid Evaluation process starts.

As per Three Packet system, the documents for Packet A & B are to be uploaded by the tenderer in 'Vendor's document' online in Packet A & B. Before purchasing/ downloading the tender copy, tenderer may refer to post- Qualification criteria mentioned in e-Tender Notice.

The tenderer shall pay the EMD/Bid Security through payment gateways before submission of Bid and shall upload the screenshot of receipt of payment in Packet 'A' instead of paying the EMD at any of the CFC centers in MCGM Ward Offices.

The e-tender is available on MCGM portal, <http://portal.mcgm.gov.in>, as mentioned in the Header Data of the tender. The tenders duly filled in should be uploaded and submitted online on or before the end date of submission. The Packet 'A', Packet 'B' & Packet 'C' of the tenderer will be opened as per the time-table shown in the Header Data in the office of Executive Engineer Water Works (Civil) Maint.

The Municipal Commissioner reserves the right to reject all or any of the e-Tender(s) without assigning any reason at any stage. The dates and time for submission and opening the tenders are as shown in the Header Data. If there are any changes in the dates the same will be displayed on the MCGM Portal (<http://portal.mcgm.gov.in>).

SECTION 6

INSTRUCTIONS TO

APPLICANTS

INSTRUCTIONS TO APPLICANTS

6.1 Scope of Application

The Authority wishes to receive Applications for Qualification in order to SELECT experienced and capable Applicants for the Bid Stage.

6.2 Eligibility of Applicants

The Municipal Corporation of Greater Mumbai (MCGM) invites e-tender to appoint Contractor for the aforementioned work from contractors of repute, multidisciplinary engineering organizations i.e. eminent firm, Proprietary/Partnership Firms/ Private Limited Companies/ Public Limited Companies/Companies registered under the Indian companies' act 2013, the contractors registered with the Municipal Corporation of Greater Mumbai, (MCGM) in “**Class ‘AA’ and category ‘C-I’ as per old registration and Class - (II) as per new registration**” and from the contractors/firms equivalent and superior classes registered in Central or State Government/Semi Govt. Organization/Central or State Public Sector Undertakings, will be allowed subject to condition that, the contractors who are not registered with MCGM will have to apply for registering their firm within three months' time period from the award of contract, otherwise their Bid Security i.e. **E.M.D (Earnest Money Deposit) will be forfeited/recovered and an amount equal to Registration Fee of respective class will be recovered as penalty.**

To be eligible for pre-qualification and short-listing, an Applicant shall fulfill the following conditions of eligibility:

1. For Regular, Routine and Maintenance works:

1.1 Technical Capacity

The tenderer(s) in their own name should have satisfactorily completed the work of similar nature in MCGM /Semi Govt. /Govt. & Public Sector Organizations during last seven (7) years ending last day of month previous to the date of issue of tender as a prime Contractor (or as a nominated sub-Contractor, where the subcontract had involved similar nature of work as described in the scope of works in this bid document, provided further that all other qualification criteria are satisfied)

- a) Three similar completed works each of value not less than the value equal to 30% of estimated cost put to tender i.e. Rs. 93,30,712.50 each. **OR**
- b) Two similar completed works each of value not less than the value equal to 35% of estimated cost put to tender i.e. Rs. 1,08,85,831.25 each **OR**
- c) One similar completed work of value equal and or not less than the 50% of estimated cost put to tender i.e. Rs. 1,55,51,187.50

The value of completed works shall be brought to current costing level by enhancing the actual

value of work at compound rate of 10 % per annum; calculated from the date of completion to the date of issue of tender.

*** In case of ongoing works to be considered, the bidder must have received payment bills of 80% of the contract sum for work/works executed last day of month previous to the one in which bids are invited**

2.2 Financial Capacity

Achieved an average annual financial turnover as certified by ‘Chartered Accountant’ (in all classes of civil engineering construction works only) equal to **30%** of the estimated cost i.e. **Rs. 93,30,712.50** of work in **last three (3) financial years** immediately preceding the Financial Year in which bids are invited.

To ascertain this, tenderer(s) shall furnish /upload the financial statement (Audited balance sheet) duly certified by Chartered Accountant

The value of completed works shall be brought to current costing level by enhancing the actual value of work at compound rate of 10 % per annum; calculated from the date of completion to the date of issue of tenders.

1.3 Similar Experience for “Regular and Routine works”.

For assessing the technical capacity of Regular, Routine and Maintenance works; Similar work shall mean, the completed or ongoing works in Building Construction OR Building Maintenance such as repairs/retrofitting /structural repairs OR construction/repairs of Asphalt/ Concrete roads OR laying/rehabilitation of sewer lines along with allied components OR laying/rehabilitation of water pipe lines in Cast Iron/ M.S. pipes / HDPE/ MDPE pipes OR repairs/maintenance/ construction of culverts over nullah.

2. For Original and New construction works: (Not Applicable to this Tender)

~~—2.1 Technical Capacity (Project Experience):~~

~~The tenderer(s) in their own name should have satisfactorily completed the work of similar nature in MCGM /Semi Govt. /Govt. & Public Sector Organizations during last seven (7) years ending last day of month previous to the date of issue of tender as a prime Contractor (or as a nominated sub-Contractor, where the subcontract had involved similar nature of work as described in the scope of works in this bid document, provided further that all other qualification criteria are satisfied)~~

~~a) Three similar completed works each of value of not less than the value equal to 30% of estimated cost put to tender.~~

OR

b) ~~Two similar completed works each of value of not less than the value equal to 40 % of estimated cost put to tender.~~

OR

e) ~~One completed work of value of not less than the value equal to 60% of estimated cost put to tender.~~

~~The value of completed works shall be brought to current costing level by enhancing the actual value of work at compound rate of 10 % per annum; calculated from the date of completion to the date of issue of tenders.~~

~~***In case of ongoing works to be considered, the bidder must have received payment bills of 80% of the contract sum for the work/works executed last day of month previous to the one in which bids are invited.**~~

2.2 Financial Capacity

~~Achieved an average annual financial turnover as certified by Chartered Accountant (in all class of civil engineering construction work only) equal to 30% of the estimated cost of work in last three (3) financial years immediately preceding the Financial Year in which bids are issued.~~

~~To ascertain this, tenderer(s) shall furnish /upload the financial statement (Audited balance sheet) duly certified by Chartered Accountant.~~

~~The value of completed works shall be brought to current costing level by enhancing the actual value of work at compound rate of 10 % per annum; calculated from the date of completion to the date of issue of tenders.~~

~~2.3 Similar experience is spelt in definite sense, such as-~~

~~Similar work shall mean for the completed works in building construction or building maintenance such as repairs / retro fitting / structural repairs or construction / repairs of asphalt / concrete roads or laying a sewer lines along with alike components or laying / rehabilitation of water pipe lines in cast Iron / M.S pipe / HDP / MDP pipes or repairs / maintenance / construction of culverts over Nalla or any civil engineering works as classified.~~

C) Bid Capacity:

~~The bid capacity of the prospective bidders will be calculated as under:~~

~~Assessed Available Bid Capacity = (A * N * 2 - B)~~

~~Where,~~

~~A = Maximum value of Civil Engineering works completed in any one year (year means Financial year) during the last five years (updated to the price level of the Financial year in which bids are invited at a compounded rate of 10% per year) taking into account the completed works.~~

~~N = Number of years prescribed for completion of the Project/Works, excluding monsoon period, for which these bids are being invited. (E.g. 7 months = 7/12 year) For every intervening monsoon 0.33 shall be added to N.~~

~~B = Value of existing commitments (only allotted works) on the last date of submission of bids as per bidding document and on going works to be completed during the period of completion of the Project/Works for which these bids are being invited.~~

~~Note: The statement showing the value of existing commitments and on going works as well as~~

~~the stipulated period of completion remaining for each of the works listed should be attached along with certificates duly signed by the Engineer in Charge, not below the rank of an Executive Engineer or equivalent.~~

~~Even though the bidders meet the above qualifying criteria, they are subject to be disqualified if they have:~~

- ~~—— made misleading or false representation in the forms, statements and attachments submitted in proof of the qualification requirements; and/or~~
- ~~—— Record for poor performance such as abandoning the works, not properly completing the contract, inordinate delays in completion, litigation history, or financial failures etc~~

D . Equipment Capabilities as required for this work

a) Regular and Routine works: The successful bidder will make the arrangements of the required equipment on the day of commencement or with respect to the progress of the work in phases, as per the instructions of site in charge. The successful bidder and, to that effect he will ensure commitment on an undertaking on Rs.500 stamp paper to be submitted along with the Bid in Packet B. However, this condition in no way shall dilute the respective condition in Registration Rules of MCGM.

b) New and Original Works: The bidder should, undertake their own studies and furnish with their bid, a detailed construction planning and methodology supported with assessment study of requirements of equipment/plants & machineries to allow the employer to review their proposal. The bidder will ensure his commitment to make the arrangements of the required equipment on the day of commencement or with respect to the progress of the work in phases, as per the instructions of site in charge on an undertaking on Rs.500 stamp paper to be submitted along with the Bid in Packet B. However, this condition in no way shall dilute the respective condition in Registration Rules of MCGM

c) Special Works: The concerned Ch. Eng. Shall enlist the equipments in the tender document justified for the project and ensure the capacity of the bidder for the same with the approval of concerned AMC.

Note:

- 1. Bidders shall submit the undertaking for equipment capability and other undertakings such as on a single Rs 500/- stamp paper**
- 2. Insistence of availability of equipment/plants at a particular distance from site should not be made in the tender documents.**

6.3 Classes available for Civil Contractors (As per old registration rules)

<i>Category</i>		<i>Description of work</i>
Building	C-I	Building & allied works, pile foundation, precast or cast in situ concrete works, diaphragm walls, ground anchors and allied works, water proofing, leak proofing of various types of structures.
Bridges	C-II	Bridges including road over bridges, flyover, foot over bridges, subways and culverts.
Roads	C-III	Road works of various types including storm water drains culverts and training/ de-silting of nallas, underground storm water drains.
Water Supply	C-IV	Laying of water mains, rising mains, water pumping stations, reservoirs, head works.
Sewerage	C-V	Laying of sewers, rising main & underground storm water drains, sewage pumping stations, treatment plants, outfalls etc.

6.4 Class available according to the limits of works, amount of solvency, registration fees & amount of standing deposit prescribed for each class (As per old registration rules).

<i>Class</i>	<i>Works limit</i>	<i>Solvency amount</i>	<i>Scrutiny fees</i>	<i>Registration fees</i>	<i>Renewal fees</i>	<i>Standing deposit</i>
	<i>Rs</i>	<i>Rs</i>	<i>Rs</i>	<i>Rs</i>	<i>Rs</i>	<i>Rs</i>
		<i>In Lacs</i>				
AA	Without limit	60	2000	4000	2000	7,50,000.00
A	upto 3 Crores	30	2000	4000	2000	4,50,000.00
B	upto 1 Crore	20	1000	2000	1000	3,00,000.00
C	upto 50 Lacs	15	1000	2000	1000	1,50,000.00
D	upto 25 Lacs	10	1000	2000	1000	1,12,500.00
E	upto 10 Lacs	5	1000	2000	1000	45,000.00

6.5 MINIMUM FINANCIAL AND ORGANIZATIONAL REQUIREMENTS FOR CIVIL ENGINEERING DISCIPLINE AS PER REFRAMED RULES

MINIMUM FINANCIAL AND ORGANIZATIONAL REQUIREMENTS FOR CIVIL ENGINEERING DISCIPLINE AS PER REFRAMED RULES

Sr. No.	Class	Upper limit of Tendering	Minimum Solvency	Total Turn-Over in Last 3 Years	Cost of Single Work Completed within Last 3 years	No. of Civil Engineers Employee
1	2	3	4	5	6	7
1	I(A)	Without Limit	200	4000	1500	4 Graduate with 5 years or 1 Graduate with 5 years and 5 Diploma Holder with 7 years experience.
2	I(B)	2500	175	2500	750	3 Graduate with 5 years or 1 Graduate with 5 years and 4 Diploma Holder with 7 years experience.
3	I(C)	1500	150	1500	300	3 Graduate with 5 years or 1 Graduate with 5 years and 4 Diploma Holder with 7 years experience.
4	II	750	100	750	150	2 Graduate with 3 years or 1 Graduate with 3 years and 3 Diploma Holder with 5 years experience.
5	III	300	75	300	90	2 Graduate with 3 years or 1 Graduate with 3 years and 2 Diploma Holder with 5 years experience.
6	IV	150	40	150	50	1 Graduate with 1 year or 1 Diploma Holder with 3 years experience.
7	IV(A)	90	25	90	30	1 Graduate with 1 year or 1 Diploma Holder with 3 years experience.
8	V	50	15	50	15	1 Graduate with 1 year or 1 Diploma Holder with 3 years experience.
9	V(A)	30	8	0	0	1 Fresh Graduate or 1 Fresh Diploma Holder.

10	VI	15	2	0	0	1 Fresh Graduate or 1 Fresh Diploma Holder.
11	VII	10	1	0	0	1 Fresh Graduate or 1 Fresh Diploma Holder.
12	VIII	5	0.5	0	1 Fresh Graduate or 1 Fresh Diploma Holder.
13	IX	3	0.25	1 Fresh Graduate or 1 Fresh Diploma Holder.

Note:- 1) A Solvency Certificate registered beyond 12 months from the date of its issue will not be considered. Certificate of Solvency (in Hindi/Marathi/English) shall be obtained from scheduled or Nationalise Bank, in the name of the applicant/Firm/Company only.

2) Turn-over shall be supported with work completion/performance certificate of civil works only. In case of works carried out in private organization, T.D.S. Certificate is essential and certificate from License Architect is necessary.

3) Cost of single work criteria will be governed as given in below table

6.6 SINGLE WORK CRITERIA (Rs. In Lakhs) (As per New registration rules)

SINGLE WORK CRITERIA (Rs. In Lakhs) (As per New registration rules)					
Sr.No.	Class	Upper limit of Tendering	Single work criteria(Applicant has to fulfill one of the following criteria)		
			Minimum Cost of Single Work Completed (within Last 3 years)	Cost of Two Works Completed costing not less than (Within Last 3 years)	Cost of Three Works Completed costing not less than (Within Last 3 years)
1	2	3	4	5	6
1	I(A)	Without Limit	1500	750	500
2	I(B)	2500	750	400	250
3	I(C)	1500	300	150	100
4	II	750	150	75	50
5	III	300	90	50	30
6	IV	150	50	25	20
7	IV(A)	90	30	15	10
8	V	50	15	8	5

6.7 Equipment Capabilities as required for this work

6.8 Equipment Capability:

Sr. No.	Equipment Owned	Requirements
1	Mortar mixer	02Nos.
2	Sand washing machine	02 No.
3	Welding machineries	1 Nos.
4	Dumpers	02 No.
5	Water tank (10000 Litter)	1 Nos.

The successful bidder will make the arrangements of the required equipment on the day of commencement or with respect to the progress of the work in phases, as per the instructions of site in charge. The successful bidder and, to that effect he will ensure commitment on an undertaking on Rs.500 stamp paper to be submitted along with the Bid in Packet B. However, this condition in no way shall dilute the respective condition in Registration Rules of MCGM.

Note:

1. Bidders shall submit the undertaking for equipment capability and other undertakings as such on a single Rs.500/- stamp paper.

6.9 Technical Personnel

The contractor and/or its managerial staff should have qualification/experience appropriate to the function they fulfill. The minimum standard shall be increased by asking that at least one number or more of the contractor or its managerial staff have acquired qualifications or work experience to the needs of the contract. The minimum standard may also state that the person or persons responsible for managing the works must have a minimum of no's of years experience working on similar nature of projects.

For fixing requirement of Technical Staff as required for this work.

(A) General Guidelines for Fixing Requirement of Technical Staff

Cost of work (Rs in Crore)	Requirement of Technical Staff (of Major +Minor Component)		Minimum Experience(years)	Designation
	Qualification	Number		
more than 100	<i>i)</i> Graduate Engineer(Major component)	1	20	Project Manager in major discipline of engineering
	<i>ii)</i> Graduate Engineer	2+1	12	Deputy Project Manager in major discipline of engineering
	<i>iii)</i> Graduate Engineer or Diploma Engineer	4	5	Project/Site Engineer
	<i>iv)</i> Graduate Engineer	2	10	Quality Engineer
		1+1	8	
		<i>v)</i> Diploma Engineer	1	8
	<i>vi)</i> Graduate Engineer	1+1	6	Project Planning/Billing Engineer
more than 50 to 100	<i>i)</i> Graduate Engineer	1	20	Project Manager
	<i>ii)</i> Graduate Engineer	1+1	12	Deputy Project Manager

	iii) Graduate Engineer or Diploma Engineer	2+1	5 Or 10	Project/Site Engineer
	iv) Graduate Engineer	1	8	Quality Engineer surveyor
	v) Diploma Engineer	1	8	
	vi) Graduate Engineer	1 + 1	6	
More than 20 to 50	i) Graduate Engineer	1	20	Project Manager
	ii) Graduate Engineer or Diploma Engineer	1 + 1	5 Or 10	Project/Site Engineer
	iv) Graduate Engineer	1	8	Quality Engineer
	v) Diploma Engineer	1	8	surveyor
	vi) Graduate Engineer	1	6	Project Planning/Billing Engineer

Note

1. "Cost of work, in the table above, shall mean the agreement amount of the work.
2. Rate of recovery in case of non-compliance of the clause be stipulated at following rates

Sr. No	Qualification	Experience(years)	Rate of Recovery
1	Project Manager with degree	20	Rs.60000/-p.m.
2	Deputy Project Manager with degree	12	Rs.40000/-p.m.
3	Project/Site Engineer(Degree/Diploma)	5 or 10 respectively	Rs.25000/-p.m.

3	Quality Graduate Engineer	8	Rs.25000/-p.m.
4	Surveyor	8	Rs.15000/-p.m.
5	Project Planning/ Billing Engineer	6	Rs.20000/-p.m.

3.Nothing extra need to be added while preparing market rate justified amount of the work if stipulation is made as per above recommended scale of technical staff.

4. Requirement of technical staff and their experience can be varied depending upon cost and complexity of the work by competent authority i.e. Chief Engineer with recorded reasons.

5 The failure in providing experienced technical and /professional ability personnel and even ignoring the instruction of the Engineer-in-charge shall be linked to penalization. Such disobeying attitude of the contractor shall also be reported to Vigilance/Registration & Monitoring department

B) General guidelines for Fixing Requirement of Technical Staff

Cost of work (Rs in Crore)	Requirement of Technical Staff		Minimum Experience(year)	Designation
	Qualification	Number		
10 to 20	i)Project Manager with degree in corresponding discipline of Engineering	1	10	Principal Technical Representative
	ii)Graduate Engineer	1	5	Technical Representative
	iii) Graduate Engineer or	2	2	Project/Site Engineer and
	Diploma Engineer	2	5	Project Planning/ billing Engineer
5 to10	i) Graduate Engineer	1	5	Principal Technical Representative
	ii) Graduate Engineer or	2	2	Project/Site Engineer
	Diploma Engineer	2	5	Engineer

More than 1.5 to 5	i) Graduate Engineer	1	5	Principal Technical Representative
	ii) Graduate Engineer or Diploma Engineer	1	2	Project/Site Engineer
		1	5	Billing Engineer
Up to 1.5	i) Graduate Engineer or Diploma Engineer	1	2	Principal Technical Representative
		1	5	Project/Site Engineer/ Billing Engineer

Notes- 1 “Cost of work”, in table above, shall mean the agreement amount of the work.

2. Rate of recovery in case of non-compliance of the clause be stipulated at following rates:-

Sr.No	Qualification	Experience(years)	Rate of Recovery
1	Project Manager with degree	10	Rs.30000/-p.m.
2	Graduate Engineer	5	Rs.25000/-p.m.
3	Graduate Engineer	2	Rs.15000/-p.m.
4	Diploma Engineer	5	Rs.15000/-p.m.

3. Nothing extra need to be added while preparing market rate justified amount of the work if stipulation is made as per above recommended scale of technical staff.

4. Requirement of technical staff and their experience can be varied depending upon cost and complexity of the work by competent authority i.e. Chief Engineer with recorded reasons.

6.10 TIME PERIOD OF THE PROJECT:

Entire project should be completed and delivered within **09 (nine) months (EM)** of time from the date of award of contract including Monsoon.

The time allowed for carrying out the work as entered in the Tender shall be strictly observed by the Contractor and shall be reckoned from the date on which the Letter of Acceptance is given to the Contractor. The work shall throughout the stipulated period of the Contract be proceeded with all due diligence as time being deemed to be the essence of the contract on the part of the Contractor. On failing to do so, the Contractor shall pay as compensation an amount which shall be governed as per Clause - 8(e) of Standard General Conditions of Contract.

~~The Contractor should complete the work as per phase given below :-~~

————— $\frac{1}{4}$ of the work in ————— .. ————— $\frac{1}{4}$ of the time
————— $\frac{1}{2}$ of the work in ————— .. ————— $\frac{1}{2}$ of the time
————— $\frac{3}{4}$ of the work in ————— .. ————— $\frac{3}{4}$ of the time
————— Full of the work in ————— .. ————— Full of the time

Full work will be completed in **9 (nine) months excluding** monsoon.

The programme for completion of work shall be a part of the Contract Document in the form of Bar Chart / GANTT Chart. The Contractor is supposed to carry out the work and keep the progress as per Bar Chart/GANTT Chart. The Contractor shall complete the work as per the Schedule given in the Contract and the programme submitted by the Contractor.

6.11 Contract Execution

All required documents for execution of the contract shall be submitted within 30 days from the date of issue of letter of acceptance. If the documents are not submitted within the stipulated time a penalty of **Rs 5000/- per day** will be applicable to the contractor. All contract documents need to be duly affixed with stamp duty properly signed along with evidence/proof of payment of security/contract deposit/ within 30 days from the date of letter of acceptance received by him

6.12 If the amount of the Contract Deposit to be paid above is not paid within 30 days from the date of issue of Letter of Acceptance, the Tender / Contractor already accepted shall be considered as cancelled and legal steps be taken against the contractor for recovery of the amounts.

6.13 The amount of Security Deposit retained by the MCGM shall be released after expiry of period up to which the contractor has agreed to maintain the work in good order is over. In the event of the contractor failing or neglecting to complete the rectification work within the period up to which the contractor has agreed to maintain the work in good order, the amount of security deposit retained by MCGM shall be adjusted towards the excess cost incurred by the Department on rectification work.

6.14 Action when whole of security deposit is forfeited:

In any case in which under any Clause of this contract, the contractor shall have rendered himself liable to pay compensation amounting to the whole of this security deposit whether paid in one sum or deducted by installments or in the case of abandonment of the work owing to serious illness or death of the contractor or any other cause, the Engineer on behalf of the Municipal Commissioner shall have power to adopt any of the following process, as he may deem best suited to the interest of MCGM -

- (a) To rescind the contract (for which recession notice in writing to the contractor under the head of Executive Engineer shall be conclusive evidence) and in that case, the security deposit of the contract shall stand forfeited and be absolutely at the disposal of MCGM.
- (b) To carry out the work or any part of the work departmentally debiting the contractor with the cost of the work, expenditure incurred on tools and plant, and charges on additional supervisory staff including the cost of work-charged establishment employed for getting the un-executed part of the work completed and crediting him with the value of the work done departmentally in all respects in the same manner and at the same rates as if it had been carried out by the contractor under the terms of his contract. The certificate of the Executive Engineer as to the costs and other allied expenses so incurred and as to the value of the work so done departmentally shall be final and conclusive against the contractor.
- (c) To order that the work of the contractor be measured up and to take such part thereof as shall be un-executed out of his hands, and to give it to another contractor to complete, in which case all expenses incurred on advertisement for fixing a new contracting agency, additional supervisory staff including the cost of work charged establishment and the cost of the work executed by the new contract agency will be debited to the contractor and the value of the work done or executed through the new contractor shall be credited to the contractor in all respects and in the same manner and at the same rates as if it had been carried out by the contractor under the terms of his contract. The certificate of the Executive Engineer as to all the cost of the work and other expenses incurred as aforesaid for or in getting the un-executed work done by the new contractor and as to the value of the work so done shall be final and conclusive against the contractor.

In case the contract shall be rescinded under Clause (a) above, the contractor shall not be entitled to recover or be paid any sum for any work therefore actually

performed by him under this contract unless and until the Executive Engineer shall have certified in writing the performance of such work and the amount payable to him in respect thereof and he shall only be entitled to be paid the amount so certified. In the event of either of the courses referred to in Clause (b) or (c) being adopted and the cost of the work executed departmentally or through a new contractor and other allied expenses exceeding the value of such work credited to the contractors amount of excess shall be deducted from any money due to the contractor, by MCGM under the contract or otherwise, howsoever, or from his security deposit or the sale proceeds thereof provided, however, the contractor shall have no claim against MCGM even if the certified value of the work done departmentally or through a new contractor exceeds the certified cost of such work and allied expenses, provided always that whichever of the three courses mentioned in clauses (a), (b) or (c) is adopted by the Executive Engineer, the contractor shall have no claim to compensation for any loss sustained by him by reason of his having purchase or procured any materials or entered in to any engagements or made any advance on account of or with a view to the execution of the work or the performance of the contract.

6.14.1 Contract may be rescinded and security deposit forfeited for bribing a public officer or if contractor becomes insolvent

If the contractor assigns or sublets his contracts or attempt so to do, or become insolvent or commence any proceeding to get himself adjudicated and insolvent or make any composition with his creditors, or attempt so to do or if bribe, gratuity, gift, loan, perquisite, reward or advantage, pecuniary or otherwise, shall either directly or indirectly be given promised or offered by the contractor or any of his servants or agents through any public officer, or person in the employ of MCGM/Govt. in any way relating to his office or employment, or if any such officer or person shall become in any way directly or indirectly interested in the contract the Engineer In-charge may thereupon, by notice in writing rescind the contract and the Security Deposit of the Contractor shall there upon stand forfeited and be absolutely at the disposal of MCGM and the same consequences shall ensure as if the contract had been rescinded under above clause J hereof; and in addition the contractor shall not be entitled to recover or be paid for any work therefore actually performed under the contract.

6.15 Submission of Tenders

PACKET – A

The Packet 'A' shall contain scanned certified copies of the following documents

Scrutiny of this packet will be done strictly with reference to only the scanned copies of Documents uploaded online in packet 'A'

- a) Valid Registration Certificate.
- b) Valid Bank Solvency Certificate of Minimum Solvency amount as governed by Registration Rules in force for respective Class of Contractor for Civil and M&E works.
- c) A document in support of Registration under GST Act 2017.
- d) Certified copies of valid 'PAN' documents and photographs of the individuals, owners, Karta of Hindu undivided Family, firms, private limited companies, registered co-operative societies, partners of partnership firms and at least two Directors, if number of Directors are more than two in case of Private Limited Companies, as the case may be. However, in case of Public Limited companies, Semi Government Undertakings, Government Undertakings, no 'PAN' documents will be insisted.
- e) Latest Partnership Deed in case of Partnership firm duly registered with Chief Accountant (Treasury) of MCGM.
- f) The Registered power of attorney shall be submitted in the name of person who is submitting the bid.

The bidders shall categorically provide their Email-ID in packet 'A'.

NOTE:

- If the tenderer(s) withdraw tender offer during the tender validity period, his entire E.M.D shall be forfeited.
- **If it is found that the tenderer has not submitted required curable documents in Packet "A" then, the shortfalls will be communicated to the tenderer through e-mail only and compliance required to be made within a time period of three working days otherwise they will be treated as non-responsive.**

PACKET – B

The Packet 'B' shall contain scanned certified copies of the following documents –

- a) The list of similar type of works as stated in para 'A' of Post qualification successfully completed during the last Seven (07) years in prescribed proforma, in the role of prime contractor. Information furnished in the prescribed proforma (**Proforma – I**) shall be supported by the certificate duly self-attested. Documents stating that it has successfully

completed during the last Seven (07) years at least one contract of similar works as stated in para 'A' of Post qualification.

- b) Annual financial turnover for **preceding Three financial years as certified by Chartered Accountant** preceding the Financial Year in which bids are invited. **Copies of Applicants duly audited balance sheet and profit and loss account for the preceding Three financial years preceding the Financial Year in which bids are invited. (Proforma – II).**
- c) Documents stating that, it has access to or has available liquid assets, unencumbered assets, lines of credit and other financial means (independent of any contractual advance payment) sufficient to meet the construction cash flow requirements for the subject contract in the event of stoppage, start-up, or other delay in payment, of the minimum **15%** of the cost of the work tendered for, net of the tenderer's commitment of other contracts (Certificate from Bankers / C.A./Financial Institution shall be accepted as a evidence).
- d) The bidder shall give undertaking on Rs 500/-stamp paper that it is his/their sole responsibility to arrange the required machineries either owned/on lease or hire basis, at site before start of the work. Information about ownership, or assured access (through hire, lease, and other commercial means) to key items of equipments in Proforma V/A. Information about ownership in Proforma V/B original) as per 6.8, as stated in post qualification criteria.
 - i) **Regular and Routine works:** The successful bidder shall make the arrangements of the required equipment on the day of commencement or with respect to the progress of the work in phases, as per the instructions of site in charge. The successful bidder and, to that effect he will ensure commitment on an undertaking on Rs.500 stamp paper to be submitted along with the Bid in Packet B. However, this condition in no way shall dilute the respective condition in Registration Rules of MCGM.
 - ii) **New and Original works:** - The bidder should undertake their own studies and furnish with their bid a detailed construction planning and methodology supported assessment study of requirements of equipment/plants & machineries to allow the employer to review their proposal. The bidder will ensure his commitment to make arrangements of the required equipment on the day of commencement or with respect to the progress of the work in phases as per the instructions of the site in charge on an undertaking on Rs 500 stamp paper to be submitted along with the bid in packet B However this condition in no way shall dilute respective conditions in registration of rules.

- iii) **Special Works:** The concerned Ch.Eng. shall enlist the equipments in the tender document justified for the project and ensure the capacity of the bidder for the same with the approval of concerned AMC
- e) The list of the “Technical Personnel” with their qualification, working in the tenderers establishment as per proforma IV.
- f) Details of works in hand and for which bid already submitted (**Proforma VI-A & VI-B**) (original), along with copies of work orders & attested copies of percentage of works completed or part thereof.
- g) Statement showing assessed available Bid Capacity.
- h) The separate undertaking on Rs.500/- stamp paper as per the proforma annexed in Annexure B (Pre-Contract Integrity pact), C (Indemnity bond), D (Best price), A and (Irrevocable Undertaking) and statement that bidder is conversant to onsite situations and difficulty ~~and has inspected the site personally~~ and accordingly the bid is submitted. The undertaking shall also include that, he will submit license certificate from office of labour commissioner as stated in clause 6.32 after issue of work order and before commencing the work, if the work allotted to him.
- i) Details of certificate issuing Authorities in (Proforma X).
- j) Pre bid meeting minutes, signed copy of Addendum if any.
- k) The tenderers shall upload work plan as per the following outline:
1. GANTT chart/ PERT/ CPM chart showing the completion of work within prescribed time period, considering major activities.
 2. Organizational set up envisaged by the contractors.
 3. Plant & equipment proposed to be deployed for this work.
 - 4 .Site Offices and Laboratories proposed to be set up.
 5. A note on how the whole work will be carried out (work plan including methodology).
 6. Quality management plan.
 7. All the activities included in the Scope of Work shall be covered in the work plan.
- l) Bidders shall submit litigation history as per Proforma-IX. If there is no litigation History, the bidder shall specifically mention that there is no litigation History against him as per the clause of litigation history. In case there is litigation history –
Litigation History must cover – Any action of blacklisting, debarring, banning, suspension, deregistration and cheating with MCGM, state govt., Central Govt. or any authority under state or central Govt./ Govt. organization initiated against the company. Firm, directors,

partners or authorized signatory shall be disclosed for last 5 years from the date of submission of bid. Also, bidder must disclose the litigation history for last 5 years from the date of submission of bid about any action like show cause issued, blacklisting, debarring, banning, suspension, deregistration and cheating with MCGM and MCGM is party in the litigation against the company, firm, directors, partners of authorized signatory for carrying out any work for MCGM by any authority of MCGM and the orders passed by the competent authority or by any court where MCGM is a party. While taking decision on litigation history, the concerned chief Engineer of D.M.C. or Director, as may be the case, should consider the details submitted by bidder and take decision based on the gravity of the litigation and the adverse effect of the act of company, firm, directors, partners or authorized signatory on the MCGM works which can spoil the quality, output, delivery of any goods or any work execution and within the timeframe.

Note:

Bidders shall submit the undertaking for equipment capability and other undertaking as such on a single Rs.500/- stamp paper.

- i. The Electrical / Mechanical work shall be got carried out by the civil contractors through the contractors registered with MCGM. in Electrical Category. Information about the registered contractors shall be obtained from the office of the Ch.E. (M&E)/ E.E. (Monitoring & Registration Cell). Attested scanned copy of the valid registration certificate in Electrical Category shall be uploaded with the tender along with the undertaking from the registered Electrical Contractor stating his willingness to carry out the tender work.
- ii. The successful bidder shall submit valid registration certificate under E.S.I.C., Act 1948, if the tenderer has more than 10 employees /persons on his establishment (in case of production by use of energy) and 20 employees/persons on his establishment (in case of production without use of energy) to MCGM as and when demanded. In case of less employees/persons mentioned above then the successful bidder has to submit an undertaking to that effect on Rs. 500 stamp paper as per circular u/no. CA/FRD/I/65 of 30.03.2013.
- iii. The successful bidder shall submit valid registration certificate under E.P.F. & M.P., Act 1952, if tenderer has more than 20 employees/persons on his establishment, to MCGM as and when demanded. In case if the successful bidder has less employees/persons mentioned above then the successful bidder has to submit an undertaking to that effect on Rs. 500 stamp paper as per circular u/no. CA/FRD/I/44 of 04.01.2013.
- iv. The successful bidder shall submit the signed form of the tender, specification of works if any and the schedule of rates.

Note

If it is found that the tenderer has not submitted required curable documents in Packet “B” then, the shortfalls will be communicated to the tenderer through e-mail only and compliance required to be made within a time period of three working days otherwise they will be treated as non-responsive.

PACKET – C

a. Online tender filled in either percentage plus or minus (above or below), or at par. (There is no separate provision to quote % in physical form, this is a part in Header Data of online Tendering). For Packet ‘C’ tenderer(s) will fill data in ‘Item Data Tab’ in Service Line Item via Details and quotes his percentage variation figures. **(If entered ‘0’ it will be treated as ‘at par’.** By default the value is zero only).

Note: In case of rebate/premium of 15% and above as quoted by the tenderer, the rate analysis of major items shall be submitted by L1 and L2 bidder after demand notification by e-mail to bidders. The format for rate analysis is annexed at Annexure E.

Rate analysis in prescribed format shall be submitted online to the engineer in-charge within 3 working days from the date of communication on email, failing which EMD will be forfeited, and the bid will be rejected, and next successful/Responsive bidder will be considered. thereafter, negotiation will be done with the said successive / responsive bidder with respect to his quoted rate.

Applicability of G.S.T. and other sate levies / cess which are not subsumed under GST will be applicable. The bidder shall quote inclusive of all taxes. It is clearly understood that MCGM will not bear any additional liability towards payment of any Taxes & Duties. Wherever, the Services to be provided by the Bidders falls under Reverse Charge Mechanism, the Price quoted shall be exclusive of GST, but inclusive of Taxes / Duties /Cess other than GST, if any. Rates accepted by MCGM shall hold good till completion of work and no additional individual claim shall be admissible on account of fluctuations in market rates; increase in taxes / any other levies / tolls etc. except that payment / recovery for overall market situation shall be made as per price variation. **and if there is any subsequent change (after submission of bid) in rate of GST applicable on the work/services to be executed as per tender, i.e. any increase will be reimbursed by BMC whereas any reduction in the rate of GST shall be passed on to BMC as per the provisions of the GST Act. (Circular No. CA/F/Project/25 dated 12.07.2022)**

- . The Bidder shall furnish, as part of the Bid, Bid Security/EMD, in the amount specified in the Bid Data Sheet. This bid security shall be in favor of the authority mentioned in the Bid Data Sheet and shall be valid till the validity of the bid.
- .The tenderers shall pay the EMD online only instead paying the EMD at any of the CFC centers in MCGM Ward Offices.
- . Any bid not accompanied by an acceptable Bid Security and not secured as indicated in sub-clause mentioned above, shall be rejected by the Employer as non-responsive.
- .The Bid Security of the successful Bidder will be discharged when the Bidder has signed the Agreement and furnished the required Security Deposits.
- . The Bid Security/ EMD of L-3 and bidder shall be refunded immediately after opening of financial bid but, the EMD/ASD submitted by the L-2 bidder will be returned after obtaining Standing Committee Resolution.

The Bid Security may be forfeited:

- a) If the Bidder withdraws the Bid after bid opening (opening of technical qualification part of the bid during the period of Bid validity;
 - b) In the case of a successful Bidder, if the Bidder fails within the specified time limit to:
 - i. sign the Agreement; and/or
 - ii. Furnish the required Security Deposits.
1. The cases wherein if the curable shortfalls are not complied by a contractor, will be informed to Registration and Monitoring Cell. Such non-submission of documents will be considered as 'Intentional Avoidance' and if three or more cases in 12 months are reported, shall be viewed seriously and disciplinary action against the defaulters such as banning/de-registration, etc. shall be taken by the registration cell with due approval of the concerned AMC.
 2. In case of curable/ non curable defects due to non-fulfillment of requirement of MCGM as prescribed & in the event, the bidder becomes non-responsive & the 10%EMD will be forfeited and bid will be rejected. This shall be in addition to any forfeiture of proportionate EMD for curable defects as per other relevant clauses of the tender document, if applicable.

3. In case of non workable rate analysis and misleading information submitted by the bidder, EMD shall be forfeited and bid will be rejected.

~~———— No rejections and forfeiture shall be done in case of curable defects. For non-curable defects the 10% of EMD shall be forfeited and bid will be liable for rejection.~~

Note:

i) Curable Defect shall mean shortfalls in submission such as:

a. Non-submission of following documents,

i. Valid Registration Certificate

ii. Valid Bank Solvency

iii. Sales Tax Registration Certificate (VAT)

iv. Certified Copies of PAN documents and photographs of individuals, owners, etc

v. Partnership Deed and any other documents

vi. Undertakings as mentioned in the tender document.

b. Wrong calculation of Bid Capacity,

c. No proper submission of experience certificates and other documents, etc.

In packet 'A' as well as packet 'B', 02 nos. of shortfall in curable defects will be allowed & 2% EMD will be forfeited for each shortfall thereafter.

ii) Non-curable Defect shall mean

a. In-adequate submission of EMD/ASD amount,

b. In-adequacy of technical and financial capacity with respect to Eligibility criteria as stipulated in the tender.

Note:-

1. In case of non-workable rate analysis and misleading information submitted by the bidder, EMD shall be forfeited and bid will be rejected.

2. In packet 'A' as well a Packet 'B' , 02 nos. of shortfall in curable defects will be allowed & 2% EMD will be forfeited for each shortfall thereafter.

BID VALIDITY

- **Bids shall remain valid for a period of not less than one eighty (180) days after the deadline date for bid submission specified in Bid Data Sheet. A bid valid for a shorter period shall be rejected by the Employer as non-responsive.**
- In exceptional circumstances, prior to expiry of the original time limit, the Employer may request that the bidders may extend the period of validity for a specified additional period. The request and the bidders' responses shall be made in writing or by cable. A bidder may refuse the request without forfeiting his Bid Security. A bidder agreeing to the request will not be required or permitted to modify his bid, but will be required to extend the validity of his bid security for a period of the extension.

DEFECT LIABILITY PERIOD**For this work:-**

1. For general works- 03 years
 2. For structural works – 05 years
- The Contractor is expected to carry out the construction work in Workmen like manner so as to meet the requirement and specification for the project. It is expected that the Workmanship and materials will be reasonably fit for the purpose for which they are required.
 - Defects or defective work is where standard and quality of workmanship and materials as specified in the contract is deficient. Defect is defined as a failure of the completed project to satisfy the express or implied quality or quantity obligations of the construction contract. Defective construction works are as the works which fail short of complying with the express descriptions or requirements of the contract, especially any drawings or specifications with any implied terms and conditions as to its quality, workmanship, durability, aesthetic, performance or design. Defects in construction projects are attributable to various reasons.
 - Some of the defects are structural defects results in cracks or collapse of faulty defective plumbing, inadequate or faulty drainage system, inadequate or faulty ventilation, cooling or heating systems, inadequate fire systems etc. The defects could be various on accounts of different reasons for variety of the projects.
 - The Engineering In charge/Project Officer shall issue the practical completion certificate for the project. During the Defect Liability Period which commences on

completion of the work, the Engineering In charge shall inform or the contractor is expected to be informed of any defective works by the Employer's representative of the defects and make good at contractor's cost with an intention of giving opportunity to the contractor of making good the defects appeared during that period. It is the contractor's obligation under the contract to rectify the defects that appear during Defect Liability Period and the contractor shall within a reasonable time after receipt of such instructions comply with the same at his own cost. The Engineering In charge/Project Officer shall issue a certificate to that effect and completion of making good defects shall be deemed for all the purpose of this contract to have taken place on the day named in such defect liability certificate.

- If defective work or workmanship or design have been knowingly covered-up or concealed so as to constitute fraud, commencement of the Defect Liability Period may be delayed. The decided period may be delayed until **discover** actually occurs on at least the defect could have been discovered with reasonable diligence, whichever is earlier

The DLP shall be as below

Dept	Type of works	DLP	
Roads / Bridge	For cement concrete road/ Mastie works	5 years	
	Asphalt work	3 years	
	Paver Bloek	3 years	
	Structural work	5 years	
	General works	5 years	
BM/SIC/HIC	General works	3 years	
	Structural works	5 years	
	Waterproofing works	5 years	
Ward Works	All ward level works	2 years	
Other Works	Pot holes and pre monsoon bad patch repair work	1 year	
For other departments	WSP, SP, SWD, Garden	3 years	
	HE department	For laying of CI/DI/MS/MDPE water mains upto and including 300 mm dia and allied works as specified	1 year
		For laying of M.S. water mains above 300 mm dia and allied works as specified	3 year

- Also, in case of defect, the Engineer shall give notice to the Contractor of any Defects before the end of the Defects Liability Period, which begins at. The Defect Liability Period shall be extended for as long as Defects remain to be corrected. Every time notice of Defect/Defects is given, the Contractor shall correct the notified Defect/Defects within the duration of time specified by the Engineer's notice. The Engineer may issue notice to the Contractor to carry out removal of defects or deficiencies, if any, noticed in his inspection, or brought to his notice. The Contractor shall remove the defects and deficiencies within the period specified in the notice and submit to the Engineer a compliance report.
- It is the Completion Stage when the contractor has completed all of the works and fixed all of the defects that were on the list of issue by Engineer-in-charge. When this happens, the engineer must issue a 'Certificate of Completion'. On the issue of 'Certificate of Completion', the 'Defect Liability Period' starts. The contractor also must issue a 'Certificate statement' as an acknowledgment to the engineer not later than 14 days after the 'Certificate of Completion' has been issued. During the 'Defect Liability Period', the contractor has to obey all written instructions from the engineer to carryout repairs and fix any defects which appear in the Permanent Works. If the contractor does not ,due to his own faults finish the repair works or fix the defects by the end of 'Defect Liability Period', the 'Defect Liability Period' will continue until all works instructed by engineer is done.
- In case of any lapse in maintenance, the penalties shall be recovered and if necessary the work shall be got done at the risk and cost of the contractor after the prescribed period. The said cost shall be recovered from the Contract Deposit /Retention money or any other deposits, dues with the M.C.G.M. The contractor shall be liable to pay the excess cost if incurred, punitive damages and face penal action in the case of insufficiency of the aforesaid amount.

6.19 SECURITY DEPOSIT AND PERFORMANCE GUARANTEE

A. Security Deposit

The security deposit shall mean and comprise of

- I) Contract Deposit and
- II) Retention Money.

I) Contract Deposit –

The successful tender, here after referred to as the contractor shall pay an amount equal to two (2) percent of the contract sum shall be paid within thirty days from the date of issue of letter of acceptance.

The said contract deposit shall be paid in the form of Demand Draft (D.D) only.

~~The successful tender, here after referred to as the contractor shall pay an amount equal to two (2) percent of the contract sum shall be paid within thirty days from the date of issue of letter of acceptance.~~

II) Retention Money –

The retention money equal to 15.00% of the Contract Sum will be recovered from the contractors every bill i.e. interim / running / final bill. The clause of retention money will not be applicable M. & E. Department.

~~The contractor shall pay the retention money an amount equal to Two (2) percent of the Contract Sum which will be recovered from the contractors every bill i.e. interim / running / final bill. The clause of retention money will not be applicable M. & E. Department.~~

B. Additional Security Deposit

The bidders shall submit the ASD as applicable in the form of Demand Draft, which is to be submitted during office hours minimum one day before opening of packet 'C' to respective Head Clerk (Expenditure) of the Engineer in-charge of the HE Division in sealed envelope. If A.S.D. is not applicable then the bidders shall submit sealed envelope mentioning on their letter head 'ASD is not applicable'.

If the bidders fails to submit the sealed envelope as mentioned above at least one day before opening of Packet 'C' within office hours then the EMD of the respective bidders will be forfeited and the company with their Directors/ Partners and other companies with the said directors / Partner will be further debarred from any tendering process for the period of at least 2 years.

Additional Security Deposit shall be applicable as under:

Rebate quoted by contractor	ASD Applicable
Up to 12% Rebate	No ASD
Rebate above 12.00% on estimated cost	At 2.00% of Estimated cost for each % rebate & part thereof, in D.D only.

~~The additional security deposit will be applicable when a rebate of more than of 12 % at the rate of with no maximum limit. The ASD is calculated as follows:~~

~~Additional security deposit = (X/100) x office estimated cost,~~

~~Where X= percentage rebate quoted above 12%~~

~~The ASD shall be paid online in the ASD tab for bidders in e-tendering system before submission of the bid.~~

C. Performance Guarantee

The successful tender, here after referred to as the contractor shall pay in the form of “Performance Guarantee” at different rates for different slabs as stated below:

Offer	PG applicable %
For premium, at par and rebate 0 to 12%	PG= 0.92% x contract sum applicable for rebate of 12%
For rebate of 12.01%	P.G. = {0.92% x contract sum applicable for rebate of 12%} +(X) x contract sum where X= percentage rebate quoted more than 12%

Note: Contract sum shall mean amount after application of rebate/premium as quoted by the contractor with contingencies only and excluding price variation.

The PG shall be paid in one the following forms.

- I) Cash (In case guarantee amount is less than Rs.10,000/-
- II) Demand Draft (In case guarantee amount is less than Rs.1,00,000/-)
- III) Government securities
- IV) Fixed Deposit Receipts (FDR) of a Schedule Bank.

- V) An electronically issued irrevocable bank guarantee bond of any Schedule bank or f in the prescribed form given in Annexure.

Performance Guarantee is applicable over and above the clause of Security Deposit. Performance Guarantee will have to be paid & shall be valid till the defect liability period or finalization of final bill whichever is later.

This deposit will be allowed in the form of I to V as mentioned above and shall be paid within 15 days after receipt of Letter of Acceptance.

Note: Following exceptions shall be adopted for ‘Demolition Tenders’:

- i. Irrespective of the offer (Rebate/ at par/ premium), ASD shall be differed and only PG of 10% of contract sum be taken from the successful bidder on award of contract only.
- ii. MCGM departments shall ensure to incorporate specific condition regarding above in bid document and e-tender notice.

D. Refund of Security Deposit

I. Refund of Contract Deposit (As per applicable circular)

The Contract Deposit shall be released within 30 days after completion of 3rd year of DLP (in case of 5 years DLP) and after issue of ‘Defect Liability Certificate’ (in case of 1 or 2 or 3 years DLP) subject to no recoveries are pending against the said work, provided that the Engineer is satisfied that there is no demand outstanding against the Contractor. No claim shall be made against the Balance Contract Deposit after the issue of Defects Liability Certificate.

II. Refund of Retention Money (As per applicable circular)

The Retention Money will be refunded after completion of defect liability period and after issue of “Defect Liability Certificate” (in case of 1 or 3 or 5 years DLP) provided that the Engineer is satisfied that there is no demand outstanding against the Contractor. In the event of different Defects Liability Periods have been specified or become applicable to different sections or parts of the Permanent Works, the said money will be released within 30 days on expiration of such Defects Liability Periods. In the event the Engineer issues a Taking-over Certificate for a section or part of the Permanent Works, only such proposition thereof as the Engineer determines (having regard to the relative value of such section or part of the Works) shall be considered by the Engineer for payment to the Contractor.

~~One half (50%) of the Retention Money shall be released within 30 days of issue of ‘Certificate of Completion’ with respect to the whole of the Works. In the event the~~

~~Engineer issues a Taking over Certificate for a section or part of the Permanent Works, only such proposition thereof as the Engineer determines (having regard to the relative value of such section or part of the Works) shall be considered by the Engineer for payment to the Contractor.~~

~~The balance Retention Money shall be released within 30 days after completion of 3rd year of DLP (in case of 5 years DLP) and after issue of 'Defect Liability Certificate' (in case of 1 or 2 or 3 years DLP) provided that the Engineer is satisfied that there is no demand outstanding against the Contractor. In the event of different Defects Liability Periods have been specified or become applicable to different sections or parts of the Permanent Works, the said moneys will be released above mentioned 50% is exclusive of the amounts to be withheld as stated in and that amount shall be paid within 30 days on expiration of the latest of such Defects Liability Periods. Payment of the as per condition stated therein.~~

III. Refund of Additional Security Deposit (As per applicable circular)

One-half (50%) of the additional security deposited (ASD) shall be released after the completion of 50% financial progress of the work.

The balance ASD shall be released within 30 days of issue of 'Certificate of Completion' with respect to the whole of the work. In the event the Engineer issues a Taking-over Certificate for a section or part of the Permanent Works, only such proposition thereof as the Engineer determines (having regard to the relative value of such section or part of the Works) shall be considered by the Engineer for Refund of ASD to the contractor.

~~1. The additional security deposit shall be released within 30 days of issue of 'Certificate of Completion' with respect to the whole of the Works. In the event the Engineer issues a Taking over Certificate for a section or part of the Permanent Works, only such proposition thereof as the Engineer determines (having regard to the relative value of such section or part of the Works) shall be considered by the Engineer for payment to the Contractor.~~

~~2. Additional Security Deposit shall only be refunded after submission of whole records related to the tender works.~~

IV. Refund of Performance Guarantee (As per applicable circular)

The Deposit on account of performance guarantee shall be released within 30 days of completion of Defects Liability Certificate subject finalization of final bill whichever is

later and no recoveries are pending against the said work, provided that the Engineer is satisfied that there is no demand outstanding against the Contractor.

❖ ~~Summary of time of Refund of deposit is tabulated as follows:~~

~~a) Time of Refund for works having 5 years DLP~~

Deposits refunded after completion	After 3 yrs of DLP	After Completion of DLP
ASD + 50% of RM	CD+50% of RM	PG

~~b) Time of Refund for works having 1 or 2 or 3 years DLP~~

Deposits refunded after completion	After Completion of DLP
ASD + 50% of RM	CD+50% of RM+PG

*Note:

a) It shall be clearly mentioned that the BG shall be applicable for individual work/contract and clubbing of various contracts of the said contractor will not be allowed. In case of obtaining Bank Guarantee, it is necessary to mention that the same shall be valid further 6 months from the completion of defect liability period/ warranty period.

b) It shall be the responsibility of the bidder to keep the submitted B.G. "VALID" for the stipulated time period in the tender & in case of its expiry it will attract penalization.

c) Bank Guarantee should be issued by way of General Undertaking and Guarantee issued on behalf of the Contractor by any of the Nationalized or Scheduled banks or branches of foreign banks operating under Reserve Bank of India regulations located in Mumbai upto Virar & Kalyan. List of approved Banks is appended at the end of Instructions to Bidders (ITB). The Bank Guarantee issued by branches of approved Banks beyond Kalyan and Virar can be accepted only if the said Bank Guarantee is countersigned by the Manager of a Regional Branch of the same bank within the Mumbai City Limit categorically endorsing thereon that the said Bank Guarantee is binding on the endorsing Branch of the Bank or the Bank itself within Mumbai Limits and is liable to be enforced against the said Branch of the Bank or the bank itself in case of default by the Contractors furnishing the Bank Guarantee. The Bank Guarantee shall be renewed as and when

required and/or directed from time to time until the Contractor has executed and completed the works and remedied any defects therein.

E. Legal + Stationary Charges: (As per applicable circular)

Successful tender shall pay the Legal Charges +Stationary charges as per Circular No 10318 dtd.24/03/2022

Contract Value						Legal+ Stationery Charges
Upto	Rs.	10001/-	To	Rs.	50,000/-	Nil
From	Rs.	50,001/-	To	Rs.	1,00,000/-	Rs. 6,290/-
From	Rs.	1,00,001/-	To	Rs.	3,00,000/-	Rs. 10,380/-
From	Rs.	3,00,001/-	To	Rs.	5,00,000/-	Rs. 12,470/-
From	Rs.	5,00,001/-	To	Rs.	10,00,000/-	Rs. 14,510/-
From	Rs.	10,00,001/-	To	Rs.	20,00,000/-	Rs. 16,570/-
From	Rs.	20,00,001/-	To	Rs.	40,00,000/-	Rs. 18,660/-
From	Rs.	40,00,001/-	To	Rs.	1,00,00,000/-	Rs. 20,720/-
From	Rs.	1,00,00,001/-	To	Rs.	10,00,00,000/-	Rs. 24,450/-
From	Rs.	10,00,00,000/-	To	Rs.	20,00,00,000/-	Rs. 28,220/-
From	Rs.	20,00,00,000/-	To	Rs.	30,00,00,000/-	Rs. 31,980/-
From	Rs.	30,00,00,000/-	To	Rs.	40,00,00,000/-	Rs. 35,740/-
From	Rs.	40,00,00,000/-	To	Rs.	50,00,00,000/-	Rs. 39,470/-
From	Rs.	50,00,00,000/-	To	Rs.	1,00,00,00,000/-	Rs. 47,000/-
From	Rs.	1,00,00,00,000/-	To	Rs.	2,00,00,00,000/-	Rs. 58,270/-
From	Rs.	2,00,00,00,000/-	To	Rs.	3,00,00,00,000/-	Rs. 65,770/-
From	Rs.	3,00,00,00,000/-	To	Rs.	4,00,00,00,000/-	Rs. 75,120/-
From	Rs.	4,00,00,00,000/-	To	Rs.	5,00,00,00,000/-	Rs. 84,510/-
From	Rs.	5,00,00,00,000/-	To	Rs.	Onward	Rs. 93,920/-

The tenderers are requested to note that stationary charges as given in the table above will be recovered from the successful tenderer for supply of requisite prescribed forms for preparing certificate bills in respect of the work.

B. Stamp Duty: (As per applicable circular)

It shall be incumbent on the successful tenderer to pay stamp duty on the contract.

- i. As per the provision made in Article 63, Schedule I of Bombay Stamp Act 1958, stamp duty is payable for “works contract” that is to say, a contract for works and labour or services involving transfer of property in goods (whether as goods or in some other form) in its execution and includes a sub-contract, as under :

(a)	Where the amount or value set forth in such contract does not exceed rupees ten lakh.	Five Hundred rupees stamp duty
(b)	Where it exceeds rupees ten lakhs	Five hundred rupees plus one hundred rupees for every Rs.1,00,000/- or part thereof, above rupees ten lakh subject to the maximum of rupees five lakh stamp duty.
c)	Bank guarantee : As per article 54 read with 40(b) of stamp duty act, stamp duty of 0.5% will be applicable to all bank guarantee submitted also which are required to be renewed after expiry of time period	0.5%

- ii. The successful bidder shall enter into a contract agreement with the M.C.G.M within 30 days from the date of issue of work order and the same should be adjudicated for payment of stamp duty by the successful bidder.
- iii. Further shortfall if any, in amount of stamp duty paid as against prescribed amount for the documents executed in Mumbai City & Mumbai Suburban District be recovered from the concerned work contractors and to deposit the deficit or unpaid Stamp Duty and penalty by two separate Demand Draft or Pay Order in favour of “Superintendent of Stamp, Mumbai” within 15 days from intimation thereof.
- iv. All legal charges and incidental expenses in this respect shall be borne and paid by the successful tenderer.

6.20 IMPORTANT DIRECTIONS

1. All the information uploaded shall be supported by the corroborative documents in absence of which the information uploaded will be considered as baseless and not accepted for qua-

lification criteria. All the documents shall be uploaded with proper pagination. The page No. shall be properly mentioned in the relevant places.

The information shall be uploaded in the sequence as asked for with proper indexing etc. The Bidder shall be fully responsible for the correctness of the information uploaded by him.

2. Applicants/Bidders shall refer portal.mcgm.gov.in/tenders for “The Manual of Bid-Submission for Percentage Rate/Item Rate Tender Document.” The detail guidelines for creation and submission of bid are available in the referred document.

Any queries or request for additional information concerning this TENDER shall be submitted by e-mail to cewwcivilmaintes.he@mcgm.gov.in / , The subject shall clearly bear the following identification/ title: "Queries/ Request for **Additional Information: TENDER for “.**"

- Any changes in mail ID will be intimated on the portal.

3. In case of **Equal Percentage** of lowest bidders (L1), the allotment of work shall be done by giving 48 hrs (**2 working days**) from the day of opening of packet C **on same BID-Document number for re-quoting** and such development needs to be done by IT department in MCGM's SRM system. **Till such development is made; ‘Sealed Bids’ shall be called from the bidders quoting the same rates i.e. L1.**

In case of equal percentage of lowest bidders is obtained even after re-quoting, then the successful bidder will be decided by lottery system by concerned Ch. Eng.

The bidder shall need to submit the additional ASD if applicable within 7 days after receipt of notification issued by concerned Chief Engineer.

Also, the Performance Guarantee shall be paid in 15 days after receipt of Letter of Acceptance.

6.21 GENERAL DIRECTIONS TO TENDERERS:

1. Firms with common proprietor / partner are connected with one another either financially or as master and servant or with proprietor / partner closely related to each other such as husband, wife, father / mother and minor son / daughter and brother / sister and minor brother / sister, shall not tender separately under different name for the same contract.
2. If it is found that firms as described in clause 6.21.1 have tendered separately under different names for the same contract all such tenders shall stand rejected and tender deposit of each such firm / establishments shall be forfeited. In addition, such firms / establishments shall be liable, at the discretion of the Municipal Commissioner, for further penal action including blacklisting.

3. If it is found that closely related persons as in clause 6.21.1 have submitted separate tenders under different names of firms, establishment but with common address for such establishment / firms and / or if such establishment firms though they have different address, are managed or governed by the same person / persons jointly or severally such tender shall be liable for action as in clause 6.21.2 including similar action against firms / establishment concerned.
4. If after award of contract, it is found that the accepted tenderer violates any of the clauses, 6.21.1, 6.21.2, 6.21.3 the contract shall be liable for cancellation at any time during its currency in addition to penal action against the contractors as well as related firms / establishments.
5. Tenderers should note in addition to the official address, they should furnish private residential address, mobile nos., email ids of the partners. Any fault in this respect may justify the rejection of Tender.
6. In the event of tender being accepted, full amounts of contract deposit must be paid and contract must be signed by all the partners of the firm and if one or more partners be not available for the purpose, signatory must produce a Power of Attorney must be registered in the office of C.A (Finance) / C.A (Treasury) /C.A (WSSD).
7. In the case of a Joint Stock Company, the contract must be sealed with the seal of the company in the presence of and signed by the two Directors or by a person duly authorized to sign the contract for the Company by a power of attorney, such power being sealed and signed as aforesaid. All such power of attorney must be registered in the Municipal Office.
 - a) Tenderers must distinctly understand: That they will be strictly required to conform to the conditions of this contract as contained in each of its clauses and that the plea of "custom prevailing" will not on any account be admitted as an excuse on their part for infringement of any of the conditions.
 - b) That no alternation or interpolation will be allowed to be made in any of the terms and conditions of this contract or in the Specification of in the Schedule, and that if any such alteration or interpolation be made by a Tenderer, his tender will, at the option of the Municipal Commissioner, either be rejected or to be treated as if no such alteration or interpolation has been made.
 - c) That the full contract deposit must be paid within the time specified and the contract must be executed within the stipulated time frame by the successful tenderer.

- d) That a postponement of the payment of the full contract deposit or the execution of the contract will not be permitted by reason of the Corporation having in possession other deposits on account of other tenders or contracts, which deposit may be or become returnable to the tenderers and which they may wish to transfer as a deposit under this contract. Such transfers will not under any circumstances be permitted.
- e) **Tenderers shall note that if the conditions of G.C.C. are in variance with the conditions contained in the tender document the conditions of the tender document shall prevail.**

6.22 SITE INSPECTION

Prior to submitting and uploading e-tender for the work the tenderer should visit and examine at the site of works and its surroundings at his own expense and obtain and ascertain for himself, on his own responsibility & risk all information, technical data etc. that may be necessary for preparing his bid and entering into a contract including, inter-alia, the actual conditions regarding the nature and conditions of site, availability of materials, labour, probable sites for Chowky/stores etc. and the extent of lead and lift required for the execution of the work over the entire duration of the contract, after taking into consideration local conditions, traffic restrictions, obstructions in work, if any allow all such extra expenses that are likely to be incurred due to any such conditions, restrictions, obstructions etc. in the quoted contract price for the work.

They shall obtain further clarification, if any, on any specific issue from the Deputy Hydraulic Engineer (Maintenance) / E.E. (Maintenance) Meter Workshop, the offices of whom are situated at Executive Engineer (Maintenance) Meter Workshop , 566, N.M.Joshi Marg , Near S. Bridge , Byculla (West), Mumbai-11 before submitting the tender. Tenderers/Contractors should note and study the condition related to site constraints and its impact.

6.23 MODIFICATIONS IN TENDER DOCUMENT

If M.C.G.M considers it is necessary to carry out any modifications, in the tender documents and extend the closing date of the tender the same shall be made by an addendum. Copy of addendum will be uploaded on M.C.G.M.'s portal. Each addendum shall be signed by the tenderer(s) and scanned copy of the same should be uploaded in Packet 'B'. The tenderer(s) shall not add or amend the text of any documents contained in tender document.

6.24 TAXES AND DUTIES ON MATERIAL

~~All taxes, duties, cess and charges such as Octroi, Service Tax, Terminal or Sales Tax etc. and other duties on material obtained for the work from any source including the tax~~

~~applicable as per Maharashtra Sales Tax Act, on the transfer of property in goods involved in the execution of work contracts (re-enacted) Act 1989, Maharashtra State Building & Other Construction Workers Welfare Cess (G.R.No BCA 2009 / C.N/108/ /Labour7 A dated 17.06.10) shall be borne by the tenderer. The tenderer shall not be reimbursed the taxes, duties, cess and charges whether now in force or that may be brought in force. tenderer should submit necessary octroi receipts to the dept. in respect of material brought by him from supplier outside Mumbai limit.~~

~~Whenever required the tenderer will have to produce a certificate from the Chief Accountant of this Corporation to the effect that the tenderer is not in arrears against his personal account.~~

~~“All charges on account of all Custom Duties, Import Duties, Excise Duties, Business, Income Taxes, Octroi Terminal/VAT/Turnover and other taxes etc. on material, equipment supplies to be used or services to be performed under the contract obtained for the work from any sources as amended up to date shall be borne by the contractor, as per the General Condition of Contract under Taxation Clause and Tender Conditions.—~~

~~However, as per the prevailing tax policies of State/Central Government if M.C.G.M. is eligible for getting exemption from excise and other duties or any other taxes payable on any of the material, equipment supplies to be procured or services to be performed for execution of the tender work, then M.C.G.M. will issue work specific Exemption Certificate to the concerned authority for availing the same. Exemption Certificate issued, shall not be misused. If found misused anywhere, then action as deemed fit including blacklisting of the contractor from M.C.G.M. will be taken.~~

~~—The tenderer should also note that the execution of work should not be delayed for want of exemption certificate. Any taxes and duties paid until issue of exemption certificate will not be reimbursed. The tenderer should note this and quote accordingly.”~~

~~Tenderer shall be registered under the Maharashtra Sales Tax on the transfer of property in goods involved in the execution of works contracts (Re-enacted) Act 1989 and should produce documentary evidence of the effect (a copy of registration of certificate from the sales tax department) along with the tender.~~

~~G.S.T. and other state levies/cess which are not subsumed under GST will be applicable. The tenderer shall quote inclusive of all taxes. It is clearly understood that MCGM will not bear any additional liability towards payment of any Taxes and Duties.~~

~~Wherever the services to be provided by the tenderer fall under Reverse Charges Mechanism, the price quoted shall be exclusive of GST, but inclusive of Taxes/Duties/Cess other than GST, if any.~~

Rates accepted by MCGM shall hold good till completion of work and no additional individual claim shall be admissible on account of fluctuation in market rates: increase in taxes/any other levies/toll etc. except that payment/ recovery for overall market situation shall be made as per price variation.

6.24.a “ As per circular CA/Finance/Proj/City/17, dated 06.09.2017”Chapter XXI-Miscellaneous ,section 171(1) of GST Act-2017 governs the ‘Anti Profiting Measure’(AMP). As per the provision of this section, ‘Any reduction in rate of tax on any supply of goods or services or the benefit of input tax credit shall be passed on to the recipient by way of commensurate reduction in prices.’

Accordingly, the contractor should pass on the complete benefit accruing to him on account of reduced tax rate or additional input tax credit , to MCGM.
Further, all the provision of GST Act will be applicable to the tenderer.

6.25 SOLVENCY CERTIFICATE

Tenderer(s) shall upload a scanned copy of latest solvency certificate for required amount from a bank of M.C.G.M approved list attached issued *maximum 12 (twelve) months prior to due date of tender*. Latest solvency certificate shall be submitted in physical format if the tender is awarded to bidder.

6.27 ERRORS AND DISCREPANCIES IN TENDER

If tender contains errors in the Bill of Quantities such as computing mistakes, incorrect transfer etc. the Engineer will inform the tenderer(s) of such errors or discrepancies and rectify the errors or discrepancies and will re-total the amounts of Bill of Quantities. The foregoing procedure may be applied at any time prior to award of contract and the Engineer is not liable for any error or discrepancy which was not discovered during scrutiny of the tender.

6.28 EVALUATION OF TENDER

In comparing tenders, the corporation shall consider such factors as the efficiency and reliability of instrument and methods proposed, compliance with the specifications, quality and the tenderer’s capacity to perform vis-à-vis the time of completion.

6.29 AWARD OF CONTRACT

Notification of award by way of work order prior to the tender validity period will be issued in writing to successful tenderer. The contract will be awarded to the best responsive tenderer(s) offering the lowest evaluated tender in conformity with the tender document. Corporation reserves right to accept/reject any or all tenders and to annul the tendering

process at any time prior to award of contract.

Prior to the expiry of the Tender validity, the Corporation will notify the successful tenderer(s) by a letter that his tender has been accepted, if required. This letter herein after and in condition of contract called “The Letter of the Acceptance”. Notification of Award will constitute the information of contract.

6.30 DISPUTE

In case of any claim, dispute or difference arising in respect of the contract such claim, dispute or difference shall be dealt with as per **G.C.C clause no. 73, as amended up to date.**

6.31 Contract Labour (Regulation and Abolition Act 1970):

The tenderer(s) should specifically note that the successful tenderer shall have to strictly comply with the entire statutory requirement under the provision of the Contract Labour (Regulation and Abolition) Rules 1970 and with the Maharashtra State Contract Labour (Regulation and Abolition) Rules 1971 and indemnify the Corporation against any claim(s) whatsoever.

6.32 As per the Contract Labour (Regulation & Abolition) Act 1970, every contractor should obtain a license certificate from the office of Labour Commissioner situated at Commerce Center, Tardeo, near A.C market, Mumbai – 400 034.

6.33 An amount of 1% of the contract cost shall be deposited with the government of Maharashtra as per circular u/no BCA/2007/CN/788/Kamgar 7A dated 16.10.2009.

6.34 The tenderer shall submit the copy of Registration issued under Employees provident fund and Miscellaneous Provisions Act 1952.

6.35 The tenderer shall also submit the copy of registration certificate issued under Employees State Insurance Corporation (E.S.I.C Act 1948).

6.36 Tenderers are requested to take cognizance of Child Labour Act and take precaution not to employ Child Labour on site. ***If Child Labour is found to be employed on the work, a penalty of Rs 5000/- on the spot will be imposed on the defaulting contractors and further action as deemed fit will be taken.***

6.37 The contract period shall be as mentioned in the tender notice. The period required for mobilization, procurement of material, traffic permission, other required permissions, erection of site office etc. complete shall be reckoned from the date of issue of work order.

6.38 ~~The project works, Renewal of service connections and laying of water main work shall not be~~

carried out during the monsoon period without prior sanction from competent authority.

6.39 The rates for unforeseen fair and extra items for the works, which are available in the Unified Schedule of Rates of M.C.G.M, applicable to the tender, will be paid as per G.C.C. in force as amended upto date by M.C.G.M.

6.40 The tender shall have to start & simultaneously carry out the works included in the tender at multiple locations or as directed by the engineer.

6.41 *As per circular no. CA/FDT/1488/of 17.01.2012 no amendments in the original scope of work will be made without specific prior approval of concerned A.M.C /M.C. No permission will be granted in any circumstances, to execute any additional work in another ward, by using the savings in BOQ, without sanction of competent authority. Tenderer should strictly note this clause.*

6.42 The proposes subject tender work ,the water mains shall be laid by diverting, re-aligning, and supporting etc any/all existing utilities as directed and in consultation with respective authorities such as B.E.S.T, Traffic Police, M.T.N.L, B.S.E.S,M.S.E.B, Tata Electric Co, Tata Power, Mahanagar Gas, Railway Authority, Forest Authority, Salt Dept., P.W.D, MBPT, Tata Power, M.M.R.D.A, M.S.R.D.C etc. All precautionary/preventive and safety measures shall be taken to avoid any mishaps/accidents with utilities, labours and public. Any damage to utilities and consequences thereof shall be made good by the tenderer at his own risk and cost as directed by the authority/M.C.G.M.

6.43 The subject tender water work is proposed on most busy road in Mumbai. There will be remote chances to get full closure of road. Intending tenderers have to carry out the work in phase wise manner by allowing moving heavy vehicular traffic nearby and abutting to existing concrete road, Bridge foundation & substructure, infrastructure of existing utility and infrastructure if any and safeguarding of the same shall be entirely tenderer's responsibility. All precautionary/preventive and safety measures shall be taken to avoid any caving underneath the pavement, side collapse & mishaps/accidents thereof. No extra claim will be entertained on this account. Any damage & consequences thereof shall be made good by the tenderer at his own risk and cost as directed by the authority/M.C.G.M.

6.44 The tenderer should note that he has to provide adequate barricading, during the various activities concern with the completion of the work in all respect in view of the above mention site conditions while carrying out the work as per the design and drawing of the MCGM.

6.45 BARRICADING

- i. The tenderer should note that he has to provide adequate barricading, during the various activities concern with the completion of the work in all respect in view of the above

mention site conditions while carrying out the work as per the design and drawing of the MCGM.

- ii. It shall be distinctly noted that MCGM will not made any payment towards item of providing barricaded of any and all kinds as directed. The contractors shall take this fact into consideration while quoting.
- iii. It will be entirely responsibility of the contractor to provide and install secure barricades on work site, wholly at his cost.
- iv. The barricading shall be provided as per specifications and drawing given below.
- v. The cardinal principal behind installing secure and continuous barricading is to ensure the safety of the road users/residents of vicinity etc. Due to non installation of barricades or due to inadequate installation of barricades on sites, if any accident occurs on site leading to injury or loss of life, then the contractor and contractors engineer will be liable for consequent action.
- vi. If it is noticed during course of execution that proper barricading is not provided by the contractor then a penalty of Rs.2000/- per meter per day will be imposed. Penalty on account of lapses in providing barricades will be cumulatively imposed to the tune of 5% of the contract cost.
- vii. ~~The details of the work shall be prominently displayed in central panel of the barricades in following format.~~

Name of work _____

Contract cost _____

Date of starting _____

Time period _____

Contractors engineer _____

Mobile Number _____

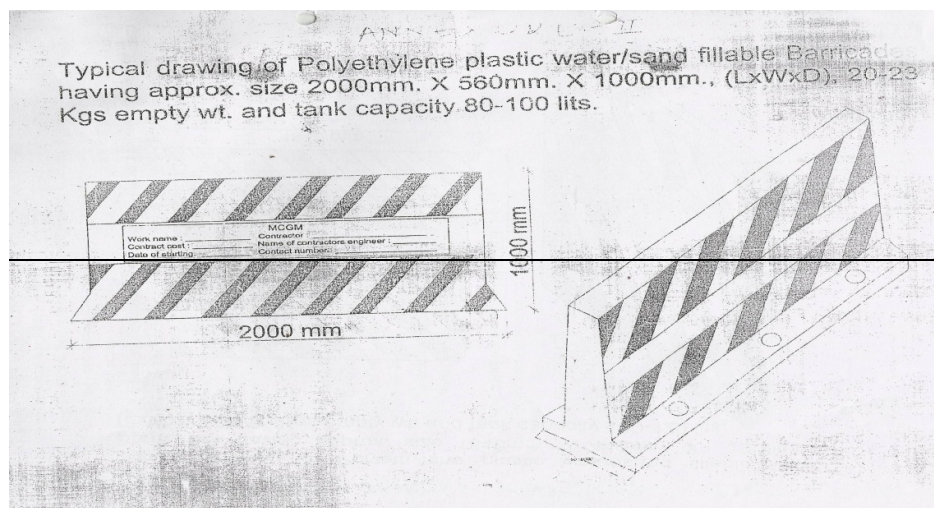
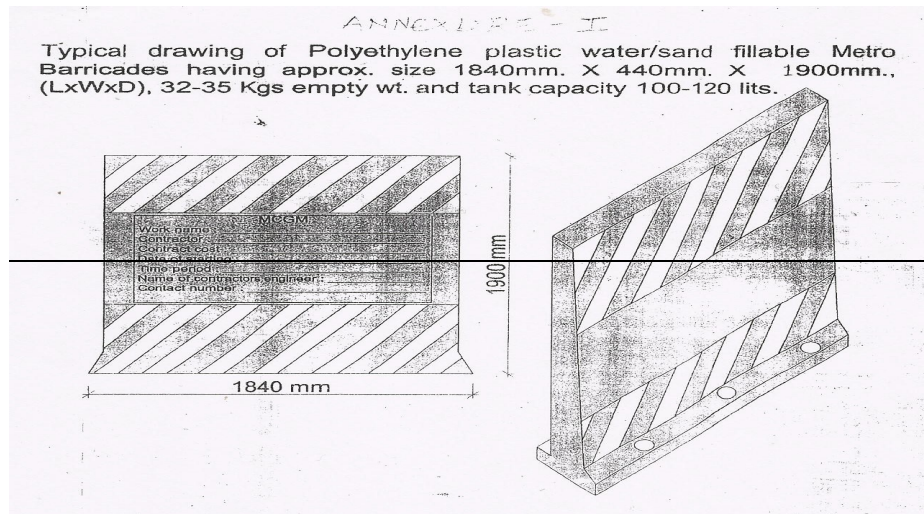

OR

Providing and fixing the barricading in double row with G.I. Sheets of 22 gauge manufactured by TATA Co. and JINDAL Co. fixed on 3 inch dia.(75mm.) wooden bullies which will be buried in existing road sufficiently. Embossing of TATA/JINDAL Brand on G.I. Sheet shall be ensured before painting with yellow and black bands of Synthetic enamel paint as per the traffic norms and as directed by the Engineer.

OR

Providing and fabricating the steel barricade of size 1.8m x 1.5 M made out of 1.25 mm. the MS plates of size 1.8 M x 1.0 M , M. S. Angles ISA 40mm x40mmx5mm., MS flat 40mm x5mm thk of, Lloyd Steel, SAIL, Essar Steel approved in straight profile of all sizes, shapes and for all works including stiffeners, bolts and nuts, fillet/butt welding, splicing, machine grinding of all member joints wherever required to give neat appearance, fabricating to a curved or bent profile like arch or semi circular shape, fixing at site as directed etc. complete." These barricading are reusable for 50 times & shall be neatly painted while providing on site.

~~Barricading for major trenches having depth more than 2 mtr~~

~~“Providing and fabricating the structural steel barricade made out of 1.25 mm. thk MS plates of size 2.5 M x 2M , M. S. Angles ISA 40mm x40mmx5mm., MS flat 40mm x5mm thk and ISLB 250 mm x 125 mm as per IS 1161 - I RHS/SHS rolled angle plates etc. (material as per IS 4923 Grade YST 241) of TATA Steel, Lloyd Steel, SAIL, Essar Steel approved in straight profile of all sizes, shapes and for all works including stiffeners, bolts and nuts, fillet/butt welding, splicing, machine grinding of all member joints wherever required to give neat appearance, fabricating to a curved or bent profile like arch or semi circular shape, fixing at site as directed etc. complete. Rate is including the entire logistics of transporting and other related activities for completing this item.”~~

Note:- Bidder shall note that any one of above barricading will have to provide as per site condition for excavated trenches. No payment shall be made for barricading. For revised guidelines regarding barricading use circular u/no.MGC/F/6342 Dated.5/05/2018.(Circular is attached on Pg 264-270).

6.46 Quantities of all items provided in the BOQ may not be required to be executed depending upon the site conditions. The tenderer shall not be entitled for any compensation on this account. Before starting the work, tenderer shall consult with the site in charge and shall take actual measurements on the site for procurement of material.

6.47 The tenderer should note that while executing the jobs allotted to them, the payment will be made as per the items included in the BOQ & as per the relevant items included in the various unified schedules of Rates of the M.C.G.M effective at the time of work and if any item or activity doesn't cover in the BOQ, the payment will be made as per the G.C.C or as amended from time to time by M.C.G.M.

6.48 The Tenderer shall procure necessary material required for the work with ISI mark wherever applicable from the manufacturer(s), with ISI certificates and or according to M.C.G.M specifications.

6.49 All material required for the work can be stacked near *the* site of work in such a manner so as not to cause any inconvenience to the pedestrian and vehicular traffic. If no space is available on site then tenderer shall make his own arrangement for stacking of material etc. No extra payment will be made on this account.

The tenderers shall have to make their own provisions for site office / labourers huts / site

godown either on his / her own place or rented / leased place. No permission shall be granted vide circular u/no ChE/487/Rds(Tr&Br)/SR dated 18.09.2012 for erecting site office / labourers huts / site godowns on road carriageway / footpath.

6.50 The tenderer shall obtain traffic permission from Traffic Police Department. For erection of site office, cement godown, store etc wherever required. The tenderer shall obtain necessary permission from concerned competent authority on payment of necessary charges as demanded by the concerned authorities as per the prevailing rules. The cement godown, watchman's cabin etc. shall be provided as directed and shall be removed by the Tenderer on completion of the work at their cost wherever required. It is also binding on Tenderer to fulfill requirements of environmental authorities. The work shall be started only after construction of site office, cement godown, store etc. (after completing all formalities) and after getting necessary traffic. Permission, road opening permission if applicable etc. The work is required to be executed at one / more places and hence the contractor will be directed by the engineer to start the work at more than one place. BAR / C.P.M / P.E.R.T / Milestone chart shall be submitted considering all these factors.

6.51 The tenderers should simultaneously work at one / multiple places as directed by Engineer to complete the work within contract period.

6.52 Tenderers shall obtain permission from traffic police department and shall provide various boards and proper barricading of trenches wherever necessary on site to have smooth traffic as per the requirement of traffic police department and shall have proper coordination with competent concerned authority/ward staff, A.E.W.W and A.E.W.W (Maint.) etc. If required & insisted by traffic police department traffic warden shall be appointed on site.

6.53 Tenderer shall have to obtain all the permissions of the concerned authorities required for carrying out the work. Only recommendatory letters will be issued by the M.C.G.M.

6.54 Within one month of completion of work, the tenderer shall submit at his cost seven copies of Ammonia prints of completion drawings of laying work if any along with soft copy showing all the details checked and duly signed by Engineer & tenderer. The payment of final bill shall be made to the appointed Contractors after receipt of above sets failing which necessary action as per G.C.C / circulars in force on the date of work order till the entire contract period will be initiated.

6.55 Item of cutting C.I. pipe is also applicable for Ductile Iron Pipe and no fair rate will be admissible.

6.56 The contractors should provide suitably required number of M.S plates on trenches of suitable thickness and size for smooth movement of vehicular traffic as per the requirement of

traffic department. Contractor should note that no payment will be made to the contractor for providing, removing and refixing M.S plates on trench etc.

- 6.57** While excavation of trenches, temporary arrangement like placing of M.S plate over/ trenches in front of the entrances of the properties shall be done to allow vehicles/ public entries to the properties. No extra payment will be made for this.
- 6.58** All mild steel specials required for execution of work shall be fabricated from pipes on site. No extra cost will be paid for fabrication of M.S. specials except payment for welding and cutting under respective item of bill of quantities. Also payment for laying of M.S specials in trenches will be made with average length for bends (mean of internal outer length). In case of valve chambers, the required M.S cover plates& M.S sections will be considered for payment on weight basis & it is inclusive of cutting, welding, fabrication, etc, required to complete the work.
- 6.59** Contractors should note that the work of laying of water main and work of cross connections shall be done simultaneously within the time period. As soon as laying work is started main cross connection shall be carried out and water main shall be flushed as directed.
- 6.60** Tenderer should note that the supply of material, supply of C.I. specials, M.S specials if included in the Bill of Quantities shall be made available anywhere in the city or suburbs or at the departmental work chowkies as directed. The rates of these supply items include transport, loading, unloading etc. complete.
- 6.61** Tenderer shall be registered under the GST Act 2017 and should produce documentary evidence to the effect (a copy of registration of certificate from the GST department along with the tender).
- 6.62** Tenderer shall note that H.E's schedule item for Butterfly valve is inclusive of providing and fixing adopter. No extra payment will be made on this account.
- 6.63** The contractor will be directed by the Engineer to execute the additional emergency work of excavation, laying of water mains, cross connections, construction of S.V. Chambers, concrete blocks, digging trial pits & other related works to H.E. Dept. etc. to any extent. The quantum of the work of any item may get reduced or increased to any extent. However, the payment of the work shall be made as per terms and conditions of contract.
- 6.64** Wherever mechanical joints will be used on the water main it will be necessary to fill the gap between the outer edge of the pipe and special / collar/socket with spun yarn as usual.

The costs of fixing mechanical joints are inclusive of said work. No extra amount will be paid on this account.

- 6.65** The sluice valves, B.F. valves, air valves, fire hydrants etc. to be provided on proposed water main shall be as per relevant I.S/M.C.G.M specifications and shall be got tested in Municipal Workshop or as directed by the Engineer.
- 6.66** In case the controlled concrete to be provided at one place/or on particular day, is of small quantity i.e. less than 10 Cu.m, M10 may be considered as equivalent to 1:3:6, M15 as 1:2:4, M20 as 1:1.5:3. The concrete sample/ cubes for M10, M15, M20 shall be tested for every 100 Cu.m quantity irrespective of individual quantity is less than 10Cu.m.
- 6.67** The contractors shall bring the correct size of metal/material required for construction of water bound layers. The contractors will not be allowed to break stones for preparation of material for water bound layers on site.
- 6.68** The rate of supplying, loading, transporting on site, unloading and lowering in trenches of all kinds of pipes up to 450 mm dia is inclusive of cleaning, flushing and testing of water mains up to 10 kg /cm² pressure as directed by the engineer.
- 6.69** Latest circulars / guidelines should be followed for providing fencing, barricading & lighting.
- 6.70** Please refer circular No. HE/Cir/13 dated 25.10.05 for specification of M.S, D.I& P.E pipes or amended till date.
- 6.71** All the sluice valves to be provided shall be GLANDLESS VALVE & preferably with clock wise opening. False Key (i.e. Chavi) required to operate Butterfly valve should be provided with vertical pipe rod and handle as directed by the Engineer. No additional payment for the same will be paid to the tenderer.
- 6.72** The M.S. Pipes shall be manufactured from plates conforming to IS 2062- FE -410. The M.S. pipes shall be fabricated as per IS 3589 (i.e. the fabricated company shall have ISI certificate for fabrication of respective dia. of MS pipes). Spirally welded pipes will not be allowed. Every 10th welding joint of mild steel pipe water main shall be tested in metallurgical laboratory for its strength.
- 6.73** The tenderer shall note that the payment towards procurement of M.S. plates for fabricating M.S. pipes / specials will be made as per tender item only. No extra charges / payment for using M.S. pipes fabricated from Fe 410 Cu-WA (copper bearing quality with

copper content between 0.17% to 0.38 % as per specifications will be entertained / considered on any account.

All the excavated material belongs to the M.C.G.M. and therefore shall be the property of MCGM. It will be mandatory on the part of tenderer to use this material in the execution of works under contract, if the quality of material available is as per the specification. The tenderer should note that if Municipal Dumping Ground is available then contractor has to dump the surplus excavated material to Municipal Dumping Ground at his own cost as directed by the engineer. In case of non- availability of Municipal dumping ground, the intending tenderer should note that the tenderer has to make his own provision/arrangements of plot in MCGM limit or outside MCGM limit at his own cost for dumping/disposal of surplus excavated material by obtaining the permission from owner of dumping site and NOC of concerned authority for debris management plant etc. No payment will be made for removal of earth of any work.

As and when royalties becomes payable to Government Authority on excavated material as per statutory requirements, the payment shall be made by the tenderer. The tenderer shall pay necessary royalties and submit documentary evidences of such payments to the Engineer for his information and records. The intending tenderer should note that, no transportation and other charges will be paid to the contractors and he has to quote their offering considering all factors.

~~6.74 M.C.G.M staff may visit the factory before and/or during fabrication of M.S pipes as directed. The contractor shall make arrangement for the factory visit at his own cost.~~

6.75 The payment for internal cement mortar lining work to water main shall be paid on the basis of diameter specified in the bill of quantities and not for actual diameter of pipe within the tolerance limit. No extra claim for payment towards variation in actual pipe diameter within tolerance limit will be considered/ entertained.

6.76 If the contract period of the tender work is 1 year (i.e. 12 month) hence the cost contingencies is not applicable for this work as per circular no. CA/WSSD/MMRDA/77 Dt. 07.05.2013.

6.77 The completion reports for various activities along with its drawing shall be submitted to the M.C.G.M immediately after execution of the work.

6.78 All the materials required to use for execution of the work to be got tested as directed by the Engineer before use.

- 6.79** Noise level shall be maintained as per circular under no.CE/ PD/ 7788/ I dated 05.11.08.
- 6.80** The tender is proposed exclusively for Dy.H.E (Const) division of Hydraulic Engineer's department.
- 6.81** The contractor has to provide vernier calliper, micro meter and digital instrument for measuring thickness of pipe/ferrule etc.
- 6.82** The tenderer shall note that the tie bars if required to be provided by drilling holes to the existing cement concrete as directed the said work shall be done as directed by the engineer without any extra/additional cost to MCGM.
- 6.83** The tenderer shall remove the water, filled for hydraulic testing of the newly laid water main/ water main stretch if required after satisfactory testing at his own cost without claiming any extra /additional cost towards dewatering to MCGM.
- 6.84** There is a paucity of space for stacking of pipes. The pipes may have to be delivered and unloaded near the site at locations far away from place of laying the pipes. However no payment will be made for double handling or transport beyond 500 meters from place of laying. No payment for retransformation, loading, unloading etc. of pipes or specials received at site for activity beyond 500 meters will be made under any circumstances. The successful bidder will have to manage transportation of pipes and specials etc. to site bearing this constraint in mind.
- 6.85** After completion of work, contractor has to submit detail location of work with three reference point and also of water main laid.
- 6.86** The contract period is exclusive of monsoon. Normally excavations are not permitted in the month of May and Tenderer shall complete refilling and reinstatement of all trenches, and the site shall be cleared in all respect including removal of surplus material on or before 15th May of every year or as directed by Engineer. During the monsoon period, i.e. from closure of excavation if any urgent work is directed, then actual working period of that working period of that work will be considered as working days.
- 6.87** Tenderer at his cost, (i.e. including cost of testing, transportation, loading, unloading of material etc complete) shall test pipes, specials, valves, cement and all other material, as directed by the Engineer. No extra payment will be made on this Account.
- 6.88** Surplus Excavated earth / concrete material / Asphalt cakes / debris on site shall be removed speedily from the site by the contractor as directed by Engineer in charge.

- 6.89** The tenderer shall arrange for and test water main at required pressure as directed at his cost, failing which, same will be carried out by the M.C.G.M at the risk and cost of the tenderer. After testing of water main, same shall be handed over to competent authority of M.C.G.M / A.E.W.W of respective wards / A.E.W.W (Maint) by the tenderer as directed.
- 6.90** The rate of supply, loading transporting on site, unloading & lowering in trenches of all kinds of pipes up to 450mm dia. is inclusive of cleaning, flushing & testing of W.M up to required pressure as directed by the Engineer.
- 6.91** If a part of completed line is required for commissioning, the same shall be handed over to the Corporation after specified testing of water main by tenderer at his cost. No extra payment, for carrying the material by head load to work site, shall be considered under any circumstances.
- 6.92** The tenderer(s) shall note that only 95% payment of payable amount will be released for the completed work and balance 5% shall be released after completing the following works:
- a) Testing of pipeline along with fittings satisfactorily.
 - b) Reinstatement of trenches.
 - c) Returning of reclaimed materials to the Municipal Store / Ward as specified.
 - d) Cleaning the site.
 - e) Clause 6.9.27 (g) shall be binding on the tenderer (s).
- 6.93** No core cut sample will be allowed in case of asphalt mix.
- 6.94** Tenderer, at their cost shall submit seven sets of “As laid” drawings of water main showing actual alignment with three point location along with the soft copy within 30 days upon submission of final bill.
- 6.95** The work may be subjected to third party audit for quality assurance. The representative of the quality assurance agency appointed for third party audit will supervise the work on day to day basis or as directed by Engineer. Tenderer should make necessary sitting arrangement for representative of this agency. The quality assurance agency will issue instructions through the site in charge of M.C.G.M. during execution of the work. All the observations, instructions made by the quality assurance agency & confirmed by M.C.G.M staff will be binding on the contractor & they should be complied accordingly by the contractor.
- 6.96** Programme of work: If at any stage the previously approved programme is required to be modified, the tenderer shall do immediately as directed by the Engineer. If it is necessary to close some phase of the work and start a new phase as directed, the tenderer shall do so

without claiming any extra payment. The programme shall be reviewed periodically and rescheduled as directed.

- 6.97** Measurement of excavation shall be as per the items in the Bill of Quantities. If the actual excavations are more than the specified, excess excavation shall not be payable. However, if the actual excavations are less than the specified but accepted by the Engineer, the same shall be paid at actual.
- 6.98** The cross connection works etc. are required to be planned in view of the water supply hours in a particular area. Extra payment shall not be considered for works carried out during early, late or night hours. The work of cross connection at the tapping point shall be undertaken immediately after starting the work. Subsequently the work of cross connection at down streamside shall be completed. In any case the cross connection works shall be completed within one month of start of laying of pipes. If tenderer fail to carry out the work within the non-supply hours, the same will be carried out by the M.C.G.M at the risk and cost of the tenderer and recoveries shall be effected from the dues payable to the tenderer.
- 6.99** The contractors will have to work during night time also and no extra claims will be entertained. The bidder shall note while working during night hours the machineries used shall comply with the noise levels as mentioned in circular No CE/PD/7788/I/dated 05.11.2008.
- 6.100** There is a paucity of space for stacking of pipes. The pipes may have to be delivered and unloaded near the site at locations far away from place of laying the pipes. However no payment will be made for double handling or transport beyond 500 meters from place of laying.
- 6.101** No payment for re-transportation, loading, unloading etc. of pipes or specials received at site for activity beyond 500 meters will be made under any circumstances. The successful bidder will have to manage transportation of pipes and specials etc. to site bearing this constraint in mind.
- 6.102** As regards payment for providing & fabricating M.S pipes, no payment will be made to contractor against the supply of M.S pipes. The payment for supply of M.S Pipes shall be made only after completing laying & welding work of M.S pipes. **However, supply of M.S fabricated pipes shall be in proportionate to the planned work of pipe laying as shown in the Bar Chart / C.P.M / P.E.R.T. Supply of M.S pipe beyond the quantity mentioned in the Bar Chart / C.P.M /P.E.R.T will not be entertained for payment towards the supply. However, if the work is ahead of the schedule the payment will be made**

accordingly. The Bidder / Contractor should note this specifically. The tenderer should note this specifically while submitting the bids & plan the work accordingly.

6.103 ~~Details of recovery of existing sluice valve replaced by the contractors in the tender work are:~~

- ~~a) For 150mm dia. S.V., recovery will be made at the rate of Rs. 595.00 per number.~~
- ~~b) For 250mm dia. S.V., recovery will be made at the rate of Rs. 2485.00 per number.~~
- ~~c) For 300mm dia. S.V., recovery will be made at the rate of Rs. 3723.00 per number.~~

6.104 ~~Item of SOR 2013, CS MW 2 b (Brick work with common burnt clay modular bricks of class designation 7.5 in foundation and plinth in: Cement mortar 1:4 (1 cement : 4 coarse sand) is included in this tender. However, many of the times modular bricks as specified in schedule of rate are not available in market and due to the emergency of the work of construction of sluice valve chamber, the same work is carried out using regular brick (for example K.B.K. Bricks) in such cases rebate of rupees 1100/- per Cu.m will be taken towards use of regular brick.~~

6.105 No extra payment will be made for cofferdam, dewatering of any source of water including dewatering of body water from water mains etc.

6.105(a) No extra payment will be made for barricading, removal of silt, removing of earth etc.

6.106 Site Office & its allied conditions:

A) On the receipt of the work order, the contractors will have to erect ready-made AC site chowky at least one number or more as directed by the Engineer in form of Porta cabin/ Container cabin or semi permanent or permanent structure with appropriate insulation from heat, and one or more Godown, before commencement of the work, without any extra cost. The contractors will obtain necessary permission from concerned Asstt. Commissioner of ward/s or competent M.C.G.M authority for suitable location for the site office/chowky, godown, place for stacking machineries & material etc. The contractors will provide following facilities, equipments, chowky, etc

i) Successful tenderer, therefore, will have to furnish information as regards the name and complete address of his bank, its branch and the bank A/C No, and Vendor Regn. form etc. along with tender document. They will have also to submit fresh information when there is any change in this regard.

ii) The Porta cabin of area preferably about 30 sq.m with air conditioner with at least two windows for proper ventilation.

iii) It should have toilet facility with necessary plumbing arrangements. After completion of the work, the chowky and toilet should be completely removed within 7 days.

iv) The Chowky should be equipped with electric supply, fans, sufficiently big tables, chairs, cupboard with locking arrangement and water filter (of approved brands) etc.

- v) The successful tenderer will have to make his own arrangement at his cost for the electric power supply required for the work either by taking connection from M.T.N.L / RELIANCE/M.S.E.B/B.E.S.T/TATA or arrange his own generators.
- vi) Tenderer, at their cost shall provide and maintain a telephone at the Engineer's site office.
- vii) The contractors are directed to make suitable arrangement in site office to prepare and maintain site record/registers so as to enable to upload the same in SAP.
- viii) Contractor shall provide 10 megapixel digital camera for taking photographs of work during execution & also later, if required.
- ix) Site godown & separate cabin/Site Laboratory adjacent to site office for contractor's staff / any other consultant / Quality control auditors if appointed by M.C.G.M as per requirement.
- x) The contractors will be given 12 mm dia or 20 mm dia (or as decided by the H.E) metered water connection for drinking purpose only if necessary. Extra water required for construction purposes will have to be brought by the contractors at his cost and no extra claims on this behalf will be entertained. The contractors have to obtain necessary permission for such connections from respective A.E.W.W of wards /Competent Authority and shall pay the necessary connection charges.

NOTE:

- i) If chowky / Site office with necessary requirements is not provided within 30 days from the date of issue of work order, a penalty of Rs 10000/- per day will be imposed.
- ii) If there is further delay more than 30 days, a penalty of Rs 20000/- per day (i.e. starting from 31st day from the date of issue of work order) will be forfeited from paid A.S.D, OR will be recovered from 1st R.A. Bill.
- iii) If there is further delay more than 45 days, a penalty of Rs 50000/- per day (i.e. starting from 46 th day from the date of issue of work order) will be forfeited from paid A.S.D, OR will be recovered from 1st R.A. Bill.

B) If any of the items except at A of the notes mentioned above is not provided, Additional penalty of Rs 1000/- per day/per item, will be imposed.

The bidders have to consider the costs of all items mentioned above and quote their % accordingly.

SITE LABORATORY:

(Space for site laboratory will not be provided by M.C.G.M)

Contractors shall set or provide a laboratory at or around the site of size about 30 sq.m before commencement of work at their cost for performing various tests and at least the following

machines and equipments shall be provided therein:

- 1) Radiometers, Torches, measuring tapes of lengths @ 3 R.m, 15 R.m, 30 R.m, & 50 R.m of approved make.
- 2) Kadappa stone platform of size 2.5 R.m x 0.9 R.m approx.
- 3) First Aid box.
- 4) Compressive testing machine (for concrete cube tests), of minimum 150 tonne capacity electrically operated and duly calibrated every 6 months. Testing machine should be maintained properly. In case of failure, the same shall be repaired or replaced within 2 days.
- 5) Set of sieves.
- 6) Sieve Shaker.
- 7) Laboratory weighing balance of minimum 20 Kg capacity, with set of standard weights, from 1gm. to 5kg. & Electronic weigh balance with least count of 1 gm. with electric operated.
- 8) Aggregate drying equipments M.S Tray of 0.6 M x 0.45 M and kerosene stove or electric hot plate.
- 9) Equipment for testing of silt content in sand.
- 10) 12 Nos of cube moulds.
- 11) Slump cone.
- 12) Infra Red thermometer calibrated upto 250 degree Celsius (for checking asphalt/bitumen temperature).
- 13) Camber Board
- 14) Electronic thermometer calibrated at least upto 300 degree Celsius and glass thermometer calibrated upto 200 degree Celsius.
- 15) Field density bottle along with cutting tray, chisel, hammer and standard sand.
- 16) Bitumen Extraction machine / Bitumen core cutting machine.
- 17) Curing tank with adequate capacities.
- 18) Density gauge – to check the field density of bituminous & sub base layers & soil strata.
- 19) Flakiness and elongation index Gauges.
- 20) 3m straight edge.
- 21) Any other machines / equipments as may be directed by the Engineer.

The laboratory shall be established ***within 30 days from the date of work order***. On failure to do so, a ***penalty of Rs 50000/- per day*** shall be imposed. All materials used prior to establishment of lab are to be tested in M.C.G.M Material Testing Laboratory (M.T.L) / other M.C.G.M approved labs.

All the test records shall be maintained in the site office & made available as & when required. The Engineer of the Contractor will conduct field density test periodically under the supervision of M.C.G.M staff /any other consultant if appointed by M.C.G.M & maintain the relevant in

records.

6.107 Instruments to be provided:

The Contractor shall provide at his own cost for the exclusive use of the staff of the Engineer all survey equipments & measuring instruments of approved make & of every kind necessary for execution of the work as and when directed by the Engineer, including:

- a) Automatic Surveyor's level (01No) with horizontal 360 degrees circle, tripod with carrying case, all to the approval of The Engineers representative. The instrument shall be calibrated as & when instructed by the Engineers representative. The same shall be kept available at all times at the site chowky.
- b) Two (2) Levelling staff 4.5 m long each in 3 sections & with attached bubbles graduated in meters & Tenths & Hundredth of a meter all to the approval of the Engineer.
- c) Two (2) Surveyors Steel Bands of which one shall be 100 Mt. long & approximately 20 mm wide & 1 shall be at least 30 Mt. long & 12 mm wide each fully divided.
- d) Two (2) thermometers for taking temperatures of Asphalt mixes.
- e) Any other instruments required for work as directed by Engineer.
Roadometers, Torches, measuring tapes of lengths @ 3 R.m, 15 R.m, 30 R.m, & 50 R.m of approved make.
- f) First Aid box

6.108 Testing of Materials:

All requests for testing of samples must be made in writing in duplicate, specifying therein the following information (separate memo should be sent for cement, concrete, steel, soil, asphalt etc.). This includes testing suggested by third party quality assurance agency through the site in-charge at tenderer's cost in Govt. approved laboratories.

- a) Name of the Work, Work Code No. if any.
- b) Type of material and tests desired (i.e. grade of cement, date of Consignment).
- c) Identification mark on the sample should be mentioned on the forwarding memo (in case of concrete beams and cubes identification marks, grade of concrete, date of casting, specimen No. should be engraved on concrete. If these details are marked by paint, samples will not be accepted. In case of reinforcement bars, details shall be displayed on label pasted on bars and label must be signed by the officer, who has taken the samples).
- d) Name and full postal address of the officer to whom the results must be sent.

- e) Date of sampling (i.e. date of laying asphalt mix, Sr. No. of load casting concrete or taking cement samples).
 - f) Name of the contractor carrying out the work.
 - g) Any other information which is specified by the user department.
1. Samples must also bear the identification mark and signature of site in-charge taking the sample. In case of samples of asphalt mixes sent in polythene bags a legible duplicate tag should be stapled from outside.
 2. Quantity of sample must be adequate as shown in the schedule, available with H.E.'s office.
 3. Full testing fees as per schedule in force shall be paid in advance between 10.30a.m and 1.00 p.m. on working days except Saturday, and between 10.30 a.m. and 12.00 noon on Saturday. These fees shall be borne by the tenderer(s).
 4. For issuing additional copies or duplicate copies Rs20/- or fees as per prevailing rates will be charge for each copy. Request for additional/duplicate copy may be made in writing by site in charge or higher officers of the user department.
 5. Cement sample should be forwarded in sealed airtight container with one lid on top not less than 10 cm. in diameter.
 6. Moulds of concrete cubes/beams taken on hire shall be returned in clean, oiled condition with all nuts and accessories in proper position.
 7. Sample for tensile testing of reinforcing bars shall be straight for entire length without bends. The ends of the bars shall be hacksaw cut and not chisel cut. One sample of each diameter bar shall be sent for first test and for retest two bars shall be sent. The length of the bars shall be 50 cm. for diameter upto 25 mm and 60 cm for dia equal to and greater than 25 mm.
 8. Samples of bitumen, cut back, emulsions shall be forwarded in wide mouthed metal containers with label pasted on the lid.
 9. Samples that are sent for testing natural moisture content shall be forwarded in wax coated packing or sealed airtight polythene bags.
 10. Undisturbed samples sent in sampling tube shall be wax coated on both Open ends.
 11. **Penalty:** The tenderers shall arrange to deliver A.M sample for testing to Municipal Testing Laboratory within 4 (four) days from the date of laying of asphalt mix on site. In case of

delay, additional testing charges as penalty would be recovered from the contractor at following rates.

- A) From 5th day to 7th day** : **Rs10000 / - per sample from date of laying asphalt mix on site.**
- B) From 8th day to 14th day** : **Rs 20000 / - per sample from date of laying asphalt mix on site.**

The above charges i.e A & B shall be paid by the contractors at the time of submitting samples in Municipal Testing Laboratory.

If the samples of A.M are not sent for testing within 14 days payment for the corresponding quantity of those samples shall not be made.

6.109 SPECIAL DIRECTIONS TO e-TENDERERS:

1. The subject work is underground & unforeseen, unplanned, unidentified nature may need to be carried out at various locations at the same time & also at adverse site conditions. The work is required to be carried within the restricted width and movement of very vehicular traffic is also required to be allowed abutting to the excavated trench. The contractor shall take utmost care/ necessary precautions/ preventive measures while carrying out the work so that vehicular traffic/pedestrians traffic shall ply safely and smoothly during the execution of work to avoid any mishap. If any mishap is happened during the execution of work the consequences of the same inclusive of legal and financial will be entirely contractor's liability and same shall be taken into account while bidding for the tender.
2. The subsoil strata may be silty/marine clay or silty clay with gravel and sand rocky strata is also likely to be encountered at some stretches of water main laying works.
3. The tenderer shall take suitable measures to protect the sides of the excavated trench at his own cost till water main laying work including allied works are completed and trench is finally reinstated.
4. The reinstatement of each stretch has to be started and completed immediately once the water main is hydraulically tested. If reinstatement is required to be carried out before hydraulic testing for any reasons whatsoever, the same will be allowed on submission of undertaking by the bidder regarding satisfactory hydraulic testing of the laid water main. In case of failure in hydraulic testing of the laid water main, the same will have to be rectified by the bidder including reinstatement at his own risk & cost.
5. Tenderer shall note that if the reinstatement work is delayed the tenderer has to take necessary steps to bring the excavated trench portion of the particular stretch in motor able and safe

conditions at his cost and no extra payment for the above mentioned works will be entertained & appropriate penalty will also be imposed.

6. The tenderer shall note that cutting of existing cement concrete road pavement by using diamond saw machine will be paid as per tender item no. HE-8-27a only. Diamond core cutter with the depth of 30 / 35 cm shall be used for uniform cutting of existing C.C pavements by the tenderer so as to avoid damage to the pavements adjacent to cutting area. If the adjacent cement concrete pavement is damaged by the contractor, the same shall be get rectified by the tenderer as directed at his own cost. No separate charges towards supplying water & electricity for the said work will be entertained / considered on any account.
7. In case misleading information of any type/matter submitted by the bidder, EMD shall be forfeited.

6.110 SPECIAL CONDITIONS OF CONTRACT

1. The work is required to be executed at one / multiple locations. The contractors will have to obtain permission accordingly from the traffic police department well in advance either for closing down the road partially/fully or for diversion of traffic for execution of the work. The contractors should therefore consider this factor while quoting.
2. The contractor shall have to obtain all the permissions of the concerned authorities of M.C.G.M / other than M.C.G.M required for carrying out the work. Only recommendatory letters will be issued by M.C.G.M.
3. Quantities of all items provided in the B.O.Q. may not be required to be executed depending upon the site conditions. For procurement of materials before starting the work, contractor shall take actual measurements on the site as per tendered work, contract period & get himself acquainted with existing site conditions. The tenderer shall not be entitled for any compensation on this account such as excess procurement of pipes, valves...etc
4. The contractor shall procure all material required for the work from manufacturers with I.S.I certificates and according to M.C.G.M specifications/approved list wherever applicable.
5. Corporation may appoint a consultant for quality audit, during execution period. The contractor will extend all help in carrying out any survey; test etc. as directed and adverse decision there of including rectification shall be carried out by the contractors at their cost.

6. All material required for the work can be stacked near the site of work in such manner so as not to cause any inconvenience to the pedestrian and vehicular traffic. If no space is available on site then tenderer shall make his own arrangement for stacking of material etc. No extra payment will be made on this account.
7. The contractor should note that during the execution of the work the excavated material will have to be removed immediately after completion of the work as per direction of the Engineer, failing which the same will be got removed at their risk and cost. The site shall be cleared by removal of surplus material within 24 hours after refilling the excavated trench.
8. For uneven size of chamber and chamber prone to heavy traffic, contractor should submit the chamber cover design through structural consultant on MCGM panel on approval of design by E.E.W.W.(Civil)Maint / A.E.W.W.(Civil)Maint, work to be executed.
9. ~~*The contractor has to make transportation arrangement (Four wheeler equivalent to Indica, not less than 3 year old) for Engineers and his staff round the clock 24/7 till completion of the work for smooth working and supervision of the subject work. The transportation arrangement shall be provided from the date of starting of the work. The contractor shall solely responsible for running and upkeep of transport vehicle including all taxes, insurance, toll, license, tools, fuel, oil, lubricants, repairs and maintenance and shall also provide competent driver with vehicle. Failing which Rs. 5000.00 penalty shall be imposed on contractor. In case of breakdown of vehicle an alternative equivalent vehicle shall be provided immediately. No payment will be made by MCGM for this transport arrangement.*~~

6.111 Concrete Works:

1. All concrete works shall be carried out by Ready Mix Concrete / unless otherwise specified in respective items.
2. Testing for compressive strength of concrete works shall be carried out as per the Quality Assurance Manual, or as directed by engineer in-charge. Twelve cubes (150 mm x 150 mm x 150 mm) shall be cast & tested for compressive strength for 7, 14 & 28 days at the site laboratory. For concrete of grade M 35 or higher, corresponding three flexural beams (700 mm x 150 mm x 150 mm) for flexural strength of 28 days shall also be cast & tested, for every day's work at the laboratory attached to the R.M.C. plant. In case of failure in compressive strength for 28 days, the remaining three cubes shall be sent to the municipal laboratory or any other laboratory approved by Ch.E (Rds & Tr.), as directed by engineer in-charge for re-testing.

3. Besides, once in a month, compressive strength for 7, 14 & 28 days & flexural strength for 28 days (for concrete of grade M 35 or higher) shall be carried out at municipal laboratory or approved laboratory as directed by engineer in-charge.
4. The temperature of Pavement Quality concrete shall be maintained as per IRC: 15:2002. Concrete having temperature at the time of pouring more than 30°C will not be allowed.
5. The tenderer should note that channels (form work) of specific sizes (150mm, 280 mm or 300 mm or 350 mm) may have to be manufactured as per the design of concrete pavement slab for which no extra payment will be made and tenderer has to quote his % rate accordingly.
6. The contractors shall make necessary arrangement for adequate lighting during night-time & as per the conditions insisted by Traffic police department N.O.C for the work. No extra claims will be entertained for the same.
7. List of approved Paver block manufacturers/ Asphalt Plants/ R.M.C. Plants etc. have been incorporated in this document. However, M.C.G.M. reserves right to modify these lists. (The updated list of approved paver blocks manufacturers at “the time of execution of works” shall be obtained from the Dy.Chief Engineer (Roads) City / E.S’s office.
8. All the asphalt works required to be done under the captioned contract shall be got executed with the specified asphalt mixes manufactured in M.C.G.M. approved asphalt plants only.
9. All the Paver blocks/ Kerb stones/ Water tables/ Frame & covers required for the works to be carried out under the captioned contract shall be procured from the specified manufacturers registered with M.C.G.M. only and also the interlocking paver blocks shall have BIS registration.
10. The RMC works required to be done under the captioned contract shall be got executed with pre-qualified / approved RMC plant by M.C.G.M.
11. While casting tree guard the guidelines mentioned in section 7.9.15 shall be followed.

6.112 Traffic Management:

1. The contractor shall have to provide adequate number of wardens as per requirement of Traffic Police Deptt. at the contractor's cost.
2. Traffic signs – Temporary traffic and construction signs are to be provided during construction and maintenance operations for traffic diversion and pedestrian safety as per Traffic Diversion Plan.

3. The contractor shall display the boards stating information of the name of the work, date of starting, date of completion, name of the Deptt. and contact telephone no's of Contractor's Engineer.
4. While constructing/improving footpath, provision for sloping ramp of at least 1m width or as directed, shall be made at every carriage entrance, junctions, bus stops etc., for convenience of physically challenged persons.
5. The full time service of the Personnel Team of the contractor is mandatory during the entire period of the project.
6. Diameter of the S.W.D pipe & sizes of manholes provided in the bill of quantities of the tenders are tentative & are likely to change at the time of execution according to the site conditions. Contractor's shall have to carry out such extra items in S.W.D works as per S.W.D schedule rates of M.C.G.M prevailing at the time of execution of work or as per G.C.C adjusted by rebate/ premium quoted by the contractors and no fair rate will be admissible for the same.
7. The photographs of work sites & works as and when directed by Engineer are to be taken. A new Digital Camera of Min 10 Mega Pixels shall be provided in the site office for the said purpose. The Photographs should be arranged in the Album/ Register showing the relevant activities executed on site. The register should be duly signed by site-in-charge and contractor fortnightly. All photographs may require to be uploaded as & when directed to do so.

6.113 Price Variation:

The bidder shall note that as the time period of project is 12 (Twelve) months (Excluding Monsoon), hence the cost contingencies/ price variation for labour & materials shall be considered as per circular under no Dy.Ch.E/WSP/CI/08/3387 dated 02.01.09 and will be paid as per indices issued by competent authority considering the relevant clauses of **G.C.C. in force** & amendments thereof by the MCGM from time to time. However, maximum limit for reimbursement is **5 %** of the contract cost (including extra items/excess quantities but excluding water/ sewerage and supervision charges & physical and cost contingencies. The bidder shall note this aspect and submit their bid accordingly.

6.114 Every running bill submitted by the contractor for payment shall be with the detailed measurements recorded for each item.

6.115 Contract Labour (Abolition and Regulation) Act 1970: The Tenderer(s) should specifically note that the successful tenderer shall have to strictly comply with all the statutory requirement under the provision of the Contract Labour (Abolition and Regulation) Act 1970 and with the Maharashtra State Contract Labour (Abolition and Regulation) Rules 1970 and indemnify the Corporation against any claim(s) whatsoever. The Contractor has to check healths of all the labours employed by him at every fortnight and take precautionary measures and treatments as per advice of medical officer. If record is not maintained, penalty of *Rs1000/- per labour* will be imposed.

6.116 Royalty Payment on excavated material as per statutory requirement:

The contractor shall pay necessary royalties as and when royalties becomes payable to the government authority on excavated material as per statutory requirements. The payment towards royalty charges shall be made by the contractor & it will not be reimbursed by M.C.G.M. The evidences of such payment shall be submitted for record purpose.

6.117 If the contractor carries out excavation for any tender / additional work allotted & fails to reinstate the same within the stipulated time limit, as per the programme and or before 15th of May OR any other date specified by the M.C.G.M authority, the reinstatement will be got carried out at contractor's risk and cost through other agency in addition to further penal action.

6.118 The noise level shall be maintained within the permissible limit in Silence zone area during the construction activities by the Contractors, as per the notification dated 14.2.2000, issued by the Ministry of Environment & Forests.

6.119 The contractor shall maintain copy of the following registers during execution of work and it is mandatory to provide Laptops / Desktops to the Site Engineers for the same. The List of Registers / Records / Files etc to be maintained is as under:

<i>Sr.No</i>	<i>Name of Register / Records / Files</i>
<i>01</i>	<i>Daily Progress Register</i>
<i>02</i>	<i>Excavation Register (Soil, C.C, Road carriageways, Rock ... etc)</i>
<i>03</i>	<i>Correspondence File</i>

04	<i>External & Internal utility remarks File</i>
05	<i>Permission File (Ward / Traffic / Chowky / C.C.Road ... etc)</i>
06	<i>Permission File (Other utility letters viz S.P, S.W.D, S.O, B.E.ST, TATA, M.G.L, M.T.N.L, Railway, Mb.P.T, M.S.R.D.C, M.M.R.D.A ... etc)</i>
07	<i>O/C File</i>
08	<i>Drawing File</i>
09	<i>Instruction Book / Register</i>
10	<i>Level Book if required</i>
11	<i>Mix Design Approval File if required</i>
12	<i>Test Report File (Cement, Sand, Brick, Metal No 1, Metal No 2, Metal No 3, Rock ... etc)</i>
13	<i>Test Report File (Sluice Valve (S.V), Butterfly Valve (B.F.V), Air Valve ... etc)</i>
14	<i>Test Report File (Paver block, G.S.B, W.M.M, D.L.C, M40 RMC ... etc)</i>
15	<i>Test Report File (Asphalt Macadam, Asphalt Concrete ... etc)</i>
16	<i>Test Report File (Pipes, Welding ... etc)</i>
17	<i>Pipe Laying Register</i>
18	<i>Form Work / Shuttering Register if required</i>
19	<i>Encasement Register if required</i>
20	<i>Cement Variation Register if required</i>
21	<i>Cement Register</i>
22	<i>Sub base & W.B.M Register if required</i>
23	<i>Asphalt Macadam, Asphalt Concrete Qty Register if required</i>
24	<i>Asphalt Macadam / Concrete Challan File if required</i>
25	<i>G.S.B, W.M.M Register if required</i>
26	<i>D.L.C Register if required</i>
27	<i>Duct Pipe / Lateral Register</i>
28	<i>Steel Register if required</i>
29	<i>M10, M15, M20 C.C Qty, Cube, Variation Registers</i>
30	<i>M10, M15, M20, M35 / M40 RMC Qty, Cube, Variation Registers</i>
31	<i>R.M.C Challan File if required</i>
32	<i>Pour Card Register if required</i>
33	<i>Joint Cutting Register if required</i>
34	<i>Precast Item Register (Paver blocks, Kerb stone, Dividers etc) if required</i>
35	<i>Precast Item Challan Register if required</i>

36	<i>R.T.I Correspondence File</i>
37	<i>Vigilance Reply File</i>
38	<i>Railway Correspondence File if required</i>
39	<i>Isolation Memo File</i>
40	<i>Hydraulic Testing File</i>
41	<i>Handing Over File</i>
42	<i>Photograph File / Album / Register</i>
43	<i>Penalty Register</i>
45	<i>Sand Metal Register if required</i>
46	<i>M8 Register if required</i>
47	<i>Any other registers required as per description of items for any activity / material / quantity for which payment is made or as instructed by M.C.G.M staff.</i>

6.120 IMPORTANT POINTS TO BE NOTED BY THE TENDERER:

1. The successful tenderer/ Contractor have to co-ordinate between the third party quality assurance agency, if any, and the M.C.G.M. staff for the quality execution of work.
2. All materials required to be used for execution of the job shall be got tested as directed by third party quality auditor, if any, through the site in-charge before use.
3. The contractor shall prepare all the relevant site records/registers & duly update the same in consultation with the site in-charge.
4. The jobs allotted to the contractor for execution is to be executed to the satisfaction of the third party quality assurance agency if any and the M.C.G.M. The contractor to note this point and plan the execution of work carefully.
5. The completion reports for various activities along with its drawing are required to be submitted to the MCGM immediately after execution of the job.
6. It is suggested to the contractor that the contractor may make necessary arrangement for testing of the water main.
7. The overall quantum of the work may vary to any extent and if the scope of the work is reduced to any extent, the contractor shall not claim any compensation and no payment will be made towards claim/ compensation. If the quantum of the work get exceed tender amount, the contractor has to execute the work for additional amount at the same quoted percentage. This point shall be considered while quoting the tender.

8. The cost contingencies/ price variation for labour & materials shall be considered as per circular under no Dy.H.E's/WSP/CI/08/3387 dated 02.01.09 and will be paid as per indices issued by competent authority considering the relevant clauses of G.C.C. in force & amendments thereof by the MCGM from time to time. However, maximum limit for reimbursement is 5 % of the contract cost (including extra items/excess quantities but excluding water/ sewage and supervision charges & physical and cost contingencies.

9. **For extra/excess prior administrative approval of the competent approving authority mentioned in the circular u/no. Dir/ES&P/324 DT. 15.07.2015 is mandatory for execution of extra/excess work. However, if quantities of excess items executed in the work is less than 5% prior/post facto approval of the competent authority shall be obtained**

However, prior administrative sanctioning authorities for excess/extra/saving are as per following table:-

Nature of work	Permissible limit % of excess/Extra/saving of contract cost	Approving Authority		
		Dir(ES&P)/ DMC(E)/DMC(SE)	A.M.C.	M.C.
Underground works	25 %	Upto 5%	Above 5% upto 15%	Above15% upto 25%

For extra/fair items if any prior administrative approval shall be obtained from the AMC(P) & maximum limit is 5% of total contract cost.

Contractors are informed that the circular under reference is issued for the propose of having financial discipline on the work hence whenever the quantity executed to the extent of 80% of BOQ quantity will be intimated to Site In Charge before executing the work on site & or submission of R.A. bill for the said work. The extra/excess beyond the BOQ quantity are likely to be operative, the contractor need to take prior approval of competent authority. Any amendment in circular mentioned above during the time period of this tender will be applicable. The foreclosure of work due to above circular & reason will not be the cause of claiming compensation of this work.

6.121 Special Notes:

- 1) The pipe fabrication factory must have facility of automatic welding machine and hydraulic testing set up.
- 2) The spiral welding is not allowed for M.S pipes.

3) ~~The contractor has to make arrangement for factory visit of Municipal staff
at his own cost.~~

4) The contractor has to lay as far as possible the water mains at fixed level by diverting the utilities if required. Also preferably bends to be used while laying w.m. should be less than of 45 degree.

For extra item, if required to execute, any unforeseen work as per site conditions, HE's Schedule of rates will be mainly considered for the payment of work with proper sanction from DMC (SE). However, if the items are not available in HE's schedule those item will be paid as per the items of other MCGM Schedule of rates & as stipulated in the relevant clause of G.C.C. If the items are not available in any of the M.C.G.M. schedules, then fair rate will be prepared as per prevailing market rate with 15% contractors profit inclusive of overheads and duly got verified by Account Office. For fair rate approval from DMC (SE) shall be obtained before execution of work or afterward as the case may be. Contractors will be asked to refill the trenches with excavated earth with proper compaction as specified in clause PL 52 of Technical Specifications and reinstatement of Road surface to its original road surface. The width of road surface to be reinstated will be restricted to the trench width plus 15 cm on either side or as directed. The contractor has to maintain the reinstated trench and reinstated road surface till the defect liability period of the contract period is over at his cost. Any settlement of reinstated trench and/or reinstated road surface is observed during this period shall be redone within 7 days by contractor's at his cost failing which it will attract penalty equivalent to the cost of reinstatement (at quoted rate) of the portion per week or part thereof or as per the policy guidelines for reinstatement of trenches and the same will be recovered from the contractor's bill. However, during monsoon period if any pothole / settled trench is observed, it shall be binding on Contractors to attend it within 24 / 48 hours as the case may be and as directed by the Engineer.

6.122 SITE INSPECTION:

Before submitting the tender, the Tenderers / Contractors shall inspect and acquaint himself about the site of construction with its site constraints. They shall also collect such information as they may deem necessary for the proper execution of the works. They shall obtain further clarification, if any, on any specific issue from the Deputy Hydraulic Engineer (Maint) / Executive Engineer (Head Work) Water Works, the offices of whom are situated at Municipal Ghatkooar Water Works Yard, LBS Marg, Kama Lane, Mumbai – 400 086 before submitting the tender. Tenderers / Contractors should note and study the condition related to site constraints

and its impact.

6.123 SITE CONSTRAINTS:

The Tenderers / bidders should note following points carefully before quoting:

- 1) *For execution of proposed subject work along with its various allied work within contractual period the bidders has to carry out the work at number of locations as directed. Department will apply for necessary permissions to traffic department / Tree Authority / concerned M.C.GM ward / any other agency as may be required. However, necessary follow ups shall have to be made by the contractor to get the permissions so as to start & complete the work within stipulated time period. Getting aforesaid permissions will be entirely contractor's responsibility for which the required help will be provided by M.C.GM. Also, the directions of authority concerned with regards to traffic diversions / for any other purpose will be binding on the contractor.*
- 2) While carrying out the work, contractor has to ensure safety of existing utilities of B.S.N.L, B.E.S.T, TATA, SCADA, M.G.L, optical fibre cables, Sewer lines, S.W.D & Water Mains of Hydraulic Engineer's Department etc. contractor has to take care of all his Machineries and transport vehicles while executing the work without disturbing traffic flow on remaining carriageway of road. If any damage occurs to any immediately and no extra payment will be made to the contractors.
- 3) Existing Cross Drainage work/HT cables /High voltage/oil filled TATA cables/ Drains etc may required to be crossed by way of diversions or by deepening the pipeline as directed. Utmost care should be taken while carrying out such works to avoid the damage to the existing utilities. If any damage occurs to any of the utility, same will have to be repaired /reinstated by the contractor at his cost immediately and no extra payment will be made to the contractor.
- 4) It is to be ensured by the contractor that all valve chamber covers shall flush with the top of the existing road.
- 5) Due to paucity of space and to ensure better & consistent quality, it is necessary to provide Ready Mix Concrete (R.M.C) for the concreting works required for the project or as the case may be.
- 6) *Very hard rock is likely to be met with in certain stretches which will have to be necessarily excavated mechanically. This must be done by deploying sufficient no. of Poclairn or any other mechanical means (L&T KOMAT'SU PC 300 LC OR equivalent or higher in capacity) considering available access point to the strip of land for laying of pipeline, all in*

commensuration with time constraints for execution of total work. No blasting including controlled blasting will be permitted under any circumstances. The contractor may be required to deploy power driven rock splitters or chemicals like Acconix or equivalent for breaking the hard rock. The bidder shall carefully evaluate this constraint before quoting the rate under this item of work.

- 7) The warranty period of valves will however commence from the physical completion of entire work under the contract.
- 8) *The bidder shall note that he will have to arrange for security and safety of Municipal and his own staff working at the site & materials stacked at / near to sites during the whole contract period and the cost of same shall be deemed to have been covered under items of the contract. The bidders/Contractors should note that, no claim whatsoever arising out of the ignorance of site conditions etc submitted later on, will be entertained on any account.*
- 9) As stated in scope of the tender, this tender covers the work of providing and laying of various dia water mains& its allied civil works. The work of interconnections / cross Connections of various dia. water mains shall have to be done in restricted time limit as the existing water mains are live ones and it is to be carried out only after isolation for very restricted time period is permitted by Hydraulic Engineer.

6.124 ASSISTANCE FOR THE ENGINEER'S STAFF:

The Contractor shall provide all necessary assistance to the Engineer's Representative and his staff in carrying out their duties of checking, setting out, inspecting and measuring the works. The Contractor shall provide surveyor, staff men, office attendants and labourers as may be needed from time to time by the Engineer.

The Contractor shall provide for Engineer and his staff protective clothing, safety helmets, rubber boots of suitable sizes, hand lamps, and the likes as may reasonably be required by them. These articles shall remain the property of the Contractor. No separate payment shall be made on this account.

6.125 SAFETY MEASURES AND SERVICES:

The Contractor shall be responsible for the safety of all workmen and other persons entering the works and shall take all measures necessary to ensure their safety to the approval of the Engineer's Representative. The guidelines are as under:

- a) Display of proper safety and emergency regulations; fire, gas and electric shock precautions, provisions of stretchers and first aid boxes together with rescue facilities for each place of working.

- b) Provision of efficient safety helmets for all personnel including the Engineer's Representative and each of his staff and any authorized visitors.
- c) Safe control of water, including provision of ample standby generating and pumping plant;
- d) Provision and maintenance of suitable lighting to provide adequate illumination of works with appropriate spares and standby equipment;
- e) Provision and maintenance of safe, sound mechanical equipment each item of plant having an up-to-date test certificate;
- f) Provision and maintenance of safe, sound ropes, slings, pulleys and other lifting tackle, each appliance having an up-to-date test certificate where appropriate;
- g) Provision of notice board 1.25 m x 1.5 min size, written in bold letter in English, Marathi and Hindi, to be erected on existing footpaths and points of access likely to be used by the public, which shall warn the public.

6.126 IDLE CHARGES:

No idle charges will be entertained on any of the grounds.

SECTION 7

SCOPE OF WORK

➤ **This particular tender comes under the category of “Regular and Routine works”.**

Project specific scope of work includes:

Name of work: Reconstruction of compound wall along Trunk Main on R. N. Gandhi Marg in N ward.

1. Demolition of existing wall
2. Excavation for re-construction of wall
3. RCC work in foundation & Superstructure
4. SWD work
5. Plastering & Painting work.
6. M.S. work.
7. Footpath work
8. The trees affected in the alignment shall be removed by obtaining permission from Tree authority.
9. The successful tenderer (s) shall have to deposit the requisite amount with tree authority for faithful compliance of requirements.

Note:

1. Contractor shall appoint MCGM registered RCC Consultant and soil investigation agency at his own cost to carry out the necessary designs, built drawings and shall get the drawings approved by the office of Executive Engineer W.W. (Civil) Maint.
2. The bidder shall note that the total station survey at the proposed tender work site inclusive of all existing surrounding details shall be carried out before starting of the work and after completion of work free of cost; no extra payment shall be made for the same.

SECTION 8

BILL OF QUANTITIES

बृहन्मुंबई महानगरपालिका
(जल अभियंता विभाग)

Name of Work: Reconstruction of Compound wall along Trunk Mains on R.N. Gandhi Marg in N-Ward

ABSTRACT SHEET

Sr. No	Item No.	Description	Qty	Unit	Rate	Amount
1	R2- CS- DD-5- b	Demolishing stone rubble masonry manually/ by mechanical means including stacking of serviceable material and disposal of unserviceable material within 50 metres lead as per direction of Engineer-in-charge : In cement mortar.	510. 00	Cum	1393 .00	₹ 7,10,430.00

2	R2- CS- EW-1	Excavation for foundations, substructures, basements, tanks, sumps, walls, chambers, manholes, trenches, poles, pits & general building works in all types of soils, vegetable earth, soft murum, running sand, shingle, turf clay, loam, peat, ash, shale, slag, chalk, garbage, muddy/ marshy/ slushy soil, marine clay, reclaimed land etc. for depths/lifts upto 1.5M measured from the ground level, including dressing/ trimming the sides, leveling and ramming of bottoms, manual dewatering, removing rank vegetation, backfilling in layers not more than 200mm thickness, watering, consolidating, compacting to achieve not less than 97% Modified Proctor density conforming to relevant IS, stacking the selected material in measurable heaps for future use within owners space or disposing within an initial lead of 150m as directed, loading, unloading, levelling excluding shoring, strutting etc. complete as directed by Engineer-in-Charge. Note: 1) The rate includes the handling/supporting the existing utilities such as cables, drains, pipes, water mains etc. 2) It also includes the royalty and other taxes applicable if any. For more details refer General Notes.	1050 .00	Cum	307. 00	₹ 3,22,350.00
3	R2- CS- EW-2- a	Extra over above item CS-EW-1 for lift from 1.5m to 3.0m.	450. 00	Cum	71.0 0	₹ 31,950.00
4	R2- CS- EW-2- b	Extra over above item CS-EW-1 for lift from 3.0m to 4.5m	70.0 0	Cum	106. 00	₹ 7,420.00

5	R2- CS- EW-3	Excavation for foundation, substructures, basements, tanks, sumps, walls, chambers, manholes, trenches, poles, pits & general building works in soft/ disintegrated rock, sand stone, stiff clay, gravel, cobblestone, hard laterite, water bound macadam, wet mix macadam, asphalt mix carpet of any type, pitching, soling, paths and hardcore, lime concrete, plain cement concrete, stone masonry and all types of brick/ block masonry below ground level, rock boulders, etc. for depths/ lifts upto 1.5M measured from the ground level, including dressing/ trimming the sides, leveling of bottoms, manual dewatering, removing rank vegetation, backfilling in layers not more than 200mm thickness, watering, consolidating, compacting to achieve not less than 97% Modified Proctor density conforming to relevant IS, stacking in measurable heaps for future use within owners space or disposing within an initial lead of 150m as directed, loading, unloading, leveling excluding shoring, strutting etc. complete as directed by Engineer-in-Charge. Note: 1) The rate includes the handling/supporting the existing utilities such as cables, drains, pipes, water mains etc. 2) It also includes the royalty and other taxes if any. . For more details refer General Notes.	1350 .00	Cum	500. 00	₹ 6,75,000.00
6	R2- CS- EW-7- a	Extra over the items CS-EW-03 to CS-EW-06 for lift from 1.5m to 3.0m.	380. 00	Cum	127. 00	₹ 48,260.00
7	R2- CS- DD-2	Demolishing R.C.C. slab, R.C.C. wall of any thickness, R.C.C. beams, joists, R.C.C. columns, piles, pile caps etc., in any thickness and size manually/ by mechanical means including stacking of steel bars and disposal of unserviceable material within 50 metres lead as per direction of Engineer - in- charge.	165. 00	Cum	1837 .00	₹ 3,03,105.00

8	R2- CS- EW- 26	Providing & Laying dry stone Rubble Soling with average 230 mm size hard stone set in regular lines, handpacked and interstices thoroughly filled with small chips including filling in with good quality murum brought from outside, compacting with iron rammers, watering, sand spreading 12mm thk. layer of grit on top etc complete as directed by Engineer In Charge. (Note: The rate includes the royalty and other taxes if any)	170. 00	Cum	2231 .00	₹ 3,79,270.00
9	R2- CS- EW- 28	Providing and laying dry rubble stone packing with Municipal rubble hand set in regular lines, interstices being filled in with small pieces of stones, throughly rammed, consolidated and watered complete as directed and specified.	60.0 0	Cum	1391 .00	₹ 83,460.00
10	R2- CS- CW-3- a-2	Providing and laying in position ready mixed plain cement concrete, with cement content as per approved design mix by Engineer-in-charge and manufactured in fully automatic batching plant and transported to site of work in transit mixer for all leads, having continuous agitated mixer, manufactured as per mix design of specified grade for plain cement concrete work, including pumping of R.M.C. from transit mixer to site of laying and curing, including the cost of centering, shuttering and finishing, including cost of curing, admixtures in recommended proportions as per IS : 9103 to accelerate/ retard setting of concrete, improve workability without impairing strength and durability as per direction of the Engineer - in - charge. All works upto plinth level. M-15 grade plain cement concrete (cement content considered @ 240 kg/cum as per IS 456 table showing minimum cement content).	160. 00	Cum	6764 .00	₹ 10,82,240.00

11	R2- CS- CW-7- a	Providing and laying in position ready mixed design mix M-20 grade cement concrete for reinforced cement concrete work, using cement content as per approved design mix, including pumping of concrete to site of laying and the cost of centering, shuttering, finishing and excluding reinforcement, including admixtures in recommended proportions as per IS: 9103 to accelerate, retard setting of concrete, improve workability without impairing strength and durability as per direction of Engineer-in-charge. The Mix design as per particular specifications shall be got approved by Engineer-in-Charge before execution of the item. The rate shall include cost of all specified materials and operations at all levels and heights, including the cost of centering, shuttering and and excluding reinforcement which shall be paid under relevant item. (Note :- Cement content considered in this item is @ 300 kg/cum as per IS 456 table showing minimum cement content. No extra will be paid nor any amount will be recovered on account of variation of cement in mix design as per specifications for controlled concrete). Foundations, footings, bases of columns, rafts, pilecap	380. 00	Cum	7515 .00	₹ 28,55,700.00
12	R2- CS- CW-7- b	Walls (any thickness) including attached buttresses, retaining wall, shear wall, diaphragm wall, trench, pit walls, etc	550. 00	Cum	1051 8.00	₹ 57,84,900.00
13	R2- CS- CW-7- c	Slabs, Suspended floors, roofs, landings, balconies, canopy and access platform	115. 00	Cum	1179 0.00	₹ 13,55,850.00
14	R2- CS- CW- 17	Extra and over for providing richer RMC of M-30 grade cement concrete instead of M20 (Note :- Cement content considered in this item is @ 340 kg/cum as per IS 456 table showing minimum cement content.) showing minimum cement content.)	1045 .00	Cum	532. 00	₹ 5,55,940.00

15	R2- CS- CW- 35-c	Providing and fixing in position steel bars reinforcement of various diameters for R.C.C. pile, pile caps, footings,raft,retaining wall,shear wall, lift wall, foundations, slabs, beams, columns, canopies, staircases, new-els, chajjas, lintels, pardies, coping, fins, arches, etc. as per detailed designs, drawings and bar bending schedules,including straightening, cutting, bending, hooking the bars, binding with wires or tack welding, supporting as required etc. all complete at all levels.Thermo-Mechanically Treated steel bars. (Fe 500 D)	125. 00	MT	7677 0.00	₹ 95,96,250.00
16	R2- CS- CW- 46-a	Providing and laying premoulded asphalt filler for expansion joints cut to the required depth and camber. 12mm thk	100. 00	Rmt	699. 00	₹ 69,900.00
17	R2- BW-5- 3-c	Providing and applying epoxy base paint to RCC piers, columns, beams, girders, diaphragms, slabs, parapets etc. including cleaning the surfaces thoroughly so as to remove deposited salts, oil, grease, tar, moisture etc. from the surface, preparing the surface, applying putty consisting of epoxy base paint and steolite powder, to render the concrete surfaces smooth by covering small irregularities and applying one coat of epoxy paint including scaffolding etc. complete as specified and directed.(2 coats epoxy + primer)	2700 .00	Sqm	412. 00	₹ 11,12,400.00

18	R2- RW-7- 32	Providing and placing in position, levelling, fixing M 25 Grade R.C.C. pre-cast frame of size 1150 x 1150 x 150 mm and cover (2 Nos) of size 1000mm x 500mm x 75mm in line, level over storm water drain as per design procured from approved manufacturer etc. complete	85.0 0	Nos	2896 .00	₹ 2,46,160.00
19	R2- BW-3- 11	Providing weep holes in Brick masonry/Plain/Reinforced concrete abutment, wing wall/return wall with 100 mm dia PVC pipe, extending through the full width of the structure with slope of 1V :20H towards drawing face. Complete as per drawing and Technical specifications	1090 .00	Each	281. 00	₹ 3,06,290.00
20	R2- CS- SL-13	Providing and Fixing Decorative / Ornamental grills as per design for compound wall / Fencing including fabricating the grill using M.S. square / round bar, flats and angles including painting with one coat of red oxide zinc chromate primer and two coats of synthetic enamel paint of approved colour and brand etc. complete as directed.	1200 0.00	KG	184. 00	₹ 22,08,000.00

21	R2- CS- SS-16	<p>Providing, detailing, and fabricating as per specifications, transporting to site and erecting MS Openable / Sliding / Ornamental Entrance Gates including track and wheel, locking arrangement, fixing bolts, nuts, washers, cleats, stiffeners, gussets decorative balusters, arrow heads etc. and all necessary operations like straightening, bending, cutting, drilling, grinding, machining if specified, welding etc. complete weighing 60 to 65kg/Sqm, including cleaning, Grinding and removing the welding burr and preparing surface and applying one coat of red oxide zinc chromate primer and one coat of Synthetic Enamel paint after fabrication and second coat of Synthetic Enamel paint after erection, with approved colour, shade and brand etc. including touching up with primer etc. complete as directed by Engineer In Charge.</p>	65.0 0	Sqm	7834 .00	₹ 5,09,210.00
----	---------------------	---	-----------	-----	-------------	---------------

22	R2- RW- 10-63	Extra Over Item of stencil concrete above M-20 in footpath : Providing, applying and finishing the top surface of M-20 concrete with stamp/stencil of approved pattern and colour, in accordance with manufacturer's specification of any approved brand of colour hardener @ of 3.5kg/sq.m, including floating of colour hardened over concrete surface with different types of floaters; including application of release agent @ of 0.15 kgs/sq.m, stamping over the concrete surface with stamping tools; including cleaning of surface with water and cutting of finished concrete; including application of two coats of acrylic based sealer for finishing. Colour hardener and release agent shall be tested for abrasion resistance for a depth of wear, should not be more than 0.025 mm. Coverage of sealer should not be more than 6.5 sq.m. per one litre coat; including cost of skilled manpower, cutting machine, sprayer and all tools tackies for all activities; complete smooth & finish as per direction of Engineer-In-Charge	560. 00	Sqm	436. 00	₹ 2,44,160.00
23	R2- RW-8- 03	P/L 300mm dia. R.C.C. hume pipes, NP2 class, jointing, filling in 1:1 C.M., including plugging of both the ends with gunny bags, brick masonry in C.M. 1:4 with plaster in C.M. 1:4 & curing etc. complete, as specified as directed.	85.0 0	Rmt	796. 00	₹ 67,660.00

24	R2- RW- 10-50	Providing and fixing of cement concrete Kerb Stone of various grades of size: 500mm width x 325 height x 165mm thick (Half Batter, BullNose / Full Batter) manufactured in wet press vacuum dewatering technology plant / equivalent with face pimple finish for high visibility with excellent quality and finish and edges perfect and sharp. Grade –M-25. Including excavation in any soil except rock, laying a leveling course of M 15 grade RMC 100mm. thick, to required slope (inclusive of form work) jointing in C.M.1:2 proportion flush to concrete surface, painting exposed surface with one coat of primer and two coats of 1st grade road marking paint in the yellow/white/black or any shade as directed. (Kerbstones shall be procured from MCGM registered agencies).	380. 00	Rmt	1116 .00	₹ 4,24,080.00
25	R2- RW-4- 06	Providing & fixing water tables of stone of size 30 cm wide and 10 cm thick, fairly dressed on a R.M.C.M-20 cement concrete bed 15 cm. thick, including filling in the joints, with cement mortar 1:2 cement pointing, curing etc. complete as specified and as directed by the Engineer.	380. 00	Rmt	462. 00	₹ 1,75,560.00
26	R2- SWD- 143	Constructing single water entrance of internal size 0.45m x 0.45m with cast-in-situ coping in M-20 grade, fixing of grating in M -20 as per standard drawings (Dwg No. MCGM/SWD/2013-11), etc complete as specified and as directed by Engineer in Charge. (excluding excavation, providing and fixing of gratings and frame)	85.0 0	Each	1057 5.00	₹ 8,98,875.00

27	R2-SWD-168	Providing & Fixing 0.45m X 0.45m clear internal size of M.S. Galvanised hinged type grating and frame (weighing minimum 53 kg) with minimum 75 microns zinc coating by hot dipped galvanising the MS grating and frame as per IS 2629. (The contractor shall furnish the certificate of galvanising from the Galvaniser.) including testing, inspection of material sample and finished product in presence of M.C.G.M. Engineers (3 nos.) at Manufacturers works, as per Standard Specification no SP-SWD-2 and as per drawing (Dwg No. MCGM/SWD/2013-08), etc complete as specified & as directed by Engineer in Charge.	85.00	Each	7363.00	₹ 6,25,855.00
28	R2-CS-MW-3-b	Brick work with common burnt clay F.P.S. (non modular) bricks of class designation 3.5 and above in superstructure above plinth level upto floor five level in all shapes and sizes in : Cement mortar 1:4 (1 cement : 4 coarse sand)	40.00	Cum	6930.00	₹ 2,77,200.00
29	R2-CS-PL-14-a	Providing and applying 12 mm thick sand faced external cement plaster for soffit of slabs & stair, beams, columns, chajja etc. upto 10m from ground level and at all locations in cement mortar as specified below including providing waterproofing compound to the first coat of plaster as per manufacturers specification, hacking of concrete surface, finishing, curing, scaffolding etc complete as directed By Engineer In Charge.	450.00	Sqm	322.00	₹ 1,44,900.00
Total Estimated Cost						₹ 3,11,02,375.00
Say as						₹ 3,11,02,375.00

SECTION 9

GENERAL CONDITIONS

OF CONTRACT

General Conditions of Contract

A. General

1. Definitions

1.1 Terms which are defined in the Contract Data are not also defined in the Conditions of Contract but keep their defined meanings. Capital initials are used to identify defined terms.

The “Contract” shall mean the tender and acceptance thereof and the formal agreement if any, executed between the Contractor, Commissioner and the Corporation together with the documents referred to therein including these conditions and appendices and any special conditions, the specifications, designs, drawings, price schedules, bills of quantities and schedule of rates. All these documents taken together shall be deemed to form one Contract and shall be complementary to one another.

The Contract Data defines the documents and other information which comprise the Contract.

The “Contractor” shall mean the individual or firm or company whether incorporated or not, whose tender has been accepted by the employer and the legal successor of the individual or firm or company, but not (except with the consent of the Employer) any assignee of such person.

The Bidder is a person or corporate body who has desired to submit Bid to carry out the Works, including routine maintenance till the tender process is concluded.

The Contractor's Bid is the completed bidding document submitted by the Contractor to the Employer.

The “Contract Sum” means the sum named in the letter of acceptance including Physical contingencies subject to such addition thereto or deduction there-from as may be made under the provisions hereinafter contained.

Note : The contract sum shall include the following –

- In the case of percentage rate contracts the estimated value of works as mentioned in the tender adjusted by the Contractor’s percentage.
- In the case of item rate contracts, the cost of the work arrived at after finalization of the quantities shown in schedule of items / quantities by the item rates quoted by the tenderers for various items and summation of the extended cost of each item.
- In case of lump sum contract, the sum for which tender is accepted.

- Special discount / rebate / trade discount offered by the tenderer if any and accepted by the Corporation.
- Additions or deletions that are accepted after opening of the tenders.

The “Contract Cost” means the Contract Sum plus Price Variation. This cost shall be included in the letter of acceptance.

A Defect is any part of the Works not completed in accordance with the Contract.

The Defects Liability Certificate is the certificate issued by the Engineer, after the Defect Liability Period has ended and upon correction of Defects by the Contractor.

Drawings means all the drawings, calculations and technical information of a like nature provided by the Engineer to the Contractor under the Contract and all drawings, calculations, samples, patterns, models, operation & maintenance manual and other technical information of like nature submitted by the Contractor and approved by the Engineer.

The Authority shall mean Municipal Corporation of Greater Mumbai (MCGM)

The “Employer” shall mean the Municipal Corporation for Greater Mumbai / Municipal Commissioner for Greater Mumbai, for the time being holding the said office and also his successors and shall also include all “Additional Municipal Commissioners, Director (Engineering Services & Projects)” and the Deputy Municipal Commissioner, to whom the powers of Municipal Commissioner, have been deputed under Section 56 and 56B of the Mumbai Municipal Corporation Act.

The Engineer in-charge shall mean the Executive Engineer in executive charge of the works and shall include the superior officers of the Engineering department i.e. Dy.Ch.Eng/Ch.Eng. and shall mean and include all the successors in MCGM

The Engineer's Representative shall mean the Assistant Engineer, Sub. Engineer/Jr. Engineer in direct charge of the works and shall include Sub Eng./ Jr. Eng of Civil section/ Mechanical section/ Electrical section appointed by MCGM.

The “Engineer” shall mean the City Engineer / the Hydraulic Engineer / the Chief Engineer / the Special Engineer, appointed for the time being or any other officer or officers of the Municipal Corporation who may be authorized by the commissioner to carry out the functions of the City Engineer / the Hydraulic Engineer / the Chief Engineer / the Special Engineer or any other competent person appointed by the employer and notified in writing to the Contractor to act in replacement of the Engineer from time to time.

Contractor's Equipment means all appliances and things of whatsoever nature required for the execution and completions of the Works and the remedying of any defects therein, but does not include plant material or other things intended to form or forming part of the Permanent Works.

The Initial Contract Price is the Contract Price listed in the Employer's Letter of Acceptance.

The Intended Completion Date is the date on which it is intended that the Contractor shall complete the construction works. The Intended Completion Date is specified in the Contract Data. The Intended Completion Date may be revised only by the Engineer by issuing an extension of time.

Materials are all supplies, including consumables, used by the Contractor for incorporation in the Works and works of routine maintenance.

Plant is any integral part of the Works that shall have a mechanical, electrical, electronic, chemical, or biological function.

Routine Maintenance is the maintenance of activities of the completed structure for five years as specified in the Contract Data.

The "Site" shall mean the land and other places including water bodies more specifically mentioned in the special conditions of the tender, on, under in or through which the permanent works or temporary works are to be executed and any other lands and places provided by the Municipal Corporation for working space or any other purpose as may be specifically designated in the contract as forming part of the site.

Site Investigation Reports are those that were included in the bidding documents and are reports about the surface and subsurface conditions at the Site.

"Specification" shall mean the specification referred to in the tender and any modification thereof or addition or deduction thereto as may from time to time be furnished or approved in writing by the Engineer.

The Start Date/Commencement Date is given in the Contract Data. It is the date when the Contractor shall commence execution of the Works. It does not necessarily coincide with any of the Site Possession Dates.

A Nominated Sub-Contractor is a person or corporate body who has a Contract with the Contractor to carry out a part of the construction work and/or routine maintenance in the Contract, which includes work on the Site.

Temporary Works are works designed, constructed, installed, and removed by the Contractor that are needed for construction or installation of the Works.

Variation means a change to the:-

- i) Specification and /or Drawings (if any) which is instructed by the Employer.
- ii) Scope in the Contract which is instructed by the Employer.
- iii) Price in the Contract which is instructed by the Employer.

The Works, as defined in the Contract Data, are what the Contract requires the Contractor to construct, install, maintain, and turn over to the Employer. Routine maintenance is defined separately.

Jurisdiction: In case of any claim, dispute or difference arising in respect of a contract, the cause of action thereof shall be deemed to have arisen in Mumbai and all legal proceedings in respect of any claim, dispute or difference shall be instituted in a competent court in the City of Mumbai only.

2. Interpretation

2.1 In interpreting these Conditions of Contract, singular also means plural, male also means female or neuter, and the other way around. Headings have no significance. Words have their normal meaning under the language of the Contract unless specifically defined. The Engineer will provide instructions clarifying queries about these Conditions of Contract.

2.2 If sectional completion is specified in the Contract Data, references in the Conditions of Contract to the Works, the Completion Date, and the Intended Completion Date apply to any Section of the Works (other than references to the Completion Date and Intended Completion Date for the whole of the Works).

2.3 The documents forming the Contract shall be interpreted in the following documents: (1) Agreement, (2) Letter of Acceptance, (3) Notice to Proceed with the Work, (4) Contractor's Bid, (5) Contract Data, (6) Special Conditions of Contract Part (7) General Conditions of Contract Part I, (8) Specifications, (9) Drawings, (10) Bill of Quantities, and (11) Any other document listed in the Contract Data.

3. Engineer's Decisions

3.1 Except where otherwise specifically stated, the Engineer will decide contractual matters between the Employer and the Contractor in the role representing the Employer. However, if the Engineer is required under the rules and regulations and orders of the Employer to obtain prior

approval of some other authorities for specific actions, he will so obtain the approval, before communicating his decision to the Contractor.

3.2 Except as expressly stated in the Contract, the Engineer shall not have any authority to relieve the Contractor of any of his obligations under the contract.

4. Delegation

4.1 The Engineer, with the approval of the Employer, may delegate any of his duties and responsibilities to other person(s), except to the Adjudicator, after notifying the Contractor, and may cancel any delegation after notifying the Contractor.

5. Communications

All certificates, notices or instructions to be given to the Contractor by Employer/ Engineer shall be sent on the address or contact details given by the Contractor of Bid. The address and contact details for communication with the Employer/ Engineer shall be as per the details given in Contract Data. Communications between parties that are referred to in the conditions shall be in writing. The Notice sent by facsimile (fax) or other electronic means shall be effective on confirmation of the transmission. The Notice sent by Registered post or Speed post shall be effective on delivery or at the expiry of the normal delivery period as undertaken by the postal service.

6. Subcontracting

6.1 Unless specifically mentioned in the contract subletting will not be allowed. Subletting, where otherwise provided by the contract shall not be more than 25% of the contract price.

6.2 The Contractor shall not be required to obtain any consent from the Employer for:

- a. the sub-contracting of any part of the Works for which the Subcontractor is named in the Contract;
- b. the provision for labour, or labour component.
- c. the purchase of Materials which are in accordance with the standards specified in the Contract.

6.3 Beyond what has been stated in clauses 6.1 and 6.2, if the Contractor proposes sub contracting any part of the work during execution of the Works, because of some unforeseen circumstances to enable him to complete the Works as per terms of the Contract, the Employer will consider the following before according approval:

- a. The Contractor shall not sub-contract the whole of the Works.
- b. The permitted subletting of work by the Contractor shall not establish any contractual relationship between the sub-contractor and the MCGM and shall not relieve the Contractor of any responsibility under the Contract.

6.4 The Engineer should satisfy himself before recommending to the Employer whether

- a. the circumstances warrant such sub-contracting; and
- b. the sub-Contractor so proposed for the Work possesses the experience, qualifications and equipment necessary for the job proposed to be entrusted to him.

7. Other Contractors

7.1 The Contractor shall cooperate and share the Site with other Contractors, public authorities, utilities, and the Employer between the dates given in the Schedule of Other Contractors, as referred to in the Contract Data. The Contractor shall also provide facilities and services for them as described in the Schedule. The Employer may modify the Schedule of Other Contractors, and shall notify the Contractor of any such modification.

7.2 The Contractor should take up the works in convenient reaches as decided by the Engineer to ensure there is least hindrance to the smooth flow and safety of traffic including movement of vehicles and equipment of other Contractors till the completion of the Works.

8. Personnel

8.1 The Contractor shall employ for the construction work and routine maintenance the key personnel including technical personnel named in the Contract Data or other personnel approved by the Engineer. The Engineer will approve any proposed replacement of technical personnel only if their relevant qualifications and abilities are substantially equal to those of the personnel stated in the Contract Data.

8.2 The Contractor's personnel shall appropriately be qualified, skilled and experienced in their respective trades or occupations. The Engineer shall have authority to remove, or cause to be removed, any person employed on the site or works, who carries out duties incompetently or negligently and persists in any conduct which is prejudicial to safety, health or the protection of the environment.

8.3 If the Engineer asks the Contractor to remove a person who is a member of the Contractor's staff or work force, stating the reasons, the Contractor shall ensure that the person leaves the Site within seven days and has no further connection with the Works in the Contract.

8.4 The Contractor shall not employ any retired Gazetted officer who has worked in the Engineering Department of the MCGM /State Government and has either not completed two years after the date of retirement or has not obtained MCGM/State Government's permission to employment with the Contractor.

9. Employer's and Contractor's Risks

9.1 The Employer carries the risks which this Contract states are Employer's risks, and the Contractor carries the risks which this Contract states are Contractor's risks.

10. Employer's Risks

10.1 The Employer is responsible for the excepted risks which are (a) in so far as they directly affect the execution of the Works in the Employer's country, the risks of war, invasion, act of foreign enemies, rebellion, revolution, insurrection or military or usurped power, civil war, riot, commotion or disorder (unless restricted to the Contractor's employees) and contamination from any nuclear fuel or nuclear waste or radioactive toxic explosive, or (b) a cause due solely to the design of the Works, other than the Contractor's design.

11. Contractor's Risks

11.1 All risks of loss of or damage to physical property and of personal injury and death which arise during and in consequence of the performance of the Contract other than the excepted risks, referred to in clause 11.1, are the responsibility of the Contractor.

12. Insurance

12.1 The Contractor at his cost shall provide, in the joint names of the Employer and the Contractor, insurance cover from the Start Date to the end of Defects Liability Period, in the amounts and deductibles stated in the Contract Data for the following events which are due to the Contractor's risks:

- a) Loss of or damage to the Works, Plant and Materials;
- b) Loss of or damage to Equipment;

c) Loss of or damage to property (other than the Works, Plant, Materials, and Equipment) in connection with the Contract; and

d) Personal injury or death.

12.2 Insurance policies and certificates for insurance shall be delivered by the Contractor to the Engineer for the Engineer's approval before the Start Date. All such insurance shall provide for compensation to be payable in the types and proportions of currencies required to rectify the loss or damage incurred.

12.3 Alterations to the terms of insurance shall not be made without the approval of the Engineer.

12.4 Both parties shall comply with any conditions of the insurance policies.

12.5 If the Contractor does not provide any of the policies and certificates required, the Employer may affect the insurance which the Contractor should have provided and recover the premiums the Employer has paid, from payments otherwise due to the Contractor or if no payment is due, the payment of premiums shall be debt due.

13. Site Investigation Reports

13.1 The Contractor, in preparing the Bid, may rely, at his own risk, on any Site Investigation Reports referred to in the Contract Data, supplemented by any other information available to him, before submitting the bid.

14. Queries about the Contract Data

14.1 The Engineer will clarify queries on the Contract Data.

15. Contractor to Construct the Works and Undertake Maintenance (if specified in the tender)

15.1 The Contractor shall construct, and install and maintain the Works in accordance with the Specifications and Drawings and as per instructions of the Engineer.

15.2 The Contractor shall construct the works with intermediate technology, i.e., by manual means with medium input of machinery required to ensure the quality of works as per specifications. The Contractor shall deploy the equipment and machinery as required in the contract.

15.3 The Contractor shall take all reasonable steps to protect the environment on and off the Site and to avoid damage or nuisance to persons or to property of the public or

others resulting from pollution, noise or other causes arising as a consequence of his methods of operation.

During continuance of the contract, the Contractor and his sub-contractors shall abide at all times by all existing enactments on environmental protection and rules made there under, regulations, notifications and byelaws of the State or Central Government, or local authorities and any other law, bye-law, regulations that may be passed or notification that may be issued in future by the State or Central Government or the local authority. Salient features of some of the major laws that are applicable are given below:

- The Water (Prevention and Control of Pollution) Act, 1974, this provides for the prevention and control of water pollution and the maintaining and restoring of wholesomeness of water. 'Pollution' means such contamination of water or such alteration of the physical, chemical or biological properties of water or such discharge of any sewage or trade effluent or of any other liquid, gaseous or solid substance into water (whether directly or indirectly) as may, or is likely to, create a nuisance or render such water harmful or injurious to public health or safety, or to domestic, commercial, industrial, agricultural or other legitimate uses, or to the life and health of animals or plants or of aquatic organisms.
- The Air (Prevention and Control of Pollution) Act, 1981, this provides for prevention, control and abatement of air pollution. 'Air Pollution' means the presence in the atmosphere of any 'air pollutant', which means any solid, liquid or gaseous substance (including noise) present in the atmosphere in such concentration as may be or tend to be injurious to human beings or other living creatures or plants or property or environment.
- The Environment (Protection) Act, 1986, this provides for the protection and improvement of environment and for matters connected therewith, and the prevention of hazards to human beings, other living creatures, plants and property. 'Environment' includes water, air and land and the inter-relationship which exists among and between water, air and land, and human beings, other living creatures, plants, micro-organism and property.
- The Public Liability Insurance Act, 1991, This provides for public liability insurance for the purpose of providing immediate relief to the persons affected by accident occurring while handling hazardous substances and for matters connected

herewith or incidental thereto. Hazardous substance means any substance or preparation which is defined as hazardous substance under the Environment (Protection) Act 1986, and exceeding such quantity as may be specified by notification by the Central Government.

16. The Works and Routine Maintenance to be completed by the Intended Completion Date

16.1 The Contractor may commence execution of the Works on the Start Date and shall carry out the Works and Routine Maintenance, if specified in the tender, in accordance with the Programme submitted by the Contractor, as updated with the approval of the Engineer, and complete them by the Intended Completion Date.

17. Approval by the Engineer

17.1 The Contractor shall submit Specifications and Drawings showing the proposed Temporary Works to the Engineer, who is to approve them if they comply with the Specifications and Drawings.

17.2 The Contractor shall be responsible for design and safety of Temporary Works.

17.3 The Engineer's approval shall not alter the Contractor's responsibility for design and safety of the Temporary Works.

17.4 The Contractor shall obtain approval of third parties to the design of the Temporary Works, where required.

17.5 All Drawings prepared by the Contractor for the execution of the temporary or permanent Works, are subject to prior approval by the Engineer before their use.

18. Safety

18.1 The Contractor shall be responsible for the safety of all activities on the Site. He shall comply with all applicable safety requirements and take care of safety of all persons entitled to be on the site and the works. He shall use reasonable efforts to keep the site and the works, both during construction and maintenance, clear of unnecessary obstruction so as to avoid danger to the persons and the users.

- Workers employed on mixing asphaltic materials, cement and lime mortars shall be provided with protective footwear and protective goggles.
- Stone breaker shall be provided with protective goggles and protective clothing and seated at sufficiently safe intervals.

- The area should be barricaded or cordoned off by suitable means to avoid mishaps of any kind. Power warning signs should be displayed for the safety of the public whenever cleaning works are undertaken during night or day.
- The workers engaged for cleaning the manholes/sewers should be properly trained before allowing working in the manhole.

18.2 Safety Programs:-

- I. Have adequate safety supervision in place to ensure that safety programs set up by the firms/agencies are in compliance with prevalent laws and regulations.
- II. Review safety programs developed by each of the trade firms, prepare and submit a comprehensive safety program.
- III. Monitor day to day implementation of safety procedures.

18.3 First Aid Facilities: -

- i. At every work place there shall be provided and maintained, so as to be easily accessible during working hours, first-aid boxes at the rate of not less than one box for 150 contract labour or part thereof ordinarily employed.
- ii. The first-aid box shall be distinctly marked with a red cross on white back ground.
- iii. Adequate arrangements shall be made for immediate recoupment of the equipment when necessary.
- iv. Nothing except the prescribed contents shall be kept in the First-aid box.
- v. The first-aid box shall be kept in charge of a responsible person who shall always be readily available during the working hours of the work place.
- vi. A person in charge of the First-aid box shall be a person trained in First-aid treatment, in the work places where the number of contract labour employed is 150 or more.

19. Discoveries

19.1 Anything of historical or other interest or of significant value unexpectedly discovered on the Site shall be the property of the Employer. The Contractor shall notify the Engineer of such discoveries and carry out the Engineer's instructions for dealing with them.

20. Possession of the Site

20.1 The Employer shall handover complete or part possession of the site to the Contractor 7 days in advance of construction programme. At the start of the work, the Employer shall handover the possession of at-least 75% of the site free of all encumbrances, the remaining 25 % of the possession as per contractor's construction programme.

21. Access to the Site

21.1 The Contractor shall allow access to the Site and to any place where work in connection with the Contract is being carried out, or is intended to be carried out to the Engineer and any person/persons/agency authorized by: a. The Engineer b. The Employer or authorized by the Employer.

22. Instructions

22.1 The Contractor shall carry out all instructions of the Engineer, which comply with the applicable laws where the Site is located.

22.2 The Contractor shall permit the appointed and/or authorized persons to inspect the Site and/or accounts and records of the Contractor and its subcontractors relating to the performance of the Contract, and to have such accounts and records audited by auditors appointed, if so required. The Contractor's attention is invited to Clause of 'Fraud and Corruption', which provides, inter alia, that acts intended to materially impede the exercise of the inspection and audit rights provided for under the Clause & constitute a obstructive practice subject to contract termination.

22.3 Engineer to have power to issue further drawings or instructions:

The Engineer shall have the power and authority from time to time and at all times to make and issue such further drawings and to give such further instructions and directions as may appear to him necessary or proper for the guidance of the contractor and the good and sufficient execution of the works according to terms of the specifications and Contractor shall receive, execute, obey and be bound by the same, according to the true intent and meaning thereof, as fully and effectually as though the same had accompanied or had been mentioned or referred to in the specification, and the Engineer may also alter or vary the levels or position of nature of works contemplated by the specifications, or may order any of the works contemplated thereby to be omitted, with or without the substitution of any other works in lieu thereof, or may order any work or any portion of work executed or partially executed, to be removed, changed or altered, added if needful, may order that other works shall be substituted instead thereof and difference of expense occasioned by any such diminution or alteration so ordered and directed shall be added to

or deducted from the amount of this Contract, as provided under condition no.10(a) hereinafter.

No work which radically changes the original nature of the Contract shall be ordered by the Engineer and in the event of any deviation being ordered which in the opinion of the Contractor changes the original nature of Contract he shall nevertheless carry it out and disagreement as to the nature of the work and the rate to be paid therefore shall be resolved in accordance with condition no.13d.

The time for completion of the Works, shall be in even of any deviations resulting in additional cost over the contract price being ordered, be extended or reduced reasonably by the Engineer. The Engineer's decision in this case shall be final.

B. Time Control

23. Programme

23.1 Within the time stated in the Contract Data, the Contractor shall submit to the Engineer for approval a Programme, including Environment Management Plan showing the general methods, arrangements, order, and timing for all the activities in the Works, along with monthly cash flow forecasts for the construction of works.

After the completion of the construction works, the programme for the Routine Maintenance Work, showing the general methods, arrangements, order and timing for all the activities involved in the Routine Maintenance will also be submitted by the Contractor to the Engineer for approval if specified in the tender. The programme for Routine Maintenance will be submitted in each year for the period of Maintenance.

23.2 The Contractor shall submit the list of equipment and machinery being brought to site, the list of key personnel being deployed, the list of machinery/ equipments being placed in field laboratory and the location of field laboratory along with the Programme. The Engineer shall cause these details to be verified at each appropriate stage of the programme.

23.3 An update of the Programme shall be a programme showing the actual progress achieved on each activity and the effect of the progress achieved on the timing of the remaining Works, including any changes to the sequence of the activities.

23.4 The Contractor shall submit to the Engineer for approval an updated Programme at intervals no longer than the period stated in the Contract Data. If the Contractor does not

submit an updated Programme within this period, the Engineer may withhold the amount stated in the Contract Data from the next payment certificate and continue to withhold this amount until the next payment after the date on which the overdue Programme has been submitted.

23.5 The Engineer's approval of the Programme shall not alter the Contractor's obligations. The Contractor may revise the Programme and submit it to the Engineer again at any time. A revised Programme shall show the effect of Variations and Compensation Events.

24. Extension Of Time In Contracts :

Subject to any requirement in the contract as to completion of any portions or portions of the works before completion of the whole, the contractor shall fully and finally complete the whole of the works comprised in the contract (with such modifications as may be directed under conditions of this contract) by the date entered in the contract or extended date in terms of the following clauses:

a) Extension attributable to MCGM

(i) Extension Due To Modification: If any modifications have been ordered which in the opinion of the Engineer have materially increased the magnitude of the work, then such extension of the contracted date of completion may be granted as shall appear to the Engineer to be reasonable in the circumstances, provided moreover that the Contractor shall be responsible for requesting such extension of the date as may be considered necessary as soon as the cause thereof shall arise and in any case **should not be less than 30 days before the expiry of the date fixed for completion of the works.**

(ii) Extension For Delay Due To MCGM: In the event of any failure or delay by the MCGM to hand over the Contractor possession of the lands necessary for the execution of the works or to give the necessary notice to commence the works or to provide the necessary drawings or instructions or any other delay caused by the MCGM due to any other cause whatsoever, then such failure or delay shall in no way affect or vitiate the contract or alter the character thereof or entitle the contractor to damages or compensation therefore, but in any such case, the MCGM may grant such extension(s) of the completion date as may be considered reasonable.

Note: For extension of time period as governed in (i) and (ii) above, any modifications in design/drawings, specifications, quantities shall be needed to be justified with recorded reasons with approval of Ch.Eng. for not anticipating the same while preparing estimates and draft tender.

(b) Extension Of Time For Delay Due To Contractor : The time for the execution of the work or part of the works specified in the contract documents shall be deemed to be the essence of the contract and the works must be completed no later than the date(s) / the programme for completion of work as specified in the contract. If the contractor fails to complete the works within the time as specified in the contract for the reasons other than the reasons specified in above as (a.i) and (a.ii), the MCGM may, if satisfied that the works can be completed by the contractor within reasonable short time thereafter, allow the contractor for further extension of time as the Engineer

may decide. On such extension the MCGM will be entitled without prejudice to any other right and remedy available on that behalf, to recover the compensation as governed by Clause 8(e) of GCC.

For the purpose of this Clause, the contract value of the works shall be taken as value of work as per contract agreement including any supplementary work order/contract agreement issued.

Further, competent authority while granting extension to the currency of contract under Clause (b) of as above may also consider levy of penalty, as deemed fit based on the merit of the case. Also, the reasons for granting extension shall be properly documented.

25. Delays Ordered by the Engineer

25.1 The Engineer may instruct the Contractor to delay the start or progress of any activity within the Works. Delay/delays totaling more than 30 days will require prior written approval of the DMC/AMC.

26. Management Meetings

26.1 The Engineer may require the Contractor to attend a management meeting. The business of a management meeting shall be to review the plans for progress of the Works.

26.2 The Engineer shall record the business of management meetings and provide copies of the record to those attending the meeting. The responsibility of the parties for actions to be taken shall be decided by the Engineer either at the management meeting or after the management meeting and stated in writing to all those who attended the meeting.

C. Quality Control

27.1. Work to be open to Inspection and Contractor or Responsible agent to be present

All works under or in course of execution or executed in pursuance of the contract shall at all times be open to the inspection and supervision of the Eng-in-charge and his subordinates and the contractor shall at all times during the usual working hours, at all other times, during the usual working hours and at all other times at which reasonable notice of the intention of the Eng-in-charge and his subordinates to visit the works shall have been given to the contractor, either himself be present to receive orders and instruction or have responsible agent duly accredited in writing present for that purpose. Order given to the contractors' duly authorized agent shall be considered to have the same force and effect as if they had been given to the contractor himself.

27.2. Notice To Be Given Before Work Is Covered Up

The contractor shall give not less than ten days' notice in writing to the Eng-In-Charge or his subordinate incharge of the work before covering up or otherwise placing beyond the reach of

measurement any work in order that the same may be measured and correct dimension thereof taken before the same is so covered up or placed beyond the reach of measurements and shall not cover up or place beyond the reach of measurement any work without the consent in writing of the Eng-In-Charge or his subordinate incharge of the work, and if any work shall be covered up or placed beyond the reach of measurement, without such notice having been given or consent obtained the same shall be uncovered at the contractors expenses, and in default thereof no payment or allowance shall be made for such work or for the materials with which the same was executed

27.3 Works to be executed in accordance with specifications / drawings / orders etc. :

The contractor shall execute the whole and every part of the work the most substantial and workman like manner and both has regards material and every other respect in strict accordance with specifications. The contractor shall also confirm exactly, fully and faithfully to the designs, drawings and instructions in writing relating to the work signed by the Engineer In-charge and lodged in his office and to which the contractor shall be entitled to have access for the purpose of inspection at such office, or on the site or work during office hours. The contractor shall be entitled to receive three sets of contract drawings and working drawings as well as one certified copy of the accepted tender along with the work order free of cost.

27.4 Ready Mix Concrete/ Asphalt Mix

- i) The contractor shall have to arrange Ready Mix concrete (RMC)/Asphalt from RMC/ASPHALT producing plants registered with MCGM
- ii) The contractor shall, within 7 days of award of the work, submit a list of at least three RMC/Asphalt producers with details of such plants including details and number of transit, mixers & pumps etc. to be deployed indicating name of owner/company, its location, capacity, technical establishment.

The Engineer-in-charge will reserve right to inspect at any stage and reject the concrete if he is not satisfied about quality of product at the user's end.

- iii) The Engineer-in-charge reserves the right to exercise control over the:-
 - a) Calibration check of the RMC/Asphalt plant.
 - b) Weight and quantity check on the ingredients, water and admixtures added for batch mixing for RMC plants
 - c) Time of mixing of concrete/grade of asphalt.

- d) Testing of fresh concrete/asphalt mix, recording of results and declaring the mix fit or unfit for use. This will include continuous control on the work ability during production and taking corrective action, if required.
- e) For exercising such control, the Engineer-in-charge shall periodically depute his authorized representative at the RMC/Asphalt plant. It shall be responsibility of the contractor to ensure that all necessary equipment, manpower & facilities are made available to Engineer-in-charge and or his authorized representative at RMC/Asphalt plant.
- f) All required relevant records of RMC/Asphalt mix shall be made available to the Engineer-in-charge or his authorized representative. Engineer-in-charge shall, as required, specify guidelines & additional procedures for quality control & other parameters in respect of material production& transportation of concrete mix which shall be binding on the contractor & the RMC/Asphalt plant. Only concrete as approved in design mix by Engineer-in-charge shall be produced in RMC plant and transported to the site.
- g) The contractor shall have to produce a copy of challan receipts/SCADA reports/VTS reports as issued by the RMC/Asphalt plant as a documentary proof in lieu of supply of RMC/Asphalt mix before releasing payment.

28. Identifying Defects

- 28.1 The Engineer shall check the Contractor's work and notify the Contractor of any Defects that are found. Such checking shall not affect the Contractor's responsibilities. The Engineer may instruct the Contractor to search for a Defect and to uncover and test any work that the Engineer considers may have a Defect.
- 28.2 The Contractor shall permit the Employer's technical person(s) to check the Contractor's work and notify the Engineer and Contractor if any defects that are found.

29. Tests

- 29.1 For carrying out mandatory tests as prescribed in the specifications, the Contractor shall establish field laboratory at the location decided by Engineer. The field laboratory will have minimum of equipments as specified in the Contract Data. The contractor shall be solely responsible for:

- a. Carrying out the mandatory tests prescribed in the Specifications, and

b. For the correctness of the test results, whether preformed in his laboratory or elsewhere.

29.2 If the Engineer instructs the Contractor to carry out a test not specified in the Specification/ Quality Assurance Handbook to check whether any work has a Defect and the test shows that it does, the Contractor shall pay for the test and any samples. If there is no defect, the test shall be a compensation event.

When required by the Engineer-in-charge the contractor(s) shall supply for the purpose of testing samples of all materials proposed to be used in the works. Samples submitted either to govern bulk supplies or required for testing before use shall be in suitable packages to contain them and shall be provided free of charge by the contractor. The cost of testing shall be borne by the contractor even if the result of the sample confirm or do not confirm to the relevant BIS code specifications.

- i. All expenditure required to be incurred for taking the samples conveyance, packing shall be borne by the contractor himself.
- ii. The failed material shall be removed from the site by the contractor at his own cost within a week time of written order of the Engineer-in-charge.

29.3 Setting of Site Laboratories:

Contractors shall set up a laboratory at site before commencement of work at their cost for performing various tests and at least the following machines and equipments shall be provided therein –

1. Set of Sieves as per I.R.C. /I.S.
2. Compressive Testing Machine(For new works)
3. Oven, Electrically Operated
4. Weighing Balance (20 kg capacity)
5. 3 m straight edge
6. Sieve shaker
7. First Aid Box
8. Measuring Jar (for silt content)
9. Other Machines/apparatus as may be directed by the Engineer
10. Vernier Caliber
11. Level / Theodolite

All the test records shall be maintained in the site office and made available as and when required. The laboratory must be established within 15 days from the date of receipt of the orders from Engineer In charge. On failure to do so, a penalty of Rs 1000/- per day shall be imposed.

The contractor shall install testing equipment at site. The contractor shall ensure and certify the calibration of the equipment so installed and shall maintain the same in working order throughout the period of construction. The contractor shall also provide necessary technically qualified experienced trained staff for carrying out such tests for using such equipment. The tests shall be carried out under the supervision of the Engineer-in-charge. The calibration shall be checked every twelve months as directed by Engineer-in-charge.

30. Correction of Defects noticed during the Defects Liability Period.

30.1 (a) The Engineer shall give notice to the Contractor of any Defects before the end of the Defects Liability Period, which begins at Completion and ends after five years. The Defects Liability Period shall be extended for as long as Defects remain to be corrected.

(b) Every time notice of Defect/Defects is given, the Contractor shall correct the notified Defect/Defects within the duration of time specified by the Engineer's notice.

(c) The Engineer may issue notice to the Contractor to carry out removal of defects or deficiencies, if any, noticed in his inspection, or brought to his notice. The Contractor shall remove the defects and deficiencies within the period specified in the notice and submit to the Engineer a compliance report.

31. Uncorrected Defects and Deficiencies

31.1 If the Contractor has not corrected a Defect pertaining to the Defect Liability Period under clause and deficiencies in maintenance, to the satisfaction of the Engineer, within the time specified in the Engineer's notice, the Engineer will assess the cost of having the Defect or deficiency corrected, and the Contractor shall pay this amount, on correction of the Defect or deficiency by another agency.

D. Cost Control

32. Variations

The Engineer shall, having regard to the scope of the Works and the sanctioned estimated cost, have power to order, in writing, Variations within the scope of the Works he considers necessary or advisable during the progress of the Works. Such Variations shall form part of the Contract and the Contractor shall carry them out and include them in updated Programmes

produced by the Contractor. Oral orders of the Engineer for Variations, unless followed by written confirmation, shall not be taken into account.

33. Payments for Variations

33.1 If rates for Variation items are specified in the Bill of Quantities, the Contractor shall carry out such work at the same rate.

33.2 The rate for Extra/Excess shall be governed by clause 10.A of Standard General Condition of Contract

34. Cash Flow Forecasts

When the Programme is updated, the Contractor shall provide the Engineer with an updated cash flow forecast.

35. Payment Certificates

The payment to the Contractor will be as follows for construction work:

- (a) A bill shall be submitted by the Contractor monthly or before the date fixed by the Engineer In-charge for all works executed in the previous month, and the Engineer In-charge shall take or cause to be taken requisite measurement for the purpose of having the same verified and the claim, so far as it is admissible, shall be adjusted, if possible, within 10 days from the presentation of the bill. If the contractor does not submit the bill within the time fixed as aforesaid, the Engineer In-charge may depute a subordinate to measure up the said work in the presence of the contractor or his duly authorized agent whose counter signature to the measurement list shall be sufficient warrant, and Engineer In-Charge may prepare a bill from such list which shall be binding on the contractor in all respects.
- (b) The Engineer shall check the Contractor's fortnightly/monthly statement within 14 days and certify the amount to be paid to the Contractor.
- (c) The value of work executed shall be determined, based on measurements by the Engineer.
- (d) The value of work executed shall comprise the value of the quantities of the items in the Bill of Quantities completed.
- (e) The value of work executed shall also include the valuation of Variations and Compensation Events.

(f) The Engineer may exclude any item certified in a previous certificate or reduce the proportion of any item previously certified in any certificate in the light of later information.

(g) The contractor shall submit all bills on the printed forms at the office of Engineer In-charge. The charges to be made in the bills shall always be entered at the rates specified in tender.

36. Payments

36.1 Payments shall be adjusted for deductions for advance payments, retention, security deposit, other recoveries in terms of the Contract and taxes at source, as applicable under the law. The Employer shall pay the Contractor the amounts certified by the Engineer within 15 days of the date of each certificate.

36.2 All sums payable by a contractor by way of compensation under any of these conditions, shall be considered as a reasonable compensation to be applied to the use of MCGM without reference to the actual loss or damage sustained and whether any damage has or has not been sustained.

36.3 No payment shall be made for any work estimated to cost less than Rupees One Thousand till after the whole of work shall have been completed and the certificate of completion given. But in the case of works estimated to cost more than Rs. One Thousand, the contractor shall on submitting a monthly bill therefore be entitled to receive payment proportionate to the part of the work than approved and passed by the Engineer In-charge, whose certificate of such approval and passing of the sum so payable shall be final and conclusive against the contractor. All such intermediate payments shall be regarded as payments by way of advance against the final payments only and not as payments for work actual done and completed and shall not preclude the Engineer In-charge from requiring any bad, unsound, imperfect or unskillful work to be removed or taken away and reconstructed or re-erected nor shall any such payment be considered as an admission of the due performance of the contract or any part thereof in any respect or the offering of any claim not shall it conclude, determine or effect in any other way, the powers of the Engineer In-charge as to the final settlement and adjustment of the accounts or otherwise, or in any other way vary or effect the contract. The final bill shall be submitted by the Contractor within one month of the date fixed for the completion of the work otherwise the Engineer In-charge's certificate of the measurements and of the total amount payable for the work shall be final and binding on all parties.

37. The Contractor shall not be entitled to compensation to the extent that the Employer's interests are adversely affected by the Contractor for not having given early warning or not having cooperated with the Engineer.

38. Tax

G.S.T. and other state levies/cess which are not subsumed under GST will be applicable. The tenderer shall quote inclusive of all taxes. It is clearly understood that MCGM will not bear any additional liability towards payment of any Taxes & Duties.

Wherever the Services to be provided by the Tenderers falls under Reverse Charge Mechanism, the Price quoted shall be exclusive of GST, but inclusive of Taxes / Duties / Cess other than GST, if any.

Rates accepted by MCGM shall hold good till completion of work and no additional individual claim shall be admissible on account of fluctuations in market rates; increase in taxes/any other levies/tolls etc. except that payment/recovery for overall market situation shall be made as per Price Variation.

39. **Currencies:** - All payments will be made in Indian Rupees.

40. Liquidated Damages

Both, the Contractor and the Employer have agreed that it is not feasible to precisely estimate the amount of losses due to delay in completion of works and the losses to the public and the economy, therefore, both the parties have agreed that the Contractor shall pay liquidated damages to the Employer and not by way of penalty, at the rate per week or part thereof stated in the Contract Data for the period that the Completion Date is later than the Intended Completion Date. Liquidated damages at the same rates shall be withheld if the Contractor fails to achieve the milestones prescribed in the Contract Data. However, in case the Contractor achieves the next milestone, the amount of the liquidated damages already withheld shall be restored to the Contractor by adjustment in the next payment certificate. The Employer and the contractor have agreed that this is a reasonable agreed amount of liquidated damage. The Employer may deduct liquidated damages from payments due to the Contractor. Payment of liquidated damages shall not affect the Contractor's other liabilities.

41. Cost of Repairs

Loss or damage to the Works or Materials to be incorporated in the Works between the Start Date and the end of the Defects Correction periods shall be remedied by the Contractor at his cost if the loss or damage arises from the Contractor's acts or omissions.

E. Finishing the Contract

42. Completion of Construction and Maintenance

42.1 The Contractor shall request the Engineer to issue a certificate of completion of the construction of the works, and the Engineer will do so upon deciding that the works is completed. This shall be governed as per clause no.8 (g) of Standard General Conditions of Contract.

43. Taking Over

43.1 The Employer shall take over the works within seven days of the Engineer issuing a certificate of completion of works. The Contractor shall continue to remain responsible for its routine maintenance during the maintenance period if specified in the contract.

44. Final Account

Final joint measurement along with the representatives of the contractor should be taken recorded and signed by the Contractors. Contractors should submit the final bill within 1 month of physical completion of the work.

If the contractor fails to submit the final bill within 1 month, the MCGM staff will prepare the final bill based on the joint measurement within next 3 months.

Engineer's decision shall be final in respect of claims for defect and pending claims against contractors.

No further claims should be made by the Contractor after submission of the final bill and these shall be deemed to have been waived and extinguished. Payment of those items of the bills in respect of which there is no dispute and of items in dispute, for quantities and rates as approved by the Commissioner shall be made within a reasonable period as may be necessary for the purpose of verification etc.

After payment of the final bill as aforesaid has been made, the contractor may, if he so desires, reconsider his position in respect of a disputed portion of the final bills and if he fails to do so within 84 days, his disputed claim shall be dealt with as provided in the contract.

A percentage of the retention money, over and above the actual retention money as indicated below shall be held back from payments till the finalization of final bill to be submitted as per above and will be paid within 30 days of acceptance of the final bill.

Sr.no.	Amount of Contract Cost	Minimum Payable Amount in final bill
1	Upto Rs.5 Crs.	Rs.10 Lacs or final bill whichever is more
2	Upto Rs.25 Crs.	Rs.1 Crore or final bill amount whichever is more
3	Upto Rs. 50 Crs.	Rs.2 Crores or final bill amount whichever is more
4	Upto Rs.100 Crs.	Rs.4 Crore or final bill amount whichever is

		more
5	More than Rs.100 Crs..	Rs.7 Crore or final bill amount whichever is more

The contractor have to submit the bill for the work carried out within 15 days from the date of completion of the work to the respective executing department. If the contractor fails to submit their bills to concerned executing department, penalty or action as shown below will be taken for each delayed bill:-

After 15 days from the date of completion/running bill upto certain date, upto next 15 days i.e. upto 30 days	Equal to 5% of bill amount
Next 15 days upto 45 days from the date of completion/running bill upto specified date	Equal to 10% of bill amount
If not submitted within 45 days from the date of completion/ R.A. bill	Bill will not be admitted for payment.

45. Operating and Maintenance Manuals

- 45.1 If "as built" Drawings and/or operating and maintenance manuals are required, the Contractor shall supply them by the dates stated in the Contract Data.
- 45.2 If the Contractor does not supply the Drawings and/or manuals by the dates stated in the Contract Data, or they do not receive the Engineer's approval, the Engineer shall withhold the amount stated in the Contract Data from payments due to the Contractor.

46. Termination

- 46.1 The Employer or the Contractor may terminate the Contract if the other party causes a fundamental breach of the Contract.
- 46.2 Fundamental breaches of Contract shall include, but shall not be limited to, the following:
- a) The Contractor stops work for 30 days when no stoppage of work is shown on the current Programme and the stoppage has not been authorized by the Engineer;
 - b) the Contractor is declared as bankrupt or goes into liquidation other than for approved reconstruction or amalgamation;
 - c) the Engineer gives Notice that failure to correct a particular Defect is a fundamental breach of Contract and the Contractor fails to correct it within a reasonable period of time determined by the Engineer;
 - d) the Contractor does not maintain a Security, which is required;

- e) the Contractor has delayed the completion of the Works by the number of days for which the maximum amount of liquidated damages can be paid, as defined in relevant clause.
- f) the Contractor fails to provide insurance cover as required under relevant clause .
- g) if the Contractor, in the judgment of the Employer, has engaged in the corrupt or fraudulent practices as defined in GCC in competing for or in executing the Contract.
- h) if the Contractor fails to set up a field laboratory with the prescribed equipment, within the period specified in the Contract Data; and
- i) any other fundamental breaches as specified in the Contract Data.
- j) if the Contractor fails to deploy machinery and equipment or personnel as specified in the Contract Data at the appropriate time.

46.3 When either party to the contract gives notice of a breach of contract to the Engineer for a cause other than those listed above, the Engineer shall decide whether the breach is fundamental or not.

46.4 Notwithstanding the above, the Employer may terminate the Contract for convenience.

46.5 If the Contract is terminated, the Contractor shall stop work immediately, make the Site safe and secure, and leave the Site as soon as reasonably possible.

47. Payment upon Termination

47.1 If the Contract is terminated because of a fundamental breach of Contract by the Contractor, the Engineer shall issue a certificate for value of the work done and materials ordered less liquidated damages, if any, less advance payments received up to the date of the issue of the certificate and less the percentage to apply to the value of the work not completed, as indicated in the Contract Data. If the total amount due to the Employer exceeds any payment due to the Contractor, the difference shall be recovered from the security deposit, and performance security. If any amount is still left un-recovered it will be a debt due from the Contractor to the Employer

47.2 If the Contract is terminated at the Employer's convenience, the Engineer shall issue a certificate for the value of the work done, the reasonable cost of removal of Equipment, repatriation of the Contractor's personnel employed solely on the Works, and the Contractor's costs of protecting and securing the Works and less advance payments received up to the date of the certificate, less other recoveries due in terms of the Contract, and less taxes due to be deducted at source as per applicable law.

48. Property

48.1 All Materials on the Site, Plant, Equipment, Temporary Works, and Works shall be deemed to be the property of the Employer for use for completing balance construction work if the Contract is terminated because of the Contractor's default, till the Works is completed after which it will be transferred to the Contractor and credit, if any, given for its use.

49. Release from Performance

If the Contract is frustrated by the outbreak of war or by any other event entirely outside the control of the Employer or the Contractor, the Engineer shall certify that the Contract has been frustrated. The Contractor shall make the Site safe and stop work as quickly as possible after receiving this certificate and shall be paid for all work carried out before receiving it and for any work carried out afterwards to which a commitment was made.

A) Other Conditions of Contract

50. Labour

50.1 The Contractor shall, unless otherwise provided in the Contract, make his own arrangements for the engagement of all staff and labour, local or other, and for their payment, housing, feeding and transport.

50.2 The Contractor shall, if required by the Engineer, deliver to the Engineer a return in detail, in such form and at such intervals as the Engineer may prescribe, showing the staff and the number of the several classes of labour from time to time employed by the Contractor on the Site and such other information as the Engineer may require.

51. Compliance with Labour Regulations

(a) During continuance of the Contract, the Contractor and his sub-Contractors shall abide at all times by all existing labour enactments and rules made there under, regulations, notifications and bye laws of the State or Central Government or local authority and any other labour law (including rules), regulations, bye laws that may be passed or notification that may be issued under any labour law in future either by the State or the Central Government or the local authority.

(b) Furthermore, the Contractor shall keep the Employer indemnified in case any action is taken against the Employer by the competent authority on account of contravention of any of the provisions of any Act or rules made there under, regulations or notifications including amendments. If the Employer is caused to pay or reimburse, such amounts as

may be necessary to cause or observe, or for non-observance of the provisions stipulated in the notifications/bye laws/Acts/Rules/regulations including amendments, if any, on the part of the Contractor, the Engineer/Employer shall have the right to deduct any money due to the Contractor including his amount of performance guarantee. The Employer/Engineer shall also have right to recover from the Contractor any sum required or estimated to be required for making good the loss or damage suffered by the Employer.

(c) The Contractor shall require his employees to obey all applicable laws, including those concerning safety at work.

(d) The employees of the Contractor and the Sub-Contractor in no case shall be treated as the employees of the Employer at any point of time.

52. Drawings and Photographs of the Works

52.1 The Contractor shall do photography/video photography of the site firstly before the start of the work, secondly mid-way in the execution of different stages of work as required by Engineer In-charge and lastly after the completion of the work. No separate payment will be made to the Contractor for this.

52.2 The Contractor shall not disclose details of Drawings furnished to him and works on which he is engaged without the prior approval of the Engineer in writing. No photograph of the works or any part thereof or plant employed thereon, except those permitted under above clause, shall be taken or permitted by the Contractor to be taken by any of his employees or any employees of his sub-Contractors without the prior approval of the Engineer in writing. No photographs/ Video photography shall be published or otherwise circulated without the approval of the Engineer in writing.

53. The Apprentices Act, 1961

The Contractor shall duly comply with the provisions of the Apprentices Act 1961 (III of 1961), the rules made there under and the orders that may be issued from time to time under the said Act and the said Rules and on his failure or neglect to do so, he shall be subject to all liabilities and penalties provided by the said Act and said Rules.

54 Contract Document

The documents forming the contract are to be taken as mutually explanatory of one another. Unless otherwise provided in the contract, the priority of the documents forming the contract shall be, as follows:

- 1) Contract Agreement (if completed)

- 2) The letter of Acceptance
- 3) The Bid:
- 4) Addendum to Bid; if any
- 5) Tender Document
- 6) The Bill of Quantities:
- 7) The Specification:
- 8) Detailed Engineering Drawings
- 9) Standard General Conditions of Contracts (GCC)
- 10) All correspondence documents between bidder/contractor and MCGM.

55 Conflict of Interest

The Applicant shall not have a conflict of interest (the “Conflict of Interest”) that affects the Bidding Process. Any Applicant found to have a Conflict of Interest shall be disqualified. An Applicant shall be deemed to have a Conflict of Interest affecting the Bidding Process, if

1. A constituent of such Applicant is also a constituent of another Applicant; or
2. Such Applicant has the same legal representative for purposes of this Application as any other Applicant; or
3. Such Applicant, or any Associate thereof has a relationship with another Applicant, or any Associate thereof, directly or through common third party/ parties, that puts either or both of them in a position to have access to each other’s information about, or to influence the Application of either or each other; or
4. The Applicant shall be liable for disqualification if any legal, financial or technical adviser of the Authority in relation to the Project is engaged by the Applicant, its Member or any Associate thereof, as the case may be, in any manner for matters related to or incidental to the Project. For the avoidance of doubt, this disqualification shall not apply where such adviser was engaged by the Applicant, its Member or Associate in the past but its assignment expired or was terminated 6 (six) months prior to the date of issue of this TENDER. Nor will this disqualification apply where such adviser is engaged after a period of 3 (three) years from the date of commercial operation of the Project.

56. Applications and costs thereof

No Applicant shall submit more than one Application for the Project. An applicant

applying individually shall not be entitled to submit another application either individually. The Applicant shall be responsible for all of the costs associated with the preparation of their Applications and their participation in the Bid Process. The Authority will not be responsible or in any way liable for such costs, regardless of the conduct or outcome of the Bidding Process.

57. Acknowledgment by Applicant

It shall be deemed that by submitting the Application, the Applicant has:

- a. made a complete and careful examination of the tender;
- b. received all relevant information requested from the Authority;
- c. accepted the risk of inadequacy, error or mistake in the information provided in the tender or furnished by or on behalf of the Authority relating to any of the matters referred; and
- d. Agreed to be bound by the undertakings provided by it under and in terms hereof.

“The Authority” shall not be liable for any omission, mistake or error in respect of any of the above or on account of any matter or thing arising out of or concerning or relating to the TENDER or the Bidding Process, including any error or mistake therein or in any information or data given by the Authority.

58. Right to accept or reject any or all Applications/ Bids

Notwithstanding anything contained in this TENDER, “The Authority” reserves the right to accept or reject any Application and to annul the Bidding Process and reject all Applications/ Bids, at any time without any liability or any obligation for such acceptance, rejection or annulment, and without assigning any reasons therefore. In the event that the Authority rejects or annuls all the Bids, it may, in its discretion, invite all eligible Bidders to submit fresh Bids hereunder.

“The Authority” reserves the right to reject any Application and/ or Bid if:

- (a) at any time, a material misrepresentation is made or uncovered, or
- (b) the Applicant does not provide, within the time specified by the Authority, the supplemental information sought by the Authority for evaluation of the Application.

In case it is found during the evaluation or at any time before signing of the Agreement or after its execution and during the period of subsistence thereof including the concession thereby granted by “The Authority”, that one or more of the pre-qualification conditions have not been met by the Applicant, or the Applicant has made material misrepresentation

or has given any materially incorrect or false information, the Applicant shall be disqualified forthwith if not yet appointed as the Successful Bidder either by issue of the LOA (Letter of Approval) or entering into of the Agreement, and if the Applicant has already been issued the LOA or has entered into the Concession Agreement, as the case may be, the same shall, notwithstanding anything to the contrary contained therein or in this TENDER, be liable to be terminated, by a communication in writing by “The Authority” to the Applicant, without the Authority being liable in any manner whatsoever to the Applicant and without prejudice to any other right or remedy which the Authority may have under this TENDER, the Bidding Documents, the Concession Agreement or under applicable law.

“The Authority” reserves the right to verify all statements, information and documents submitted by the Applicant in response to the TENDER. Any such verification or lack of such verification by the Authority shall not relieve the Applicant of its obligations or liabilities hereunder nor will it affect any rights of the Authority there under.

59 The bid shall be rejected if the bidder-

- a. Stipulates the validity period less than 180 days.
- b. Stipulates own condition/conditions.
- c. Does not fill and (digital) sign undertaking forms, which are incorporated, in the document.

60 Clarifications

Applicants requiring any clarification on the tender may notify “the Authority” in writing or by fax or e-mail. They should send in their queries before the date specified in the header data. “The Authority” shall Endeavor to respond to the queries within the period specified therein. The responses will be sent by fax and/or e-mail. The Authority will forward all the queries and its responses thereto, to all purchasers of the TENDER without identifying the source of queries.

“The Authority” shall Endeavor to respond to the questions raised or clarifications sought by the Applicants. However, the Authority reserves the right not to respond to any question or provide any clarification, in its sole discretion, and nothing in this Clause shall be taken or read as compelling or requiring the Authority to respond to any question or to provide any clarification, but not later than the date provided in header data.

“The Authority” may also on its own motion, if deemed necessary, issue interpretations and clarifications to all Applicants. All clarifications and interpretations issued by the Authority shall be deemed to be part of the tender. Verbal clarifications and information

given by Authority or its employees or representatives shall not in any way or manner be binding on the Authority.

61 Amendment of tender

At any time prior to the deadline for submission of Application, the Authority may, for any reason, whether at its own initiative or in response to clarifications requested by an Applicant, modify the tender by the issuance of Addendum.

Any Addendum thus issued will be sent in writing/ Fax/ Email to all those who have purchased the tender.

In order to afford the Applicants a reasonable time for taking an Addendum into account, or for any other reason, the Authority may, in its sole discretion, extend the Application Due Date.

Preparation and Submission of Application

62 Language

The Application and all related correspondence and documents in relation to the Bidding Process shall be in English language. Supporting documents and printed literature furnished by the Applicant with the Application may be in any other language provided that they are accompanied by translations of all the pertinent passages in the English language, duly authenticated and certified by the Applicant. Supporting materials, which are not translated into English, may not be considered. For the purpose of interpretation and evaluation of the Application, the English language translation shall prevail.

63 Format and signing of Application

The Applicant shall provide all the information sought under this TENDER. The Authority will evaluate only those Applications that are received in the required formats and complete in all respects. Incomplete and /or conditional Applications shall be liable to rejection.

The Applicant will upload bid in One Folder in electronic form which shall contain the scanned certified copies of the documents given below and the documents uploaded has to be digitally signed by the bidder. These copies shall be certified by Practicing Notary approved by the Govt. of Maharashtra or Govt. of India with his stamp, clearly stating his name & registration number, except where original documents are demanded

64 Marking of Applications

The Applicant shall submit the Application in the format specified at Appendix-I, together with the documents, upload in folder as “VENDOR” together with their respective enclosures

Applications submitted by fax, telex, telegram shall not be entertained and shall be rejected outright.

65 Late Applications

Applications received by the Authority after the specified time on the Application Due Date shall not be eligible for consideration and shall be summarily rejected.

66 Confidentiality

Information relating to the examination, clarification, evaluation, and recommendation for the short-listed qualified Applicants shall not be disclosed to any person who is not officially concerned with the process or is not a retained professional advisor advising the Authority in relation to or matters arising out of, or concerning the Bidding Process. The Authority will treat all information, submitted as part of Application, in confidence and will require all those who have access to such material to treat the same in confidence. The Authority may not divulge any such information unless it is directed to do so by any statutory entity that has the power under law to require its disclosure or is to enforce or assert any right or privilege of the statutory entity and/ or the Authority or as may be required by law or in connection with any legal process.

67 Clarification Of Financial Bids

To assist in the examination, evaluation and comparison of Bids, the Engineer may, at his discretion, ask any bidder for clarification of his Bid, including breakdown of unit rates. The request for clarification and the response shall be in writing or by post/facsimile/e-mail. No Bidder shall contact the Engineer on any matter relating to his bid from the time of the bid opening to the time the contract is awarded. Any effort by the Bidder to influence the Engineer in the Engineer's bid evaluation, bid comparison or contract award decisions may result in the rejection of the Bidder's bid.

68 Inspection of site and sufficiency of tender:

1. The Contractor shall inspect and examine the site and its surrounding and shall satisfy himself before submitting his tender as to the nature of the ground and subsoil (so far as is practicable), the form and nature of the site, the quantities and nature of the work and materials necessary for the completion of the works and means of access to the site, the accommodation he may require and in general shall himself obtain all necessary information as to risk, contingencies and other circumstances which may influence or affect his tender. He shall also take into consideration the hydrological and climatic conditions.

2. The Employer may make available to the Contractor data on hydrological and sub-surface conditions as obtained by or on his behalf from investigations relevant to the works but the Contractor shall be responsible for his own interpretation thereof. The contractor shall engage his investigating agency with prior approval of the Engineer from the approved list of such agencies by MCGM or Govt at his cost initially before commencing actual work and which shall be reimbursed immediately subject to satisfaction of the Engineer for faithful compliance and submission of required data regarding such investigation within specified time.

3. The Contractor shall be deemed to have satisfied himself before tendering as to the correctness and sufficiency of his tender for the works and of the rates and prices quoted in the schedule of works / items / quantities, or in Bill of Quantities, which rates and prices shall, except as otherwise provided cover all his obligations under the Contract and all matters and things necessary for proper completion and maintenance of the works. No extra charges consequent on any misunderstanding.

4. **Not Foreseeable Physical Obstructions or Conditions:** If, however, during the execution of the Works the Contractor encounters physical obstructions or physical conditions, other than climatic conditions on the Site, which obstructions or conditions were, in his opinion, not foreseeable by an experienced contractor, the Contractor shall forthwith give notice thereof to the Engineer. On receipt of such notice, the Engineer shall, if in his opinion such obstructions or conditions could not have been reasonably foreseen by an experienced contractor, after due consultation with the Contractor, determine:

- any extension of time to which the Contractor is entitled and
- The amount of any costs which may have been incurred by the Contractor by reason of such obstructions or conditions having been encountered, which shall be added to the Contract Price.
- and shall notify the Contractor accordingly. Such determination shall take account of any instruction which the Engineer may issue to the Contractor in connection therewith, and any proper and reasonable measures acceptable to the Engineer which the Contractor may take in the absence of specific instructions from the Engineer. However such costing shall be got approved by the competent authority as governed vide rules prevailing with authority.

-

5. Office for the Engineer (Works costing upto Rs.50 Lakhs)

The Contractor shall at his own cost and to satisfaction of the Engineer provide a small temporary office, at the work-site which will include tables, chairs and lockers for keeping the records. He shall also make necessary arrangements for drinking water, telephone with a pre-requisite of e-governance and electronic communication. These offices are not to be allowed on public roads without the written instruction of the Engineer. These offices should be preferably located within 50 to 500 m of the worksite. In case the office is more than 500m away from the worksite, the contractor is to provide conveyance for Municipal Staff.

6. Office for the Engineer (Works costing above Rs.50 lakhs)

The Contractor shall at his own cost and to satisfaction of the Engineer provide a temporary office at the work-site which will include tables, chairs and lockers for keeping the records. He shall also make necessary arrangements for drinking water, latrines, with doors, windows, locks, bolts and fastenings sufficient for security for the Engineer, and his subordinates, as close to the works from time to time in progress as can be conveniently arranged, and shall at his own cost furnish the office with such chairs, tables, lockers, locks and fastenings as may be required by the Engineer, and no expense of any kind in connection with the erection or upkeep of the offices or fittings shall be borne by the Corporation, but all such work shall be carried out by the Contractor and the expenses thereof defrayed by him. The Contractor shall also make water connections and fit up stand pipe with a bib tap at each office. The latrines and the water connections shall be subject to all the conditions herein elsewhere laid down for temporary water connection and latrines generally with all requisite equipments for e-governance and electronic and digital communication. These offices are not to be allowed on public roads without the written instruction of the Engineer. These offices should be preferably located within 50 to 500 m of the worksite. In case the office is more than 500m away from the worksite, the contractor is to provide conveyance. Also, for staff working beyond working hours the contractor has to provide conveyance.

7. Permission for provision and removal of office on completion of work: The tenderer shall obtain permission for provision of site office, cement go-down, store, etc. on payment of necessary cost implication. The cement go-down, Watchman cabins, etc. shall be provided as directed and shall be removed by the Tenderers on completion of the work at their cost. It is binding on the Tenderer to fulfill requirements of Environmental

Authorities. The location of such office shall be finalized and got approved from the Engineer before erection/commencement work.

8. **Contractor's office near works:** The Contractor shall have an office near the works at which notice from the Commissioner or the Engineer may be served and shall, between the hours of sunrise and sunset on all working days, have a clerk or some other authorized person always present at such office upon whom such notices may be served and service of any notices left with such clerk or other authorized person or at such office shall be deemed good service upon the Contractor and such offices shall have pre-requisite facilities for e-governance.

69 Official Secrecy:

The Contractor shall of all the persons employed in any works in connection with the contract that the India Official Secrets Act 1923 (XIX of 1923) applies to them and will continue to apply even after execution of the said works and they will not disclose any information regarding this contract to any third party. The contractor shall also bring into notice that, any information found to be leaked out or disclosed the concern person as well as the Contractor will be liable for penal action; further the Corporation will be at liberty to terminate the contract without notice.

70 Subsequent Legislation:

If on the day of submission of bids for the contract, there occur changes to any National or State statute, Ordinance, decree or other law or any regulation or By-laws or any local or other duly constituted authority or the introduction of any such National or State Statute, Ordinance, decree or by which causes additional or reduced cost to the Contractor, such additional or reduced cost shall, after due consultation with the Contractor, be determined by the concerned Engineering Department of MCGM and shall be added to or deducted from the Contract Price with prior approval of competent authority and the concerned Engineering Department shall notify the Contractor accordingly with a copy to the Employer. MCGM reserve the right to take decision in respect of addition/reduction of cost in contract.

71 Patent, Right and Royalties:

The contractor shall save harmless and indemnify the Corporation from and against all claims and proceedings for or on account of infringement of any Patent rights, design trademark or name of other protected rights in respect of any constructional plant, machine work, or material used for or in connection with the Works or any of them and from and

against all claims, proceedings, damages, costs, charges and expenses whatsoever in respect thereof or in relation thereto. Except where otherwise specified, the contractor shall pay all tonnage and other royalties, rent and other payments or compensation, if any, for getting stone, sand, gravel, clay or other materials required for the works or any of them.

72 Payments, Tax and Claims:

- **The limit for unforeseen claims**

Under no circumstances whatever the contractor shall be entitled to any compensation from MCGM on any account unless the contractor shall have submitted a claim in writing to the Eng-in-change within 1 month of the case of such claim occurring.

- **No interest for delayed payments due to disputes, etc:**

It is agreed that the Municipal Corporation of Greater Mumbai or its Engineer or Officer shall not be liable to pay any interest or damage with respect of any moneys or balance which may be in its or its Engineer's or officer's hands owing to any dispute or difference or claim or misunderstanding between the Municipal Corporation of Greater Bombay or its Engineer or Officer on the one hand and the contractor on the other, or with respect to any delay on the part of the Municipal Corporation of Greater Bombay or its Engineer or Officers in making periodical or final payments or in any other respect whatever.

73 Settlement of Disputes:

- **Termination of contract for death**

If the Contractor is an individual or a proprietary concern and the individual or the proprietor dies and if the Contractor is a partnership concern and one of the legal representative of the individual Contractor or the proprietor of the proprietary concern and in case of partnership, the surviving partners, are capable of carrying out and completing the contract, the Commissioner shall be entitled to cancel the contract as to its uncompleted part without the Corporation being in any way liable to payment of any compensation to the estate of the deceased Contractor and or to the surviving partners of the Contractor's firm on account of the cancellation of the contract. The decision of the Commissioner that the legal representative of the deceased Contractor or surviving partners of the Contractor's firm cannot carry out and complete the contract shall be final and binding on the parties. In the event of such cancellation the Commissioner shall not hold estate of the deceased Contractor and or surviving partners of the Contractor's firm liable in damages for not completing the contract.

- **Settlement of Disputes:**

If any dispute or differences of any kind whatsoever other than those in respect of which, the decision of any person is, by the Contract, expressed to be final and binding) shall arise between the Employer and the Contractor or the Engineer and the Contractor in connection with or arising out of the Contract or carrying out of the Works (Whether during the progress of the Works or after their completion and whether before or after the termination, abandonment or breach of the Contract) it, the aggrieved party may refer such dispute within a period of 7 days to the concerned Addl. Municipal Commissioner who shall constitute a committee comprising of three officers i.e. concerned Deputy Municipal Commissioner or Director (ES&P), Chief Engineer other than the Engineer of the Contract and concerned Chief Accountant. The Committee shall give decision in writing within 60 days. Appeal on the Order of the Committee may be referred to the Municipal Commissioner within 7 days. Thereafter the Municipal Commissioner shall constitute a Committee comprising of three Addl. Municipal Commissioners including Addl. Municipal Commissioner in charge of Finance Department. The Municipal Commissioner within a period of 90 days after being requested to do so shall give written notice of committee's decision to the Contractor. Save as herein provided such decision in respect of every matter so referred shall be final and binding upon both parties until the completion of the works, and shall forthwith be given effect to by the Contractor who shall proceed with the works with due diligence, whether he requires arbitration as hereinafter provided or not. If the Commissioner has given written notice of the decision to the Contractor and no Claim to arbitration has been communicated within a period of 90 days from receipt of such notice the said decision shall remain final and binding upon the Contractor.

74 Arbitration and Jurisdiction:

If the Commissioner shall fail to give notice of the decision as aforesaid within a period of 90 days after being requested as aforesaid, or if the Contractor be dissatisfied with any such decision, then and in any such case the Contractor may within 90 days after receiving notice of such decision or within 90 days after the expirations of the first named period of 90 days (as the case may be) require that the matter or matters in dispute be referred to arbitration as hereinafter provided. All disputes or differences in respect of which the decision (if any) of the Commissioner has not become final and binding as aforesaid shall be finally settled by

Arbitration as follows:

Arbitration shall be effected by a single arbitrator agreed upon the parties. The arbitration shall be conducted in accordance with the provisions of the Arbitration Act, 1996 or any statutory modifications thereof, and shall be held at such place and time within the limits of Brihan Mumbai as the arbitrator may determine. The decision of the arbitrator shall be final and binding upon the parties hereto and the expense of the arbitration shall be paid as may be determined by the arbitrator. Performance under the Contract shall, if reasonably be possible, continued during the arbitration proceedings and payment due to the Contractor by the Employer shall not be withheld unless they are the subject matter of arbitration proceedings. The said arbitrator shall have full power to open up, review and revise any decision, opinion, direction, certification or valuation of the Commissioner and neither party shall be limited in the proceedings before such arbitrator to the evidence or arguments put before the Commissioner for the purpose of obtaining his said decision. No decision given by the Commissioner in accordance with the foregoing provisions shall disqualify him from being called as a witness and giving evidence before the arbitrator on any matters whatsoever relevant to the disputes or difference referred to the arbitrator as aforesaid. All awards shall be in writing and for claims equivalent to 5,00,000 or more such awards shall state reasons for amounts awarded. The expenditure of arbitration shall be paid as may be determined by arbitrator.

In case of any claim, dispute or difference arising in respect of a contract, the cause of action thereof shall be deemed to have arisen in Mumbai and all legal proceedings in respect of any claim, dispute or difference shall be instituted in a competent court in the City of Mumbai only.

75 Copyright:

The copyright of all drawings and other documents provided by the Contractor under the contract shall remain vested in the Contractor or his sub-contractors as the case may be the employer shall have a license to use such drawings and other documents in connection with the design, construction, operation, maintenance of the works. At any time the Employer shall have further license without additional payment to the Contractor to use any such drawings or documents for the purpose of making any improvement of the works or enlargement or duplication of any part thereof, provided that such improvement, enlargement, or duplication by itself or in conjunction with any other improvements, enlargements or duplications already made in accordance with the further license does not result in the duplication of the whole works.

76. Receipts to be signed in firm's name by any one of the partners:

Every receipt for money which may become payable or for any security which may become transferable to the Contractor under these present shall, if signed in the partnership name by any one of the partners, be a good and sufficient discharge to the Commissioner and Municipal Corporation in respect of the money or security purporting to be acknowledged thereby, and in the event of death of any of the partners during the pendency of this contract, it is hereby expressly agreed that every receipt by any one of the surviving partners shall, if so signed as aforesaid, be good and sufficient discharge as aforesaid provided that nothing in this clause contained shall be deemed to prejudice or effect any claim which the Commissioner or the Corporation may hereafter have against the legal representatives of any partners so dying or in respect of any breach of any of the conditions thereof, provided also that nothing in this clause contained shall be deemed prejudicial or affect the respective rights or obligations of the Contractors and of the legal representatives of any deceased Contractors interest.

77 Proprietary data

All documents and other information supplied by the Authority or submitted by an Applicant to the Authority shall remain or become the property of the Authority. Applicants are to treat all information as strictly confidential and shall not use it for any purpose other than for preparation and submission of their Application. The Authority will not return any Application or any information provided along therewith.

78 Correspondence with the Applicant

Save and except as provided in this TENDER, the Authority shall not entertain any correspondence with any Applicant in relation to the acceptance or rejection of any Application.

79 Price Variation Clause

The Contractor shall be reimbursed or shall refund to the Corporation as he case may be the variation in the value of the work carried out from time to time, depending on whether the prices of material and labour as a whole rise or fall, and the method adopted for such computations shall be as given below, it being clearly understood that the contractor shall have no claim for being reimbursed on the ground that the price of a particular material or group of materials have risen beyond the limits of the presumptions made in the following paras, however, no price variations shall be made applicable for contracts upto 12 months:

- A) Controlled materials: Price variations shall be permitted in respect of these materials the price level of which is controlled by the Government or its agency. The rate ruling on the

date of submission of the tender shall be considered as the basic price of such material for adjustment. Any variation in this rate shall be considered for reimbursement to the contractor or refund to be claimed from the contractor as the case may be. The contractor shall, for the purpose of adjustment submit in original the relevant documents from the suppliers.

B) Labour and other materials: For the purpose of this contract and for allowing reimbursement of refund on account of variation of prices of (i) labour, and (ii) materials other than materials mentioned in A above, computation will be based on the formula enunciated below which is based on the presumptions that :

i) The general price level of labour, rises or falls in proportion to the rise or fall of consumer price index number 9 (general) for working class in Mumbai.

ii) The general price level of materials rises or falls in proportion to rise or fall of whole-sale price index as published by 'Economic Adviser to Govt. of India'.

iii) And that the component of labour is to the extent of 30 percent of 88 percent and the component of materials is to the extent of 70 percent of 88 percent of the value of the work carried out. The remaining 12 percent being the presumptive profit of the contractor.

a) Formula for Labour component:

$$VL = \frac{(0.88 R) \times 30}{100} \times \frac{(I - IO)}{IO}$$

b) Formula for Material component :

$$VM = \frac{(0.88 R \times 70 - C)}{100} \times \frac{(W - WO)}{WO}$$

Where –

VL = Amount of price variation to be reimbursed or claimed as refund on account of general rise or fall of index referred to above.

I = Consumer Price Index number of working class for Mumbai (declared by the Commissioner of Labour and Director of Employment, Mumbai) applicable to the period under reference (base year ending 2004-05 as 100 i.e. new series of indices).

IO = Consumer price index number for working class for Mumbai (declared by the Commissioner of labour and Director of Employment, Mumbai) prevailing, on the day of 28 days prior to the date of submission of the tender.

VM = The amount of price variation to be reimbursed or claimed as refund on account of general rise or fall of wholesale price index for period under reference.

W = Average wholesale price index as published by Economic Adviser to Govt. of India applicable to the period under reference.

WO = Wholesale price index as stated above prevailing on the day of 28 days prior to the date of submission of the tender.

R = Total value of the work done during the period under reference as recorded in the Measurement Book excluding water charges and sewerage charges but including cost of excess in respect of item upto 50 percent

C = Total value of Controlled materials used for the works as recorded in Measurement Book and paid for at original basic rate plus the value of materials used .

- i) The quantity of the Controlled material adopted in working out the value of 'C' shall be inclusive of permitted wastages as / if mentioned in specifications.
- ii) The basic rate for the supply of controlled material shall be inclusive of all the components of cost of materials excluding transport charges incurred for bringing the material from place of delivery to the site.

Computations based on the above formula will be made for the period of each bill separately and reimbursement will be made to (when the result is plus) and refund will be claimed from (when the result is minus) the contractor's next bill. The above formulae will be replaced by the formulae in Annexure-I as and when mentioned in special conditions of contract

The operative period of the contract for application of price variation shall mean the period commencing from the date of commencement of work mentioned in the work order and ending on the date when time allowed for the work order and ending on the date when time allowed for the work specified in the contract for work expires, taking into consideration, the extension of time, if any, for completion of the work granted by Engineer under the relevant clause of the conditions of contract in cases other than those where such extension is necessitated on account of default of the contractor.

The decision of the Engineer as regards the operative period of the contract shall be final and binding on the contractors.

- iii) Where there is no supply of controlled items to contractor the component 'C' shall be taken as zero.
- C) Adjustment after completion: If the Contractor fails to complete the works within the time for completion adjustment of prices thereafter until the date of completion of the works shall be made using either the indices or prices relating to the prescribed time for completion, or the current indices or prices whichever is more favorable to the employer, provided that if an extension of time is granted, the above provision shall apply only to adjustments made after the expiry of such extension of time.
- D) Price variation will be calculated similarly and separately for extra items and / or excess quantities and provisional sums calculated under Sub Clause 10 (b)A (i)&(ii) and Sub Clause 10 (b) B(ii) based on the above formula/formulae in Annexure-I as and when mentioned in Special conditions of contract; IO and WO being the indices applicable to the date on which the rates under Sub Clause 10 (a)A (i)&(ii) and Sub Clause 10 (a) B(iii) are fixed. No price variation shall be admissible for FAIR items created during execution.

80. Maximum Price Variation shall be as follows:

Time Period of Project	Maximum limit of Price Variation
Up to 12 months	No variation allowed
Above 12 months to 24 months	5%
Above 24 months	10%

***Approval of AMC/MC shall be obtained before invitation of tender in case of any changes in above.**

Note: 1) The extension in time period for the projects originally estimated including monsoon results in change of price variation slabs as mentioned above i.e. from first slab to second slab or from second slab to third slab, then the maximum limit of original slab will prevail.

2) Operative period shall mean original or extended time period of contract.

For example:

Extension of Time period	Maximum Price Variation
If original period of 11 months including monsoon extends to 16. The operative period will be 11+5 months.	No variation allowed
If original period of 11 months excluding monsoon extends to 16. The operative period will be 11+5 months.	Maximum 5% variation allowed

Price Variation during Extended Period of Contract:

(i) Extension Due To Modification & Extension for delay due to MCGM :

The price variation for the period of extension granted shall be limited to the amount payable as per the Indices. In case the indices increases or decreases, above/below the indices applicable, to the last month of the original or extended period vide clause 8(1)(a)(i) and (ii) of standard GCC

(ii) Extension Of Time For Delay Due To Contractor :

(a) The price variation for the period of extension granted shall be limited to the amount payable as per the Indices in case the indices increase, above the indices applicable, to the last month of the original completion period or the extended period vide above clause 8(1)(a)(i) and (ii) of standard GCC.

(b) The price variation shall be limited to the amount payable as per the indices, in case the indices decrease or fall below the indices applicable, to the last month of original / extended period of completion period vide above clause 8(1)(b) of standard GCC, then lower indices shall be adopted.

(iii) Extension of Time For Delay due to reasons not attributable to MCGM and Contractor (Reference Cl.8(d) of Standard GCC):

The price variation for the period of extension granted shall be limited to the amount payable as per the Indices in case the indices increases or decreases, above/below the indices applicable, to the last month of the original period.

81. Payment:

Interim Payment:

i) Interim bills shall be submitted by the Contractor from time to time (but at an interval of not less than one month) for the works executed. The Engineer shall arrange to have the bills verified by taking or causing to be taken, where necessary, the requisite measurement of work.

ii) Payment on account for amount admissible shall be made on the Engineer certifying the sum to which the Contractor is considered entitled by way of interim payment for all the work executed, after deducting there from the amount already paid, the security deposit / retention money and such other amounts as may be deductible or recoverable in terms of the contract.

iii) On request, the contractor will be paid upto 75 percent of the value of the work carried out as an adhoc payment in the first week of next month after deducting there from recoveries on account of advances, interest, retention money, income tax etc. The balance payment due will be paid thereafter.

iv) No interim payment will be admitted until such time the Contractor have fully complied with the requirement of the Condition no.8 (g) and 8 (h) concerning submission and approval of Network Schedule for the works, as detailed in Condition 8 (h). A fixed sum shall be held in abeyance at the time of next interim payment for non-attainment of each milestone in the network and shall be released only on attainment of the said milestone.

v) An interim certificate given relating to work done or material delivered may be modified or corrected by a subsequent interim certificate or by the final certificate. No certificate of the Engineer supporting an interim payment shall of itself be conclusive evidence that any work or materials to which it relates is / are in accordance with the contract.

82 Banning/De-Registration of Agencies of Construction works in MCGM

- **The regulations regarding Demotion/ Suspension Banning for specific period or permanently / De-Registration shall be governed as per the respective condition in Contractor Registration Rules of MCGM.**

83. JOINT VENTURE

~~———— In case if Joint Venture is allowed for the Project, the guidelines for JV as follows shall be incorporated in the Tender Document:~~

- ~~a) Joint Venture should be allowed only when the number of identifiable different works is more than one and/or the estimated cost of tender is more than Rs.100 Crores. JV shall also be allowed for complex technical work below Rs.100 Crores with the approval of concerned AMC~~

- ~~b) Separate identity/name shall be given to the Joint Venture firm.~~
- ~~e) Number of members in a JV firm shall not be more than three in normal circumstances, if the work involves only one discipline (say Civil or Electrical). If number of members in JV is required to be more than three, then approval of concerned AMC needs to be sought.~~
- ~~d) A member of JV firm shall not be permitted to participate either in individual capacity or as a member of another JV firm in the same tender.~~
- ~~e) The tender form shall be purchased and submitted in the 'name of the JV firm or any constituent member of the JV.~~
- ~~f) Normally EMD shall be submitted only in the name of the JV and not in the name of constituent member. However, EMD in the name of lead partner can be accepted subject to submission of specific request letter from lead partner stating the reasons for not submitting the EMD in the name of JV and giving written confirmation from the JV partners to the effect that the EMD submitted by the lead partner may be deemed as EMD submitted by JV firm.~~
- ~~g) One of the members of the JV firm shall be the lead member of the JV firm who shall have a majority (at least 51%) share of interest in the JV firm. The other members shall have a share of not less than 20% each in case of JV firms with up to three members and not less than 10% each in case of JV firms with more than three members. In case of JV firm with foreign member(s), the lead member has to be an Indian firm with a minimum share of 51%.~~
- ~~h) A copy of Letter of Intent or Memorandum of Understanding (MoU) executed by the JV members shall be submitted by the JV firm along with the tender. The complete details of the members of the JV firm, their share and responsibility in the JV firm etc. particularly with reference to financial technical and other obligation shall be furnished in the agreement.~~
- ~~i) Once the tender is submitted, the agreement shall not be modified/altered/terminated during the validity of the tender. In case the tenderer fails to observe/comply with this stipulation, the full Earnest Money Deposit (EMD) shall be forfeited. In case of successful tenderer, the validity of this agreement shall be extended till the currency of the contract expires.~~
- ~~j) Approval for change of constitution of JV firm shall be at the sole discretion of the MCGM. The constitution of the JV firm shall not be allowed to be modified after submission of the tender bid by the JV firm except when modification becomes inevitable due to succession laws etc. and in any case the minimum eligibility criteria should not get vitiated. In any case the Lead Member should continue to be the Lead Member of the JV firm. Failure to observe this requirement would render the offer invalid.~~
- ~~k) Similarly, after the contract is awarded, the constitution of JV firm shall not be allowed to be altered during the currency of contract except when modification become inevitable due to succession laws etc. and in any case the minimum eligibility criteria should not get vitiated. Failure to observe this stipulation shall be deemed to be breach of contract with all consequential penal action as per contract condition.~~
- ~~l) On award of contract to a JV firm, a single Performance Guarantee shall be required to be submitted by the JV firm as per tender conditions. All the Guarantees like Performance Guarantee, Bank Guarantee for Mobilization advance, machinery Advance etc. shall be accepted only in the name of the JV firm and no splitting of guarantees amongst the members of the JV firm shall be permitted.~~

~~m) On issue of LOA, an agreement among the members of the JV firm (to whom the work has been awarded) has to be executed and got registered before the Registrar of the Companies under Companies Act or before the Registrar / Sub Registrar under the Registration Act, 1908. This agreement shall be submitted by the JV firm to the MCGM before signing the contract agreement for the work. (This agreement format should invariably be part of the tender condition). In case the tenderer fails to observe/comply with this stipulation, the full Earnest Money Deposit (EMD) shall be forfeited and other penal actions due shall be taken against partners of the JV and the JV. This joint venture agreement shall have, inter alia, following clauses:-~~

- ~~i. **Joint and several liability** — The members of the JV firm to which the contract is awarded, shall be jointly and severally liable to the Employer (MCGM) for execution of the project in accordance with General and Special conditions of the contract. The JV members shall also be liable jointly and severally for the loss, damages caused to the MCGM during the course of execution of the contract or due to non-execution of the contract or part thereof.~~
- ~~ii. **Duration of the Joint Venture Agreement** — It shall be valid during the entire period of the contract including the period of extension if any and the maintenance period after the work is completed.~~
- ~~iii. **Governing Laws** — The Joint Venture Agreement shall in all respect be governed by and interpreted in accordance with Indian Laws.~~
- ~~iv. **Authorized Member** — Joint Venture members shall authorize one of the members on behalf of the Joint Venture firm to deal with the tender, sign the agreement or enter into contract in respect of the said tender, to receive payment, to witness joint measurement of work done, to sign measurement books and similar such action in respect of the said tender/contract. All notices/correspondences with respect to the contract would be sent only to this authorized member of the JV firm.~~

~~No member of the Joint Venture firm shall have the right to assign or transfer the interest right or liability in the contract without the written consent of the other members and that of the employer in respect of the said tender/contract.~~

~~**n. Documents to be enclosed by the JV firm along with the tender:**~~

- ~~i. — In case one or more of the members of the JV firm is/are partnership firm(s), following documents shall be submitted:
 - ~~a. — Notary certified copy of the Partnership Deed,~~
 - ~~b. — Consent of all the partners to enter into the Joint Venture Agreement on a stamp paper of appropriate value (in original).~~
 - ~~c. — Power of Attorney (duly registered as per prevailing law) in favor of one of the partners — to sign the MOU and JV Agreement on behalf of the partners and create liability against the firm.~~~~
- ~~ii. — In case one or more members is/are Proprietary Firm or HUF, the following documents shall be enclosed:
 - ~~a. — Affidavit on Stamp Paper of appropriate value declaring that his Concern is a Proprietary Concern and he is sole proprietor of the Concern OR he is in position of "KARTA" of Hindu Undivided Family and he has the authority, power and consent given by other partners to act on behalf of HUF.~~~~
- ~~iii. — In case one or more members is/are limited companies, the following documents shall be submitted:~~

- ~~a. Notary certified copy of resolutions of the Directors of the Company, permitting the company to enter into a JV agreement, authorizing MD or one of the Directors or Managers of the Company to sign MOU, JV Agreement, such other documents required to be signed on behalf of the Company and enter into liability against the company and/or do any other act on behalf of the company.~~
- ~~b. Copy of Memorandum and articles of Association of the Company.~~
- ~~e. Power of Attorney (duly registered as per prevailing law) by the Company authorizing the person to do/act mentioned in the para (a) above.~~

~~o. All the members of the JV shall certify that they have not been black listed or debarred by MCGM from participation in tenders/contract in the past either in their individual capacity or the JV firm or partnership firm in which they were members / partners.~~

~~p. Credentials & Qualifying criteria: Technical and financial eligibility of the JV firm shall be adjudged based on satisfactory fulfilment of the following criteria:~~

~~**Technical eligibility criteria:** In case of Work involving single discipline, the Lead member of the JV firm shall meet at least 35% requirement of technical capacity as stipulated in tender document.~~

~~OR~~

~~In case of composite works (e.g. works involving more than one distinct component such as Civil Engineering works, M&E works, Electrical works, etc. and in the case of major bridges, substructure and superstructure etc.), atleast one member should have satisfactorily completed 35% of the value of any one component of the project work so as to cover all the components of project work or any member having satisfactorily completed 35% of the value of work of each component during last seven financial years.~~

~~**In such cases, what constitutes a component in a composite work shall be clearly defined as part of the tender condition without any ambiguity.**~~

~~**Financial eligibility criteria:** The contractual payments received by the JV firm or the arithmetic sum of contractual payments received by all the members of JV firm in any one of the previous three financial years and shall be at least **100% of the estimated value** of the work as mentioned in the tender.~~

84. Compensation for delay:

If the Contractor fails to complete the works and clear the site on or before the Contract or extended date(s) / period(s) of completion, he shall, without prejudice to any other right or remedy of Municipal Corporation on account of such breach, pay as agreed compensation, amount calculated as stipulated below (or such smaller amount as may be fixed by the Engineer) on the contract value of the whole work or on the contract value of the time or group of items of work for which separate period of completion are given in the contract and of which completion is delayed for every week that the whole of the work of item or group of items of work concerned remains uncompleted, even though the contract as a whole be completed by the contract or the extended date of completion. For this purpose the term 'Contract Value' shall be the value of the work at Contract Rates as ordered including the value of all deviations ordered:

- Completion period for projects (originally stipulated or as extended) not exceeding 6 months: **to the extent of maximum 1 percent per week.**
- Completion period for projects (originally stipulated or as extended) exceeding 6 months and not exceeding 2 years: **to the extent of maximum ½ percent per week.**
- Completion period for projects (originally stipulated or as extended) exceeding 2 years : **to the extent of maximum ¼ percent per week.**

When the delay is not a full week or in multiple of a week but involves a fraction of a week the compensation payable for that fraction shall be proportional to the number of days involved.

Provided always that the total amount of compensation for delay to be paid this condition shall not exceed the undernoted percentage of the Contract Value of the item or group of items of work for which a separate period of completion is given.

- i) Completion period (as originally stipulated or as extended) not exceeding 6 months: **10 percent.**
- ii) Completion period (as originally stipulated or as extended) exceeding 6 months and not exceeding 2 years: **7½ percent.**
- iii) Completion period (as originally stipulated or as extended) exceeding 2 years : **5 percent.**

The amount of compensation may be adjusted set off against any sum payable to the contractor under this or any other contract with the Municipal Corporation.

85. Action and Compensation Payable In Case Of Bad Work And Not Done As Per Specifications

All works under or in course of execution or executed in pursuance of the contract, shall at all times be open and accessible to the inspection and supervision of the Engineer-in-charge, his authorized subordinates in charge of the work and all the superior officers, officer of the Vigilance Department of the MCGM or any organization engaged by the MCGM for Quality Assurance and the contractor shall, at all times, during the usual working hours and at all other times at which reasonable notice of the visit of such officers has been given to the contractor, either himself be present to receive orders and instructions or have a responsible agent duly accredited in writing, present for that purpose. Orders given to the Contractor's agent shall be considered to have the same force as if they had been given to the contractor himself.

If it shall appear to the Engineer-in-charge or his authorized subordinates in-charge of the work or to the officer of Vigilance Department, that any work has been executed with unsound, imperfect or unskillful workmanship or with materials of any inferior description, or that any materials or articles provided by him for the execution

of the work are unsound or of a quality inferior to that contracted for or otherwise not in accordance with the contract, the contractor shall, on demand in writing which shall be made within twelve months of the completion of the work from the Engineer-in-Charge specifying the work, materials or articles complained of notwithstanding that the same may have been passed, certified and paid for forthwith rectify, or remove and reconstruct the work so specified in whole or in part, as the case may require or as the case may be, remove the materials or articles so specified and provide other proper and suitable materials or articles at his own charge and cost. In the event of the failing to do so within a period specified by the Engineer-in-Charge in his demand aforesaid, then the contractor shall be liable to pay compensation at the same rate as under clause 8.e. of the general condition of contract in section 9 of tender document (for Compensation for delay) for this default. In such case the Engineer-in Charge may not accept the item of work at the rates applicable under the contract but may accept such items at reduced rates as the Engineer in charge may consider reasonable during the preparation of on account bills or final bill if the item is so acceptable without detriment to the safety and utility of the item and the structure or he may reject the work outright without any payment and/or get it and other connected and incidental items rectified, or removed and re-executed at the risk and cost of the contractor. Decision of the Engineer-in-Charge to be conveyed in writing in respect of the same will be final and binding on the contractor.

If the penalisation amount exceeds maximum limit with respect to Clause 8.e of Standard General Conditions of Contract, then a show cause notice shall necessarily be issued to the contract as to why the contract should not be terminated.

The above clause is summarized to make it easy to understand as follows:

1. The Engineer-in-charge shall issue notice to the contractor for rectifying the defects or redoing of the work if necessary, within specific time to achieve the desired quality and quantity of the work and this should be governed by clause 8.f and 9.b of Standard General Conditions of Contract.
2. If the contractor fails to comply the same, only then, the contractor shall be liable to pay compensation at the same rate as under clause 8.e of the Standard General Condition of Contract (for Compensation for delay) for this default.
3. If the penalization amount exceeds the maximum limit, then the contractor will be liable for being banned/ deregistered from business dealings with MCGM and this shall be governed by relative provision in Registration Rules of MCGM and Standard General Conditions of Contract.
4. This penalization shall be levied only on account of delay in work, unsound, imperfect or unskillful workmanship or with materials of any inferior description, or that any materials or articles provided by him for the execution of the work are unsound or of quality inferior to that contracted for or otherwise not in accordance with the contract.

86. Contractors remain liable to pay compensation:

In any case in which any of the powers conferred upon the Engineer In-charge by the **relevant clauses** in documents that form a part of contract as exercised or is exercisable in the event of any future case of default by the Contractor, he is declared liable to pay compensation amounting to the whole of his security deposit. The liability of the Contractor for past and future compensation shall remain unaffected.

In the event of the Executive Engineer taking action against these **relevant clauses**, he may, if he so desires, take possession of all or any tools and plant, materials and stores in or upon the work of site thereof or belonging to the Contractor or procured by him and intended to be used for the execution of the work or any part thereof paying or allowing for the same in account at the contract rates, or in the case of contract rates not being applicable at current market rates to be certified by the Executive Engineer, may after giving notice in writing to the Contractor or his staff of the work or other authorized agent require him to remove such tools and plants, materials or stores from the premises within a time to be specified in such notice and in the event of the Contractor failing to comply with any such requisition, the Executive Engineer may remove them at the contractors expense of sell them by auction or private sell on account of the Contractor at his risk in all respects and certificate of the Executive Engineer as to the expense of any such removal and the amount of the proceeds an expense of any such sell be final and conclusive against the Contractor.

87. No Claim To Any Payment Or Compensation Or Alteration In Or Restriction Of Work

(a) If at any time after the execution of contract documents, the Engineer shall for any reason whatsoever, desires that the whole or any part of the works specified in the Tender should be suspended for any period or that the whole or part of the work should not be carried out, at all, he shall give to the Contractor a Notice in writing of such desire and upon the receipt of such notice, the Contractor shall forthwith suspend or stop the work wholly or in part as required after having due regard to the appropriate stage at which the work should be stopped or suspended so as not to cause any damage or injury the work already done or endanger the safety thereof, provided that the decision of the Engineer as to the stage at which the work or any part of it could be or could have been safely stopped or suspended shall be final and conclusive against the contractor.

The Contractor shall have no claim to any payment or compensation whatsoever by reason of or in pursuance of any notice as aforesaid, on account of any suspension, stoppage or curtailment except to the extent specified hereinafter.

(b) Where the total suspension of Work Order as aforesaid continued for a continuous period exceeding 90 days the contractor shall be at liberty to withdraw from the contractual obligations under the contract so far as it pertains to the

unexecuted part of the work by giving 10 days prior notice in writing to the Engineer within 30 days of the expiry of the said period of 90 days, of such intention and requiring the Engineering to record the final measurement of the work already done and to pay final bill. Upon giving such Notice, the Contractor shall be deemed to have been discharged from his obligations to complete the remaining unexecuted work under his contract. On receipt of such notice the Engineer shall proceed to complete the measurement and make such payment as may be finally due to the contractor within a period of 90 days from the receipt of such Notice in respect of the work already done by the contractor. Such payment shall not in any manner prejudice the right of the contractor to any further compensation under the remaining provisions of this clause.

(c) Where the Engineer required to Contractor to suspend the work for a period in excess of 30 days at any time or 60 days in the aggregate, the Contractor shall be entitled to apply to the Engineer within 30 days of the resumption of the work after such suspension for payment of compensation to the extent of pecuniary loss suffered by him in respect of working machinery remained ideal on the site of on the account of his having to pay the salary of wages and labour engaged by him during the said period of suspension provided always that the contractor shall not be entitled to any claim in respect of any such working machinery, salary or wages for the first 30 days whether consecutive or in the aggregate or such suspension or in respect of any such suspension whatsoever occasion by unsatisfactory work or any other default on his part, the decision of the Engineer in this regard shall be final and conclusive against the contractor.

88. Contractor to supply plant, ladder, scaffolding, etc and is liable for damages arising from non provision of lights, fencing, etc.

The Contractor shall supply at his own cost all material, plant, tools, appliances, implements, ladders, cordage, tackle scaffolding and temporary works requisite or proper for the proper execution of the work, whether, in the original altered or substituted form and whether included in the specification of other documents forming part of the contract or referred to in these conditions or not and which may be necessary for the purpose of satisfying or complying with the requirements of the Eng-In-Charge as to any matter as to which under these conditions is entitled to be satisfied, or which is entitled to require together with the carriage therefore to and from the work.

The Contractor shall also supply without charge, the requisite number of person with the means and materials necessary for the purpose of setting out works and counting, weighing and assisting in the measurements of examination at any time and from time to time of the work or materials, failing which the same may be provided by the Engineer In-charge at the expense of the contractor and the expenses may be deducted from any money due to the contractor under the contract or from his security deposit or the proceeds of sale thereof, or offers sufficient portion thereof.

The contractor shall provide all necessary fencing and lights required to protect the public from accident and shall also be bound to bear the expenses of defence of every suit, action or other legal proceedings, that may be brought by any person for injury sustained owing to neglect of the above precautions and to pay any damages and cost which may be awarded in any such suit action or proceedings to any such person or which may with the consent of the contractor be paid for compromising any claim by any such person.

89. Prevention of Fire:

The contractor shall not set fire to any standing jungle, trees, brushwood or grass without a written permit from the Engineer In-charge. When such permit is given, and also in all cases when destroying cut or dug up trees brushwood, grass, etc., by fire, the contractor shall take necessary measure to prevent such fire spreading to or otherwise damaging surrounding property. The Contractor shall make his own arrangements for drinking water for the labour employed by him.

90. Compensation for all damages done intentionally or unintentionally by contractor's labour whether in or beyond the limits of MCGM property including any damage caused by spreading the fire shall be estimated by the Engineer In-charge or such other officer as he may appoint and the estimate of the Engineer in-charge to the decision of the Dy. Chief Engineer on appeal shall be final and the contractor shall be bound to pay the amount of the assessed compensation on demand failing which the same will be recovered from the Contractor as damages or deducted by the Engineer In-charge from any sums that may be due or become due from MCGM to contractor under this Contract or otherwise. Contractor shall bear the expenses of defending any action or other legal proceedings that may be brought to prevent the spread of fire and he shall pay any damages and costs that may be awarded by the Court in consequence.

91. In the case of Tender by partners, any change in the constitution of the firm shall be forthwith, notified by the contractor through the Engineer In-charge for his information.

92. Action where no specifications:

In the case of any class of work for which there is no such specifications, such works shall be carried out in accordance with the specifications and in the event of there being no such specifications, then in such case, the work shall be carried out in all respects in accordance with all instructions and requirements of the Engineer In-charge.

93. Safety and medical help:

(i) The Contractor shall be responsible for and shall pay the expenses of providing medical help to any workmen who may suffer a bodily injury as a result of an accident. If such expenses are incurred by MCGM, the same shall be recoverable from the contractor forthwith and be included without prejudice to any other

remedy of MCGM from any amount due or that may become due to the Contractor.

- (ii) The contractor shall provide necessary personal safety equipment and first-aid box for the use of persons employed on the site and shall maintain the same in condition suitable for immediate use at any time.
- (iii) The workers shall be required to use the safety equipments so provided by the contractor and the contractor shall take adequate steps to ensure the proper use of equipments by those concerned.
- (iv) When the work is carried on in proximity to any place where there is risk or drawing all necessary equipments shall be provided and kept ready for use and all necessary steps shall be taken for the prompt rescue of any person in danger.

94. No compensation shall be allowed for any delay caused in the starting of the work on account of acquisition of land or in the case of clearance of works, on account of ant delay in according to sanction of estimates.

95. Anti-malaria and other health measures:

Anti-Malaria and other health measures shall be taken as directed by the Executive Health Officer of MCGM. Contractor shall see that mosquitogenic conditions are created so as to keep vector population to minimum level. Contractor shall carry out anti-malaria measures in the area as per the guidelines issued by the Executive Health Officer of MCGM from time to time.

In case of default, in carrying out prescribed anti-malaria measures resulting in increase in malaria incidence, contractor shall be liable to pay MCGM on anti-malaria measures to control the situation in addition to fine.

SECTION 10
SPECIFICATIONS
& SELECTION OF MATERIAL

10.1 SPECIFICATIONS & SELECTION OF MATERIAL

The tender is prepared on the basis of Unified Schedule of Rates and specifications **2018**. The specifications of the items of USOR are available on MCGM portal <http://portal.mcgm.gov.in> under the Tender tab. Hence the deserving contractor shall either download the same from MCGM portal or the same may be collected in the soft copy format at the time of purchasing the tender from this office.

10.2 SELECTION OF MATERIAL

1. All materials brought on the site of work and meant to be used in the same, shall be the best of their respective kinds and to the approval of the Engineer. The Engineer or his representative will accept that the materials are really the best of their kinds, when it is proved beyond doubt that no better materials of the particular kind in question are available in the market.
2. The contractor shall obtain the approval of the Engineer of samples of all materials to be used in the works and shall deposit these samples with him before placing an order for the materials with the suppliers. The materials brought on the works shall conform in every respect to their approved samples. Fresh samples shall be deposited with the Engineer whenever the type or source of any material changes.
3. The contractor shall check each fresh consignment of materials as it is brought to the site of works to see that they conform in all respects to the Specifications of the samples approved by the Engineer, or both.
4. The Engineer will have the option to have any of the materials tested to find out whether they are in accordance with the Specifications and the Contractor will bear all expenses for such testing. All B bills, vouchers and test certificates, which in the opinion of the Engineer or his representative are necessary to convince him as to the quality of the materials or their suitability shall be produced for his inspection when required.
5. Any materials that have not been found to conform to the specifications will be rejected forthwith and shall be removed from the site by the contractor at his own cost within 24 hours.
6. The Engineer shall have power to cause the Contractors to purchase and use such materials from any particular source, as may in his opinion be necessary for the proper execution of the work.

7. Notwithstanding the source, the sand shall be washed using sand washing machine before use.

8. **10.3 GENERAL NOTES:**

The detailed description, notes, rates and unit of payment of various items mentioned in the BOQ and rate shall be as per Unified schedule of Rates 2018 as amended of the M.C.G.M mentioned below:

Sr.No.	Department	Abbreviation
1	Building Works/ Common Schedule	CS
2	Roads	RW
3	Traffic and Signalling	RT
4	Bridges	BW
5	Water Supply Projects	WSP
6	Hydraulic Engg.	HE
7	Sewerage Projects	SP
8	Storm Water Drains	SWD
9	Mechanical and Electrical	ME
10	Garden Works	GW

10.4 MILD STEEL PIPE FABRICATION WORK SPECIFICATIONS

Fabrication of Pipes and specials detailed specifications

F-1 Scope of Specifications: These specifications shall cover the work of:

- 1) Procuring of M.S plates, cut plates etc of required size and thickness and other MS structural steel such as channels ,angles ,flats ,nut bolts etc as per relevant B.I.S specifications for fabrication of pipes and specials and transporting these material s to the contractor's approved/ nominated sub contractor's factory for fabrication of pipes, specials etc.
- 2) Fabricating MS pipes specials etc from Mild Steel plates and other structural steel including all welding etc at contractor or approved nominated sub contractor's factory /Factories as per IS-3589 (Latest Revision) and M.C.G.M's requirement.

- 3) carrying out Hydraulic test to the specified pressure for the fabricated pipes in the factory.
- 4) Cleaning and painting of pipes, specials and any other fabricated materials with suitable paint externally or internally wherever required.
- 5) Loading in factory ,transporting to the site of pipe laying work wherever required by adopting suitable transporting means without any damages including all loading ,unloading and stacking carefully the pipes ,specials etc as required and as directed.

F-2 Procurement of material by the Contractor:

Materials required for fabrication of pipes, bends and specials etc Mild steel plates of required size and thickness shall be procured at contractor's cost conforming to IS 2062:2006 (or latest revision). The M.S. Pipes of dia. 1200 mm & above shall be manufactured from plates confirming to IS 2062- FE -410 Cu-WA (Copper bearing quality) with copper content as per product analysis between 0.17 to 0.38 percent & the M.S. Pipes of dia. below 1200 mm shall be manufactured from plates confirming to IS 2062- FE -410. The M.S. pipes shall be fabricated as per IS 3589(i.e. the fabricated company shall have ISI certificate for fabrication of respective dia. of MS pipes). Spirally welded pipes will not be allowed. Every 10th welding joint of mild steel pipe water main shall be tested in metallurgical laboratory for its strength.

The tenderer shall note that the payment towards procurement of M.S. plates for fabricating M.S. pipes / specials will be made as per tender item only. No extra charges / payment for using M.S. pipes fabricated from Fe 410 Cu-WA(copper bearing quality with copper content between 0.17% to 0.38 % as per specifications will be entertained / considered on any account.

All the pipe material should be procured from reputed manufacturers such as JINDAL SAIL, ESSAR, ISPAT etc .The contractor shall submit the original test certificate from the manufacturer for the grade of the material and yield strength.

One sample from each lot as per IS specifications shall be tested in approved laboratory at the cost of the contractor.

The contractor shall not start the fabricating of pipes and specials before the test certificate from the NABL accredited and approved laboratory conforming physical and chemical properties of steel to IS specification as above are submitted to the Engineer in charge.

The Contractor shall procure M.S plates and other structural steel required for fabricating pipes and specials considering the wastage's/scrap etc and rate quoted shall be inclusive of taking into consideration wastage's/scrap.

The contractor should carefully judge the balance fabricated quantities required before procurement of material once 90 % of the material quantities as per BOQ are procured and fabricated. The

balance quantity will be based on the final exact length of pipeline to be laid under the contract and the material will be procured by the contractor as per his best judgments M.C.G.M will not be responsible in any manner for under or over procurement nor for any delay or loss on this account.

F-3 Stacking of Plates and Other structural Steel in the Contractor's/Nominated fabrication factory and inspection and testing of the same:

The contractor shall intimate to the engineer in-charge well in advance the Programme of transporting and stacking MS plates and other structural steel etc at contractor's factory to enable the Engineer /Engineer's representative to make necessary arrangement for inspection and sampling for test.

F-4 Factory:

The contractor/Bidder's factory/nominated Fabrication Factory for fabrication work of M.S pipes and specials shall have an existing authorized and duly valid licensed factory for the fabrication of pipes and specials having the ISI license and ISO certificate. The Fabrication factory must be equipped with all necessary mechanical and electrical equipment in sound working order for carrying out the various operations involved in the work under the tender /Contract such as rolling, automatic welding, cutting, testing machining etc.

The fabrication factory must have previous experience of fabrication of M.S pipes by longitudinal and circumferential welding process only required for this tender. Spiral welding for M.S. pipes will not be allowed.

The fabrication factory shall have Hydraulic testing machines to test the M. S. Pipes for length ranging between 5 to 7 R.m. The Bidder prior to start of Fabrication shall furnish with his tender the details of factory where he intend to get the fabrication of pipe and specials done such as its location, the equipment, plant and other facilities available in the factory for manufacturing of MS pipes and specials required under this contract along with necessary credential documents of fabrication factory.

F-5 Fabrication of pipes:

Pipe shall be fabricated from the M.S plates and other structural component etc shall be fabricated from steel plates and other steel materials procured by contractor as mentioned in clause F-2. The welded joint shall be tested in accordance with the procedure laid down in IS: 3600 Part-I.

F-6 cutting of Plates /Rolling of Plates /Tacking of Drums /Assembly of drums into pipe:

The ends of finished pipe in the factory shall necessarily have bevel edge or V edge with or without shoulder cut /root face to facilitate hand welding in the field.

As field welding is to be carried out from inside in case of bigger diameter pipes i.e. 1200 mm and above ,the bevel edge for them shall usually from inside.

During fabrication of pipe cutting of plate, grinding of edges to develop smooth surface, to have straight cut edges should be adopted by the contractor.

The plate of required size cut as per above shall be put in rolling to form of pipe of required diameter. The contractor should adjust the rolling machine so as to give uniform curvature to the pipe throughout its circumference. In this regard necessary precaution and check should be kept by the contractor during rolling of plate into pipe.

Rolling drum should be kept on assembly platform for tacking, care being taken to ensure that the tacked drums have their end faces at right angle to the axis of the pipe .The tacked drums then transferred to an assembly platform where they shall be tack-welded together to form suitable pipe lengths. Plate shall be bent in the maximum possible width to reduce the number of circumferential joints.

The longitudinal joints shall be staggered at 90 degree .The drums when tacked together shall have no circumferential gap when the welding is done on automatic welding machine .But when hand welding is adopted as gap of 2 mm to 4mm shall be maintained to obtain a good butt welded joint. The assembly should be truly cylindrical and without any kinks. The faces shall be at right angle to the axis of the cylinder. A suitable arrangement for testing the correctness of the faces shall be provided by the contractor at the assembly platform.

F-7 Full Welding of the Pipes:

a) Electrode:

The contractor shall use electrodes of approved make and size depending on the thickness of plate and type of joint .Welding electrode shall confirm to IS NO .814 of 1967 “specification covered for

electrode for metal arc welding of mild steel pipe (second or latest revision)'.

For welding of pipes and specials in fabricating unit and also at site electrode confirming to IS: 814 and classified as EB542H3JX i.e. low hydrogen electrodes and equivalent to ADOR Welding Ltd 's brand name SUPERBASEXPLUS Electrode shall be used as per manufacturers specification . The corresponding SAW (Submerged arc welding) wire and flush shall be equivalent to ADOR welding Ltd. Brand's Auto Melt Gr EL -8, 4 mm dia wire and Auto Melt Gr.A55 Flux. After completing the welding of joints of pipe or plates from one side, the welding on the other side shall be taken up .Before starting the welding on the other side, the joints shall be gauged to remove irregular penetration on the even surface is exposed.

b) Testing of Welded Joint:

The welded joints shall be tested in accordance with the procedure laid down in IS 3600 of 1966."Codes of procedure for testing of fusion welded joints and weld metals in Steel."

The entire cost of the tests including taking out samples, machining the test pieces, transport to and fro the Laboratory and testing them in a laboratory ,the cost of patching up the tests piece hole in pipe, payment of all testing fees ,cleaning and painting etc shall be borne by the contractors. At least one test specimen shall be taken out from every 200 meters length of pipes fabricated.

F-8 Hydraulic Test:

Depending on the requirement of the pipe laying works, pipes will have to be manufacture in standard lengths of about 5.4 m to 7.2 m. The contractor shall provide machines and apparatus for testing all pipes of lengths standardized by the Engineer from time to time. Each fabricated pipe shall be tested at factory. The test pressure for pipes fabricated shall be 16 kg/sq cm.The pressure shall be applied gradually by approved means and shall be maintained for at least for 2 minutes as per IS 3589.The hydraulic test shall be carried out under the cover at fabrication shop in the presence and to the satisfaction of engineer.

Each pipe shall be legibly marked with the following details:

- a) Manufacturer's name or trade-mark;
- b) Inside diameter and specified Shell thickness;
- c) Pipe designation.
- d) Pipe Sr. No.

PIPE LAYING WORK SPECIFICATION:

F-9 Transporting:

All pipes and specials fabricated in Factory shall be transported to site of laying .The item of transport covers the cost of loading on the factory, transporting to the site of laying or to stacking yard. There shall be no free fall of fabricated material s while unloading .The material stacked at site shall be jointly inspected by the engineer and the contractor and any defect and damage noticed shall be repaired immediately to the satisfaction of Engineer.

F-10 Providing Steel Props from inside of Pipe:

In order to be able to provide effectively the cement mortar lining to the inside of the pipe line and to avoid the difficulties during the work, it is necessary that the pipes are maintained in circular Shape throughout the work. In order to achieve the same, steel adjustable screw type props of acrow or similar approved make should be fixed inside the pipe. The deflection of pipe should be limited to 2 % of the average dia. These props shall normally be fixed vertically at intervals not more than 1.8 m or as directed by the engineer. The props should be kept in position for at least for three days after encasing of the pipe in that section is completed or till refilling is done to the full height of fill over the pipe in case the pipes are not encased.

F-11 Precaution against Floatation:

Contractor should take necessary precaution to prevent the floatation of pipes laid in trench due to uplift.

Cutting Pipe faces to form Kinks and Bends in the Field:

If due to site requirement and other prevailing circumstances it is necessary to cut the pipe faces to form kinks and bends not greater than 5 deg or as and when directed by the engineer .Such cutting and welding shall be done and the same shall not be paid separately under any items of the Bill of Quantities.

F-12 welding in field:

Electrodes: The contractor shall use standard electrodes depending upon the thickness of plate and type of joint .They shall also use standard current and arc, voltage required for the machine in use as per manufacturer's directions. Welding electrodes shall confirm to BIS N0 814 of 1967," Specification for covered electrodes for metal arc welding of mild steel '(second or latest revision) Indian made or equivalent foreign make electrode of the required quality approved by the Engineer, shall be used wherever possible.

Gousing:

M.S pipes larger in size i.e. more than 900 mm dia will have to be welded internally and externally. At the time of internal welding, a 'V' cut is made from inside of the pipes and after completing the internal welding with required numbers of runs, the external welding (sealing run) is incumbent.

Before starting the external welding (sealing run) the internally welded material in the joint will have to be cleaned by Gousing with Gas flame. Gousing shall be done before starting the external welding (sealing run) and the rate of welding shall include the cost of Gousing also. Gousing will also be carried out before rectifying the defective welding wherever necessary and as directed by the Engineer.

Welding of pipe in the field shall comply with ISS No 816 of 1965 (Code of practice for use of metal arc welding for general construction in mild steel).

Testing of Field welded joints:

The field welded joints shall be tested in accordance with the procedure laid down in ISS no 3600 of 1966;” Code of procedure for testing of fusion welded joints and weld metals in steel” . A welding test piece is to be taken from field welded joints in one in ten proportions. The test pieces thus taken out shall be machined and tested in approved laboratory. All welding work at site are to be done through reputed welder only and supportive documents to that effect should be submitted to site incharge.

This hole shall be patched up by inserting and welding suitable sized plates.

Great care should be taken in preparing of these plates so as to get good Butt weld.

The entire cost of the tests including taking out samples, machining the test pieces, transport to and fro the Laboratory and testing them in a laboratory, the cost of patching up the tests piece hole in pipe, payment of all testing fees, cleaning and painting etc shall be borne by the contractors.

F-13 Insulated Flange Rings:

Insulated flange rings shall be provided for isolating the section of pipe line which may have to provide with cathodic protection in Future. Insulated flanges will have to be provided on cross – connections and also on tapping points. The contractor will have to provide the insulating Flange rings assembly consisting of the Bakelite ring and packing mounted between flanged pipe strikes.

Straps: Wherever pipe laying work is done from two faces and/or broken stretches due to any difficulty met with at site, the final connection has to be made by introducing strap cover gaps up to 300 mm length. Such straps shall be fabricated in the field by cutting pipes, sitting them longitudinally and slipping them over the ends to be connected in the form of collar. The collar shall be in two halves and shall have its inside diameter equal to the outside diameter of the pipe to be connected. Such strap shall be welded by fillet weld internally as well as externally for pipe dia above 900 mm.

F-14 Pipe Line testing:

After the work of laying of pipe line is completed and before putting it to commission, the pipeline shall be tested in the field as and when directed by Engineer, both for its strength and leakage. The test pressure shall be not less than the static head pressure or 1.5 times the working pressure whichever is higher. The test pressure shall be maintained for 24 hours. The drop in pressure shall not exceed 0.7 Kg/sqm (10 lbs /sq. inch) within period of 2 hours after the full test pressure is built up. The section of pipe line shall be subjected to a hydraulic test in full length or in part as may be found necessary. The water required for flushing and testing the new water mains will be made available free cost of by M.C.G.M through the cross connections of newly laid water main and existing water main subject to availability of water. However water required for pressurizing the water main during testing should be arranged by the contractor.

10.5 ADDITIONAL SPECIFICATIONS

A Storm Water Drain Works:

1. The work under this contract requires execution in Nallas/S.W.D subjected to tidal fluctuations moreover, even during fair-season the Nallas/S.W.D carry appreciable quantity of sillage. This fact should be borne in mind by the tenderers while quoting their percentage
2. During the course of the work it will be essential to construct temporary coffer dams as and when found necessary and extensive pumping will have to be resorted to for making the site for working conditions. It may be noted that no separate payment for this purpose will be made either for constructing cofferdams or pumping.
3. The coffer dams should be constructed as found necessary for proper progress of the work and approved by the Engineer.
4. In order to neutralize the action of possibility of uplift forces 150 mm diameter, M. S. pipes 250 mm long and 10 mm thick shall be inserted vertically in the concrete bed of the nalla before concreting. These pipes will be in two rows at a distance of quarter width from the nalla edge and 3 m centre to centre and in a staggered manner. It may be noted that no separate payment will be made for this purpose. However, while paying for the concreting in the nalla bed the whole area of the nalla bed shall be taken into consideration i.e., no deduction in the concrete quantity due to the pipes.

5. Adequate working areas may not be available for construction activities. Hence, the contractors may be required to construct accesses wherever feasible, at their own cost. Arrangements for movement of the trucks, machinery etc., along the entire length of the work will also have to be done by the contractors at their own cost. Wherever it would not be possible for the transport to reach the site of work, the contractors will have to resort to carrying the material by head-load for which no extra payment will be made. During excavation for the work, it may be possible for the contractors to stack excavated material required for back filling after completion of the retaining wall, due to inadequate working place. In such an eventuality, the contractors would be required to transport the excavated material away from the site and bring back the same for refilling at their own cost.
6. The contractor should note that in case where it will not be possible to provide necessary water way for the diversion of water course of nalla due to its inadequate width it will be necessary to block the complete water way and make such arrangements either to divert the flow or to resort to pumping the water from upstream side to downstream of work site by using any number of pumps for any length of time. Waterway of the diverted way shall be more than original. Permission to block the complete water way shall be given only after inspecting this arrangement. If work cannot be completed before rains, original water way be restored. No extra payment on this account shall be entertained.
7. The payment for excavation shall be made on cross sectional basis. Before starting the work, initial levels will be taken at every 7 m or less depending on site conditions along the entire length of the proposed work. Levels at every 5.00 m intervals would be taken along the width of the section. The quantity of excavation would be computed on the basis of levels thus taken by resorting to the Prismoidal Formula. For establishing the datum line, the average of the two end points of the ultimate cross-section required for excavation work will be considered.
8. Normal foundation depth in the section is based on the assumption that good strata (i.e. having bearing pressure of 15 t/Sq. m) will be available at a depth of 1.5 m below the final invert level and up to the top of rubble-soling. In case the soil is not of good quality, it will be necessary to have a deeper excavation, as directed by the Engineer, and the section of the masonry walls will be proportionately modified and payment will be made accordingly.
9. Repairs to the damaged S.W.open drain, drain pipes, water entrances shall be carried out by the contractor, as directed by the Engineer, for which payment will be made to the contractor.

B Water Main Works:

1. The work of water mains shall be considered complete only after successful pressure test, contractor shall arrange for testing as specified, otherwise, the same shall be tested by the M.C.G.M. at the risk and cost of the contractor.
2. If a part of a completed line is required for commissioning, the same shall be handed over to the Corporation after specified testing.
3. No extra payment for carrying the material by head load to work site shall be considered under any circumstances.
4. The cross connection works etc. are required to be planned in view of the water supply hours in a particular area. Extra payment shall not be considered for works carried out during early, late or night hours. If contractor fail to carry out the work within the non-supply hours, the same shall be carried out by M.C.G.M. at the risk and cost of the contractor and recoveries shall be affected from the dues payable to the contractor.
5. The contractor, at their cost, shall submit two sets of "As laid" drawings of water main showing actual alignment, levels, dipping etc. as per the offsets and levels taken during the execution of the work.
6. The contractor (s) shall note that only 95% payment of payable amount towards the water mains will be released for the completed work and balance 5% shall be released after completing the following works:
 - a) *Testing of pipeline satisfactorily & obtaining necessary test certificate.*
 - b) *Reinstatement of trenches.*
 - c) *Returning of reclaimed materials to the Municipal store if any.*
7. The contractor shall provide at his cost 20mm.thick minimum 3 m x 2 m or 4 m x 2 m M.S plates for covering the trenches temporarily at road crossing or building entrance, as directed by the Engineer.
8. The lead joints are not allowed for laying of water main/s. If needed the specific sanction of Concerned Executive Engineer shall be obtained for the same.

10.6 FOR CEMENT CONCRETE ROAD WORKS:

1. In addition to the qualities of strength and durability, greater attention will need to be devoted to the qualities of the pavement surface, which directly affect the user perceptions, comfort and safety. In this connection, the wear resistance, surface evenness (riding quality) and skid resistance, as well

as freedom of the surface from structural or other quality blemishes (e.g. cracks, joint and edge spells, surface pitting / pop outs, scaling / potholes, etc.) will need additional attention.

2.The contractor shall have the full responsibility for quality control and also in delivering the requisite quality in the field.

3. The cement and other materials shall be tested at the approved Lab., at contractor's cost, preferably before its use, as per the directions of the site in charge. In case, the test results are not available before its use, the use of the materials shall be permitted on the explicit understanding that they will remove and redo the work at their own cost in case the specimens fails to attain the specified tests.

4.Ordinary Portland Cement of 43 and above grade, Portland Pozzolana Cement or Portland Slag Cement will be allowed to be used for RMC/conventional mix. Contractor shall provide one independent cement godown with capacity of minimum 50 to 200 cement bags, under double lock system with one lock of contractor & other of M.C.G.M as per the site conditions & as directed by Engineer in Charge.

5.The rates proposed in this tender for all concrete and allied works are inclusive of water cost. The contractors shall have to make their own arrangements at their cost for bringing adequate water of potable quality for mixing concrete, curing purposes etc. and for this no extra payment will be made.

6.Water used for mixing and curing of concrete shall be clean and free from injurious amount of oil, salt, acid, vegetable matter and other substances harmful to the concrete. It shall meet the requirement stipulated in IS 456. The water brought for concreting and curing etc. shall be got tested from Municipal laboratory (situated at G/North ward office) to verify whether it is suitable for above purposes, whenever directed. This testing will be done at contractor's cost.

7.Sand shall be of approved quality with fineness modulus between 2.4 to 3.5 as per approved mix design. The sand will have to be screened to remove the oversized particles and washed to reduce the silt contents below 8% by volume after one hour and to bring it within the permissible range of fineness modulus. The fine aggregates will be tested as directed by the Engineer.

8.If coarse aggregates are found having white spots, the same shall be got tested from approved testing laboratory to eliminate possibility of potential aggregate- alkali reactivity before accepting or using spotted aggregates.

9. The contractor should make the necessary arrangement to stock the aggregates separately so that they do not get mixed up with each other and / or with the foreign materials and do not get segregated. The screening of the aggregates shall be done if found necessary as directed by the Engineer.

10.M.S / Tor steel and structural steel required for the work shall conform to the relevant latest Indian Standard Specifications. The steel brought on site shall be got tested at Municipal or any other approved laboratory at the contractors cost before using on site.

11.To determine the 'K' value, it is necessary to take a plate load test / CBR test within the scope of the work wherever necessary. The test will be taken by A. E. (soil Mech.). However contractor shall arrange at his cost for excavation, loading and refilling. No payment will be made for this work. For conversion of K - value to CBR value, the value of CBR / K value shall be adopted from **IRC: 58-2002**, as detailed below:

APPROXIMATE 'K' VALUE CORRESPONDING TO CBR VALUE FOR HOMOGENOUS SOIL SUBGRADES

CBR value (%)	2	3	4	5	7	10	20	50	100
K-Value (Kg/cm ³)	2.08	2.77	3.46	4.16	4.84	5.54	6.92	13.85	22

The recommendations of IRC: 15 – 2002 shall be followed and K-value of less than 5.5 kg/ cm³ tested on the sub grade shall not be permitted. In case, a large number of tests are required either in view of low K-value obtained, or in view of heterogeneity/ variability of sub grade, additional field soaked CBR test may be conducted using the above table for assessing the K-value. The final checking will, however, be based on plate bearing test. In case the 'K' value is less than 5.5 kg/cm³ (C.B.R. less than 10.0); the C.B.R. shall be improved with intermediate GSB sub base as decided by the Executive Engineer.

12. Testing for the compressive strength shall be carried out for cement concrete works of M 35 & above for each day's work. At least three sets consisting of 3 nos. of cubes (at regular interval) along with 3 flexural beams shall be cast. Cubes from each set shall be tested for 7 days & 14 days at the site laboratory in presence of Asstt. Engr. i/c of the work & the contractor shall submit remaining three C.C cubes for testing compressive strength for 28 days at the approved Laboratory. Also, the contractor shall cast & submit for each day's work, 3 flexural beams for testing flexural strength at the approved Laboratory as per the requirement of project & as directed by Engineer in Charge.

13. Whenever the cubes and beams are required to be sent to the laboratory, the same shall be transported to the Laboratory by the contractors at their cost. The acceptance criteria for the test result shall be as per IS. 456. No payment for this will be made to contractors.

The contractors shall arrange to send the cubes and flexural beams to the testing laboratory at least one days before the date of testing of the cubes as well as beams failing which penalty of Rupees 1000/- per day will be imposed and recovered from the contractors bill. The charges for testing of cubes and beams at municipal laboratory shall be as per rate schedule fixed for testing by the office of A.E (Soil Mech.) M.C.G.M. Lab at Worli from time to time and the same shall be borne by the Contractors.

Quality control in the field shall be exercised on the basis of compressive strength and workability. The maximum water cement ratio shall be 0.40.

14. In case of concrete of less than M 35, at least two sets of cubes shall be cast and tested for 7 days and 28 days strength in site lab. on the compressive testing machine for day's work.

15. At each Road, minimum 3 cores for day's work of M 35 & above C.C shall be extracted at regular interval for any four day's work for testing. The average value of test results of 3 cores shall be considered for deciding the concrete strength for the day's work from which the cores are extracted. The cores shall be extracted preferably from the slabs of the standard size i.e. 45 M x 3.25M (on either longitudinal side of the work). (The testing of core is to be done if quantity is substantial like length of trench is beyond 500 mtrs and 3 mtr width etc)

The extraction of core shall be arranged in such a way that three cores are extracted in a day's work of M 35 & above C.C. at regular interval. The average test result of three cores shall decide the core strength of the day's work. If average strength fails, the entire quantity of M 35 & above concrete poured on that day will not be paid.

In case the cube test for 28 days period fails, for any particular day's work, additional 3 cores shall be taken from that day's work and will be tested at contractor's cost. The core will be 150 mm. dia. If it fails, no payment will be made.

16. The density of the compacted concrete shall be such that the total air voids are not more than 3%. The air voids shall be derived from the difference between the density of core and that of concrete cubes taken for the said day's work. The average value of three cores of at least 100 mm diameter shall be considered.

17. All cores taken for density measurements shall also be checked for thickness. In case of doubt, additional cores may be ordered by the Engineer and taken at locations decided by him to check the depth or density of concrete slab without any compensation being paid for the same. Thickness of the slab at any point checked as mentioned above shall have minimum specified thickness as per drawing.

The cost of the Cores & samples to be taken and their testing shall be borne by the contractors. Cores of slab of M: 35 & above C. C. shall be extracted and submitted within a week's period after completion of 28 days in the laboratories approved by the Ch.E (Rds. & Tr.). On failure of compliance of this conditions a penalty of **Rs 1000 /- per day** shall be imposed. However, in the circumstances beyond contractor's control, the matter of waiving penalty will be reviewed by the Hydraulic Engineer (H.E).

18. In calculation of the density, allowance shall be made for any steel in cores. Cores shall be reinstated with epoxy mortar or as directed by the Engineer at the contractor's cost. In case the cores are taken from the road already opened to traffic, the mix / material adopted for filling shall be such that it will develop the requisite strength in a minimum period. The holes created by cores shall be so filled that these do not shrink. The core holes shall be reinstated within 24 hours of taking cores, failing which a penalty of **Rs 1000 /- per day** shall be charged.

19. Core density test shall be carried out in accordance with relevant I.S. Codes.

The results of crushing strength tests on these cores shall not be less than 0.8 times the characteristic cube crushing strength where the height to diameter ratio of the core is two. Where height to diameter ratio is varied then the necessary corrections would be made in calculating the crushing strength of cores in the following manner.

The crushing strengths of cylinders with height to diameter ratio between 1 and 2 may be corrected to correspond to the standard cylinder of height to diameter ratio of 2 by multiplying with the correction factor obtained from the following equation:

$f = 0.11n + 0.78$ where f = correction factor and n = heights to diameter ratio

The corrected test results shall be analyzed for conformity with the specification requirements for cube samples. Where the core tests are satisfactory they shall have precedence for assessing concrete quality over the results of moulded specimens. The diameter of cores shall not be less than 150 mm.

20. If the test results of cores of the concrete are not satisfying the strength requirements, then the payment for the slab/day's work shall not be made.

21. If the contractors excavate certain portion of the road and fails to reinstate/concrete the same within the stipulated time limit as per the programme on / or before 15th May of the year or any other date specified by M.C.G.M authority as per the policy, they will be required to reinstate this excavated road portion with bituminous layers / paver blocks as specified and directed by the Engineer failing which the same will be carried out from any other agency at the Contractor's risk & cost, in addition to further penal action. No payment will be made for such restoration.

22. The contractors should also note that they will have to modify, if required, the detailed programme submitted in the form of BAR chart or PERT/CPM, considering the permission obtained from Traffic Police before actual starting of the work at site so as to complete the same in the stipulated contract period.

23. Mix design to give the target strength as required shall be prepared in accordance with the relevant IRC / IS specifications. The same shall be checked and approved by the Asst. Engineer / Executive Engineer.

24. Minimum Cement content for M 40 Grade of Concrete shall be 350 kg/cum. If this minimum cement content is not sufficient to produce the strength of concrete specified in the drawing/design, it shall be increased as necessary without additional compensation under the contract, or else the fresh mix design shall be carried out till desired results are achieved.

25. The water bound macadam/ W.M.M. base should be adequately watered on the previous day and also two hours before starting lean concreting work so as to keep it in moist condition.

26. Double bulkheads for keeping the dowel bars in the proper alignment shall be provided as per drawing, and as directed by the Engineer. Tie bars should be aligned exactly perpendicular to finished concrete surface of the slab by means of suitable device to be approved by the Engineer.

27. Dowel bars shall be Mild steel rounds in accordance with details / dimensions as indicated in the drawings and free from oil, dirt, loose rust or scale. They shall be straight, free from irregularities and the sliding ends sawn or cropped cleanly with no protrusions outside the normal diameters of the bar. The dowel bars shall be supported on double bulk - head or chairs in prefabricated joint assembly position as approved by the Engineer prior to the construction of the slabs.

Unless shown otherwise on the drawing, dowel bars shall be positioned at the mid depth of the slab within the tolerance of ± 20 mm spaced equally along intended lines of the joints within tolerance of ± 25 mm. They shall be aligned parallel to the finished surface of the slab, to the centerline of the carriage way and to each other within the following tolerance.

For the bars supported on bulk - head prior to the laying of the slab.

All the bars in a joint shall be within ± 4.5 mm per 300 mm length of the bar. $\frac{2}{3}$ rd of the bars shall be within ± 3 mm per 300 mm length of the bar. No bar shall differ in alignment from adjoining bar by more than 3 mm per 300 mm length of the bar in either horizontal or vertical plane.

The Dowel bars shall be covered by a sheath of High Density Polythene pipes of approved quality for half the length plus 25 mm for expansion joints. The sheath shall be tough, durable and of an average thickness, not less than 1.25 mm. The end portion of the sheath shall be plugged with suitable properly tight cap fitting.

28. All the trenches & loose pockets, excavated pit etc. will be refilled by metal sand filling or as specified and directed by the Engineer.

29. The laying of M10 concrete in pavement will have to be carried out with proper form work only. It shall be ready mix concrete compacted with vibrators and shall have smooth surface. It should have proper cross profile as directed by the Engineer. The surface of M10 C.C. shall be maintained smooth till overlaid by slab of M35 & above C.C. The work will have to be carried out as directed by the Engineer.

Curing shall be done by covering with Hessian cloth and sprinkling with water for 7 days or till the lean concrete is overlaid by M35 & above C.C. slab, whichever is earlier, but for a minimum period of 24 hours.

30. 3 Ply Waterproof paper or 125 micron plastic membrane shall be used as a separation membrane between concrete pavement slab and the sub base at the same terms and conditions. No extra payment shall be made for plastic membrane.

31. For the desired workability, the ready mix concrete of M 35 & above will have a slump not more than 50 +/- 10 mm.

32. The temperature of Pavement Quality concrete shall be maintained as per **IRC: 15: 2002**. Concrete having temperature at the time of pouring more than 30°C will not be allowed.

33. M35 & above concrete slab shall be laid in two layers and each layer shall be compacted by needle vibrator, plate vibrator. Screed vibrator shall be used for compaction of 2nd layer in addition to the with needle and plate vibrator.

34. To achieve the proper consolidation of the concrete slab, the top layer of the concrete shall be compacted by needle vibrator, plate vibrator and Screed vibrator. If any depressions are observed on the surface of the concrete, fresh concrete shall be spread on the top, surcharged and got compacted with batten. Screed vibrator is again to be used for compaction as well as leveling. Minimum 3 skilled masons shall be deployed during M 35 & above concreting work.

35. Care shall be taken to prevent the over vibration and appearance of water / laitance on top surface of the slab. If any excess water is noticed on the surface of the slab, the same shall be removed by moving hessian cloth on top surface and the concrete mix shall be immediately rectified as directed.

36. Plate vibrators shall be used for compaction of concrete mix in addition to needle and screed vibrator and as such contractors must have at least two numbers of each machine such as plate vibrator, screed vibrator and at least three needle vibrators in working condition.

37. The distance as well as time lag between bottom concrete layers and top layers during concreting operation shall not exceed 2.5 meters, or 20 minutes whichever is less.

38. Whenever the needle vibrator is used, the mason must follow with a trowel and punch to the portions of concrete from where the needle vibrator is withdrawn to ensure that no hollow portion remains in the stiff mass of concrete. Plate vibrating shall also follow thereafter immediately.

39. Concrete pavement must be in proper cross profile as per camber prescribed by the Engineer.

40. After the final regulation of the surface of the slab, surface of concrete slab shall be brush textured in a direction at right angles to the longitudinal axis of the carriageway.

41. The brushed surface texture shall be applied evenly across the slab in one direction by the use of a wire brush not less than 450 mm wide. The brush shall be made of 32 gauge tape wires grouped together in tufts spaced at 10 mm centres. The tufts shall contain an average of 14 wires and initially be 75 mm long. The brush shall have three rows of tufts. The rows shall be 20 mm apart and the tufts in one row shall be opposite the centre of the gap between tufts in the other row. The brush shall be replaced when the shortest tuft wears down to 60 mm. long.

<i>Time test</i>	<i>Number of measurements</i>	<i>Required texture depth</i>	
		<i>Specified value</i>	<i>Tolerance</i>
Not later than 6 weeks or before the road is opened to public traffic	An average of 5 measurements	1.00	+0.25 -0.35

42. The texture depth shall be determined by the sand patch test as described in the clause given below. The test shall be taken at least once in a week or whenever the Engineer considers it

necessary, at times after constructions. 10 individual measurements of the texture depth shall be taken at least 2 m apart anywhere along the diagonal line across a lane width between points 50 m apart. No measurements shall be taken within 30 mm of the longitudinal edges of the concrete slabs. The texture depth shall not be less than minimum required as per the table below, nor greater than a maximum average of 1.25 mm.

43. After the application of the brushed texture, the surface of the slab shall have a uniform appearance.

44. Where the texture depth requirements are found to be deficient, the Contractor shall make good the texture across the full lane width over length as directed by the Engineer, by retexturing the hardened concrete surface in an approved manner.

44.1 The following apparatus shall be used for testing the texture depth.

- i) A cylindrical container of 25ml. internal capacity.
- ii) A flat wooden disc 64 mm diameter with a hard rubber disc, 1.5 mm thick, struck to one face, the reverse face being provided with a handle.
- iii) Dry natural sand with a rounded particle shape passing a 300 micron IS sieve and retained on a 150 micron IS sieve.

44.2 Method: The surface to be measured, shall be dried, any extraneous mortar and loose material removed and the surface swept clear using a wire brush both at right angles and parallel to the carriageway. The cylindrical container shall be filled with the sand, tapping the base 3 times on the surface to ensure compaction, and striking off the sand level with the top of the cylinder. The sand shall be poured into a heap on the surface to be treated. The sand shall be spread over the surface, working the disc with its face kept flat in a circular motion so that sand is spread into a circular patch with the surface depressions filled with sand to the level of the peaks.

44.3 The diameter of the patch shall be measured to the nearest 5 mm. The texture depth of concrete surface shall be calculated from $31000/(D \times D)$ mm where D is the diameter of the patch in mm.

45. It will be the responsibility of the contractor to give the required finish of riding surface by checking with the straight edge and wedge gauge and any deficiency observed, shall be rectified as specified in the general specifications for Road Works.

46. Initial curing shall be done immediately after the surface texturing. Initial curing shall be done covering with hessian cloth and sprinkling with water over the concreted portion as soon as the concrete starts setting and by the application of approved resin based aluminized reflective curing compound which hardens into an impervious film of membrane with the help of mechanical sprayer. Care should be taken not to disturb the brushed surface texture. Further curing of concrete shall be done as directed, for a minimum period of 14 days from the date of casting of c.c. slab or as directed. A penalty of Rs1000/- per Sq.m per day will be levied for broken vatas. A penalty of Rs10000/- per day will be levied for improper curing.

47. The vertical sides of concrete slab are required to be tarred with hot/cut-back bitumen of 80/100 grade before casting of the adjoining relevant bay. The channels should be erected perfectly in vertical position. The gaps between two channels shall be properly covered by waterproof papers and the gaps at the bottom shall be properly sealed in C.M. for which no extra payment will be made.

48. The contractors shall have to cast runner beams, man hole bay, water tables, water entrance bays etc. preferably within 5 days from the date of casting slab failing which a penalty of **Rs 1000/- per**

day shall be levied on contractors.

49. The cement concrete slab pavement in M35 & above is required to be carried out strictly as per the drawing. As regards thickness no claims on account of additional thickness other than the specified, if provided, will be entertained.

50. The flexible pavement wherever necessary shall be improved in asphalt mix, paver blocks or by other methods as directed by the Engineer, before allowing the traffic on adjoining completed C.C.slabs. In case it is not possible, a specific sanction of Dy.H.E(Const) should be obtained before allowing traffic on C.C slabs.

51. The joints shall be cut within 10 hrs-16 hrs. to a depth of 100mm or min.1/3th depth of C.C.bay, as directed, failing which these will be got done at contractor's cost and penalty will be levied as directed by Engineer including withholding the payment of adjoining panels of the uncut joints for 5 years. A suitable rebate for less depth i.e in between 75 mm to 115 mm will be taken on prorata basis. A proper record shall be maintained in the register.

52.The machine cut joints should be filled in immediately with thermocole as directed by the Engineer till regular dressing of joints is done. Separate payment will be made for this work.

53.The machine cut joints and expansion joints must be cleaned first by using Raking tool and then air blown with compressor, so as to remove dust, sand particles and foreign matter from the joints before filling them with hot sealing compound as specified in **IS 1834-1984**, after applying primer conforming to **IS 3384-1986**.

The details of sealing compound and bituminous primer to be followed as per M.C.GM Road Department specifications.

54. No separate payment for restoring vattas before and after cutting of joints or damaged on any account shall be made. Such vattas shall be restored immediately by the contractors. After curing period is over, the vattas shall be removed thoroughly, without keeping behind any vatta impression and without damaging the surface texture of the slab.

55.The contractors shall observe compliance of following requirement in respect of works of sealing of joint.

55.1 The contractors shall have to purchase the joint sealing compound from open market and from reputed manufacturers, a list of which is available in the office of respective Dy.Ch.Engr.(Rds). The sealing compound shall conform to Grade 'A' of IS 1834-1984 i.e 'Specifications for hot applied sealing compounds in Concrete'. The Sealing compound shall have to be got tested at Municipal Laboratory or at the V.J.T.I, I.I.T or S.P college Laboratory or at the laboratories approved by Ch.Engr.(Rds. & Tr.) at contractor's cost before its use for every batch in addition to manufacturers' test results of sample.

55.2The Delivery challans for joint sealing compound shall bear requisite details, such as Sr.No., Batch No., Date, Weight and name of the contractor to whom the sealing compound is being supplied etc. The manufacturer's Test Certificate to the effect that sealing compound conforms to relevant I.S. specifications shall invariably accompany every consignment of sealing compound, brought on the site.

55.3Due care shall be taken to see that temperature is carefully controlled while heating the joint sealing compound. Due precautions shall be taken to avoid over-heating of joint sealing compound above 180 degree Celsius as well as heating for long periods since sealing compound will lose its properties due to overheating. In case of default on this account, entire overheated material will be

rejected. Therefore, quantity of sealing compound required for one operation of joint sealing work shall be heated.

55.4 Joint sealing compound once heated but not utilized will not be permitted for use after reheating the same and such material will be discarded and will have to be removed from site.

Indian Standards (IS & IRC) for work of sealing of joints and quality control:

i) IRC 15-2002 Standard Specifications & Code of Practice for constn. of Concrete Roads.

ii) IRC 57-1974 Recommended practice for sealing of joints in Concrete Pavements.

iii) IS 1834-1984 Specifications for hot applied Sealing Compounds in Concrete.

iv) IS 3384-1986 Specifications of primer.

55.5 The joints cut and cleaned shall be got certified from the Engineer before filling with sealing compound as per the specification for sealing of joints in rigid pavements. The spilled over sealing compound if any shall be removed immediately.

56. The regularity of the surface of the slab shall comply with the requirement of following clause.

56.1 Compliance with the requirements of this clause for surface regularity shall be measured using an approved 3 m long straight edge and wedge in such a way as to reveal any and all irregularities. The maximum permitted number of surface irregularity of 5 mm and 7 mm in a length of 300 m shall be 20 numbers and such irregularities shall be properly recorded in the register.

56.2 Longitudinal irregularity shall normally be measured along any line or lines parallel to the edge of the slab.

56.3 Transverse irregularity shall normally be measured along any line with the straight edge placed at right angles to the centre line of the road.

57. If deemed necessary by the Engineer, any section of the slab which deviates from the specified levels and tolerance shall be demolished and reconstructed at the Contractor's expense.

58. *There shall be a defect liability for 5 years period (60 months) for C.C. pavement.* If during this period, concrete road fails due to (1) development of cracks (2) Spalling of edges (3) Erosion of concrete surface etc., the action as decided by the engineer shall be taken against the contractor. In case of development of structural/full depth cracks, 25% cost of the slab per cracked panel shall be recovered as penalty. The penalty amount shall not exceed cost of respective slab. However, for cracks in M.H.bays, entire cost of M.H. bays shall be recovered. If the contractors replace the cracked panels within the guarantee period, the said amount shall be paid separately. It is obligatory on the part of contractors to take care of such cracks during the guarantee period. During the defect liability period, dressing of joints complete in all respect shall have to be done free of cost at least once in a year preferably in the month of April or May or as directed by the engineer under municipal supervision. If the contractor fails to comply with the above conditions, the note of the same will be taken while evaluating the tenders for C.C. road works in future.

In case of disputed cracks, nature of cracks may be ascertained by extracting core on the crack in question by the contractor at his cost. If the depth of the penetration of the crack observed on the core is more than 1/3rd the depth of the slab, the crack will be considered as structural crack. Reinstatement of the core holes shall be as per in the relevant tender condition.

59. The contractor when called upon will take up the additional work and complete the same at their rates, terms & conditions of the contract without claiming any compensation and work shall be completed within the time period allotted to this contract. All taxes/duties etc. will be borne by the contractors and not by the M.C.G.M.

60.If any contractor fails to carry out work, the same will be got executed at his risk and cost, through other agencies.

61. The works shall be carried out at least at 3 to 4 locations simultaneously if necessary; so as to complete the work in stipulated time.

62.Ready mix concrete will be brought to the site from RMC plant only by transit mixers.

a) Every transit mixer will carry delivery challan, mentioning the minimum following details:

- i) Name of Manufacturer and Depot.
- ii) Serial No. of challan.
- iii)Date
- iv)Truck No.
- v) Name of contractor to whom the RMC is being supplied.
- vi)Location of contract work.
- vii) Grade of concrete.
- viii) Specified workability.
- ix) Cement content and Grade of cement.
- x) Time of loading
- xi) Quantity of concrete.

b) A computerized print out showing details of ingredients or ready mix concrete including admixture viz. the actual weight of each ingredient, required weight of each ingredients as per mix design etc. shall invariably be obtained with each transit mixer carrying RMC on site. The computerized sheet shall be signed by the site in charge and contractor's representative and shall be preserved as a record on the site.

63.The Pavement Quality Concrete should be produced in RMC plant using ice flakes to control the temperature of concrete and no extra payment will be made for the use of ice flakes in concrete. The Pavement Temperature of Pavement Quality Concrete should not exceed 30°C at the time of pouring.

64. When the truck arrives on site, the drum should always be speeded to about 10 to 15 rev/min, for at least 3 minutes, to make sure that the concrete is thoroughly mixed and uniform, before discharge.

65.Testing of Ready Mixed Concrete: The sampling and testing requirements for ready mixed concrete are the same as those for site mixed concrete. As regards testing of workability, following procedure be followed.

After making sure that the concrete has been uniformly mixed, take a sample from the first 0.5 cu.m of concrete discharge, and do a slump (or compacting factor) test on the sample. If the result complies with the specified requirements, then the load should be accepted. If the results are beyond limits, a further sample should be taken from the second 0.5 cu.m of the discharge, and if this is satisfactory, the load should be accepted, if not, the concrete load shall be rejected, as the same is not as per the specification range. The specified slump is 50 mm while carrying out above tests, it may vary by 10 mm.

66.No extra payment will be made for the use of admixtures.

67.It will be the sole right of the Administration to allow or disallow the use of ready mixed concrete in specific works based on the site situation, number of works, distance of plant from the site of work, etc.

68. LIST OF MACHINERY REQUIRED TO BE PROVIDED BY THE CONTRACTOR'S FOR CEMENT CONCRETE ROADWORKS AT EACH STRETCH OF CIVIL WORK.

1. Screed vibrator - Min.two Nos
2. a) Min. two needle vibrators (60 mm) &
b) Min. two needle vibrators (40 mm)
3. Min. two plate vibrators for compaction of concrete & two vibratory plate compactors for compaction of trenches, paver blocks etc.
4. At least two water tanks of 5000 Ltrs. capacity each.
5. 3 steel battens of channel section of 4" width with proper handles at both the ends.
6. 2 straight edges with scaled wedge.
7. Requisite finishing instrument.
8. One joint cutting machine for cutting minimum 100mm depth with two spare blades.
9. M.S channels minimum 200 R.M in length in proper shape, line and level.
10. 4 set of double bulk-heads as per drawing.
11. steel fabricated farmas for raising manholes.
12. Portable air compressor.
13. 2 templates for checking camber.
14. 20 cube moulds, 150 mm x 150 mm x 150 mm
15. 1 slump cone with two additional measuring rods.
16. Steel fabricated moulds for casting kerbs, water tables etc.
17. Two joints raking tools.
18. 6 flexural beam moulds of size 700 mm x 150 mm x 150 mm.
19. 15 mm internal dia M.S. pipes for straightening the tie bars.
20. Two nos. steel wire brooms as specified.
21. Min.two sprinklers.
22. Levelling instruments.
23. Two pharmas
24. a) Measuring tape b) Steel tape
25. Generator Set - 01No
26. Digital Thermometer - 02 Nos
27. Wooden Platform - 02 Nos

Contractor must procure all the aforesaid equipments and machinery before commencement of the respective work in good working condition.

- 69.** All the specifications laid down by IRC and as detailed in the relevant clauses of MORTH-(2001) Manual on Specifications for Road and Bridge Works in respect of Construction of Drainage Layer, Wet Mix Macadam, Dry Lean Concrete should be strictly followed.

10.7 FOR ASPHALT ROAD WORKS :

- 1) Loads of asphalt mix brought on lorries shall be fully covered with tarpaulin, failing which ***Rs2500/- for every lorry load*** received on the site uncovered with tarpaulin will be imposed as penalty and the same will be recovered from the contractor's bill.
- 2) The lorry loads of the asphalt mix shall be checked at random at public weigh Bridge including the Tar Weight for verifying the correct weight of the mix at the rate of one load out of every ten loads.
- 3) Various asphalt mix challans shall bear printed serial no. Weight and departure time from the plant end. The test reports of the test conducted in the asphalt plant laboratory shall invariably accompany with the first load.

- 4) While laying asphalt mix layers on the existing road surface, care shall be taken to see that no manhole or chamber covers of drainage, etc. are buried or kept higher than road surface. They shall be first identified and raised or lowered to be flushed with final asphalt surface.
- 5) Prime coat/Tack coat will be allowed during execution of resurfacing work only by mechanical sprayer.
- 6) Field Density test shall be taken in Asphalt Concrete Carpet, W.M.M.,D.L.C. and GSB.
- 7) The contractors shall bring the correct size of metal/material required for construction of water bound layers. The contractors will not be allowed to break stones, preparation of material for water bound layers on site.
- 8) As far as possible, 30% of the milling material shall be used on site, wherever directed.

10.8 TESTING OF MATERIALS:

Contractors are required to send at least one sample per day up to 50 M.T. and at the rate of one sample for every additional 50 M.T or part thereof per day for Asphalt Macadam/ Seal Coat/Asphalt Concrete and other asphalt mixes to the laboratory for testing. The contractor shall note that, 50% payment of the bitumen work will be withheld till the results are received.

The test of samples of asphalt macadam, asphaltic concrete, mastic asphalt, used in the work shall be carried out at municipal laboratory or approved laboratory as directed by engineer in-charge.

The site laboratory shall be used for testing of sub-base, GSB, base course, WBM, concrete cubes (7 days, 14 days) and other materials as necessary and directed engineer in-charge.

The charges for testing of construction materials and asphalt mixes shall be as per the rates in force at the time of testing of materials/asphalt mixes and the testing charges shall be borne by the contractor.

i) All requests for testing of samples must be made in writing to in duplicate specifying there in the following information (separate memo should be sent for concrete, steel, soil, asphaltic mixes) etc.

1. Name of the Work, Work Code No. if any
2. Type of material and tests desired (i.e. grade of cement, date of consignment)
3. Identification mark on the sample should be mentioned on the forwarding memo (in case of concrete beams and cubes identification marks, grade of concrete, date of casting, specimen No. should be engraved on concrete. If these details are marked by paint, samples will not be accepted. In case of re-inforcement bars, details shall be displayed on label pasted on bars and label must be signed by the officer who has taken the samples.)
4. Name and full postal address of the officer to whom the results must be sent.
5. Date of sampling (i.e. date of laying asphalt mix, Sr. No. of load casting concrete or taking cement samples.)
6. Name of the tenderer carrying out the work.
7. Any other information, which is specified by the user department.

- ii) Samples must also bear the identification mark and signature of site in charge/ officer taking the samples. In case of samples of asphalt mixes sent in polythene bags a legible duplicate tag should be stapled from outside.
- iii) Quantity of sample for testing must be adequate as shown in the schedule.
- iv) For issuing additional copies or duplicate copies of test results at Municipal Testing Lab. Rs. 25/- will be charged for each copy. Request for additional /duplicate copy should be made in writing by site in charge or higher officers of the user department.
- v) Field Density test shall be taken in Asphalt concrete Carpet for any thickness. The Contractor shall obtain the intimation letter from Engineer-in-charge & furnish the same to A. E. (Soil Mech.) or as directed by the Engineer within 7 days from the date of laying of asphalt concrete for carrying out the field density test. For any neglect or delay on the part of the contractor to intimate the same within seven days period, the additional charges as penalty would be recovered from the Contractor up to Rs. 200/- per test per week at the time of submission of intimation to A.E (Soil Mech.)'s office.
- vi) Samples of bitumen cut back, emulsions shall be forwarded in wide mouthed metal containers with label pasted on the lid.
- vii) Samples for tensile testing of reinforcing bars shall be straight for entire length without bends. The ends of the bars shall be hacksaw cut and not chisel cut. One sample of each diameter bar shall be sent for first test and for retest, two bars shall be sent. The length of the bars shall be 50 cm. for all diameters.
- viii) Samples that are sent for testing for natural moisture content, shall be forwarded in wax coated packing or sealed airtight bags.
- ix) Undisturbed samples sent in sampling tube shall be wax coated on both open ends.
- x) The samples thus taken shall sent to the Testing Laboratory within 4 days from the date of laying of Asphalt mix on site. In case of delay, additional testing charges as penalty would be recovered from the Contractor at the following rates.

A)	<i>From the 5th day to 7th day from date of laying of asphalt mix on site</i>	<i>Rs 10,000/-</i>
B)	<i>From the 8th day to 14th day from date of laying of asphalt mix on site</i>	<i>Rs 20,000/-</i>

The above charges i.e. (A) & (B) shall be paid by the contractors at time of submitting the samples in Municipal Laboratory.

If the samples of the Asphalt mixes are not sent for testing within 14 days, payment for the corresponding quantity of those samples shall not be made.

Charges would be recovered from the respective bills payable to the contractor by respective department and credited to XV- Traffic Operations, Roads and Bridges, H - Material Testing Laboratory.

- xi) In case of failure of asphalt mix sample testing in Municipal Laboratory in various tests the following penalties will be imposed.

- a) *Rs500/- for each gradation failure as per result of asphalt macadam, seal coat and asphaltic concrete and Rs 1000/- for each gradation failure in mastic asphalt.*
- b) *For failure on more than 3 gradations in any asphalt mix. 50% of the cost of the work represented by the failed sample will not be paid to the contractors.*
- c) *Rs1000/- each for failure in flow value/Bulk density/Void Ratio/marshall stability in asphaltic mix beyond permissible limit as mentioned in the test report.*
- d) *In case of excess % of bitumen in the bitumen mix beyond specified limit, a penalty of Rs.60/- per MT of AM/SC/AC having excess bitumen for 50MT or thereafter as applicable for which representative sample was taken will be imposed on C/S.*
- e) *In case of less percentage of bitumen in the bitumen mix, than the specified limit, 50% of the cost of day's work represented by the sample will be recovered as penalty.*
- f) *In case of failure of field density of Asphalt mix, the area represented by the sample has to be removed and redone.*

The test of samples of asphalt macadam, asphaltic concrete, mastic asphalt, paver blocks, concrete cubes (28 days) flexural beams used in the work shall be carried out at municipal laboratory or approved laboratory as directed by engineer in-charge.

The site laboratory shall be used for testing of sub-base, GSB, base course, WBM, concrete cubes and other materials as necessary and directed engineer in-charge.

The charges for testing of construction materials and asphalt mixes shall be as per the rates in force at the time of testing of materials/asphalt mixes and the testing charges shall be borne by the contractor.

- xii. Cement samples should be forwarded in sealed airtight container with one opening on top not less than 10 cm. in diameter. Moulds of concrete cubes/beams taken on hire shall be returned in clean, oiled condition with all nuts and accessories in proper position.
- xiii. All the specifications laid down by IRC and as detailed in the relevant clauses of MORTH- (2001) Manual on Specifications for Road and Bridgework should be strictly followed.

10.9 Paver Blocks:

1. All paver blocks shall be sound and free of cracks or other visual defects which will interfere with the proper paving of the unit or impair the strength or performance of the pavement constructed with the paver blocks.
2. The test criteria and material requirements for Paver blocks should adhere to IS-15658: 2006. The salient features are as given below:

Physical Requirements:

- a) All paver blocks shall be sound and free of cracks or other visual defects which will interfere with the proper paving of the unit or impair the strength or performance of the pavement constructed with the paver blocks.

- b) When two layer paver blocks are manufactured there shall be proper bonding between the layers. Delamination between the layers shall not be permitted. The compressive strength of the two layer blocks shall meet the specified requirements.
- c) When paver blocks with false joints, surface relief or projections are supplied, the same shall be specified. Also, the surface features shall be well formed and be devoid of any defects.
- d) The mix design for paver blocks shall be obtained from manufacturers and shall be submitted before commencement of the work.
- e) In case of failure of samples, the corresponding area of paver blocks shall be removed & replaced and samples of replaced lot shall be tested.
- f) Octroi receipt will not be insisted if paver blocks are procured within Mumbai Limit, subject to the submission of documentary evidence.

Thickness of Wearing Layer:

When paver blocks are manufactured in two layers, the wearing layer shall have minimum thickness as specified in the IS. The thickness of the wearing layer shall be measured at several points along the periphery of the paver blocks. The arithmetic mean of the lowest two values shall be the minimum thickness of the wearing layer.

Water Absorption:

The water absorption, being the average of three units, when determined in the manner described in the IS, shall not be more than 6 percent by mass and in individual samples, the water absorption should be restricted to 7 percent.

Tensile Splitting Strength Test:

<i>Sr.No</i>	<i>Thickness of paver blocks</i>	<i>Grade of Concrete</i>	<i>Minimum Tensile splitting strength (Mpa)</i>	
			Individual	Average
i.	50	30	>2.1	>2.2
ii.	60	35	>2.6	>2.8
iii.	80	45	>3.6	>3.9
iv.	100	50	>4.1	>4.5
v.	120	55	>4.6	>5.2

Abrasion Test:

Abrasion resistance for classes of H & I mark Paver blocks is < 20,000 mm³ /5000 mm² (Individual) and <18000 mm³/ 5000 mm² (Average), respectively.

The required number of test for abrasion resistance shall be 1 test for a quantity of **2,00,000**paver blocks.

Sampling:

The required number of blocks shall be sampled from each batch of the consignment of blocks upto a quantity of 25,000 blocks.

<i>Sr.No</i>	<i>Property</i>	<i>Number of paver blocks for Test</i>
i.	Water absorption	3
ii.	Compressive strength	8
iii.	Tensile splitting strength	8
iv.	Abrasion resistance	8

All Materials used on site shall be adequately tested as per testing frequency mentioned in this tender / Municipal Specifications in force. No payment shall be made for untested materials used on site.

Compressive Strength:

Compressive Strength of paver blocks shall be determined as per the method given in the IS. Paver block strength shall be specified in terms of 28 days compressive strength. In case the compressive strength of paver blocks is determined for ages other than 28 days, the actual age of testing shall be reported. The average 28 days compressive strength of paver blocks shall meet the specified requirement. Individual paver blocks strength shall not be less than 85 percent of the specified strength. In case blocks of age less than 28 days are permitted to be supplied, correlation between 28 days strength and the strength at specified age for identified batch/mix of blocks shall be established.

The specified average 28 days compressive strengths of different grades of paver blocks are given in the table below:

Compressive Strength Requirements of Concrete Paver Blocks:

<i>Sr.No</i>	<i>Grade of Paver Blocks</i>	<i>Minimum Average 28 days compressive strength N/mm²</i>
<i>1</i>	<i>2</i>	<i>3</i>
i.	M30	
ii.	M35	fck + 0.825 x established standard
iii.	M40	deviation (rounded off to nearest 0.5 N/mm ²)

10.10 Maintenance Works:

- 1) The defect liability period shall be as per Annexure 'A'. The contractor shall be liable to maintain the completed works during the defect liability period, which shall include any repairs, rectification of any part or portion of the project road immediately without waiting for any notice or intimation and shall include:
 - a) maintaining roads signs, road markings, arrow marking etc. throughout the year, If applicable.
 - b) Maintaining the kerbs, dividers, with proper painting twice in a year preferably before and after monsoon, jointing etc, If applicable
 - c) All road side furniture shall be inspected, restored/painted, If applicable to original condition.
 - d) Surface deteriorations shall be rectified.
 - e) Paver blocks- the undulations in the paver blocks settlement of paver blocks, broken pieces of paver blocks shall be rectified/replaced as directed.
 - f) The contractor shall not be entitled for any additional cost for such works undertaken.

g) sealing of the joints of concrete pavements shall be done once a year, prior to monsoon.

2) Prescribed period for completing the maintenance works shall be as under:

a) Deteriorated surfaces in Asphalt, Paver Blocks that affect the movement of traffic shall be repaired / rectified within 24 hrs. of notice of such defects by the contractor in his default or when brought to his notice by concerned staff of M.C.G.M.

b) All other maintenance work like Road signs, Lane marking, railing etc. if found defective, shall be started within 7 days of notice of such defects by the contractors and completed within a reasonable period of 4 weeks or period as directed by Engineer whichever is earlier.

c) Filling of potholes or patching up should be taken and completed with 24hrs. of issue of instructions to do so.

Penalty of Rs 2500/- per day for every day of delay beyond period prescribed in the tender shall be levied as regards the maintenance works.

3) It will be the responsibility of the contractors to arrange for a joint inspection in every quarter of the year after completion of the work till the expiry of defect liability period and also 4 weeks before expiry of the defect liability period. Further, if the contractor fails to do so, the observations made by the staff during site inspection will be considered for the purpose of noting the defects.

10.11 Settlement of Disputes / Arbitration and Jurisdiction

The procedure shall be as per clause no 13 d and 13 e of the G.C.C w.e.f 01.06.13. or as amended by the M.C.G.M from time to time.

10.12 Special clause for Cement Concrete / Asphaltting Road works

The tenderer must comply with following machinery for execution of the tender work as per M.C.G.M's Road department's ongoing policy and take the same into account while quoting their percentage:

<i>Particulars</i>
Intelligent Compaction system - compatible for L&T, Escort, JCB, Greaves make Compactors
Agent Software for Compactor
Batch Mix Plant Scada Automation
Software Agent Batch Mix Plant connectivity
RMC plant Automation with SCADA
Software agent RMC plant connectivity
Vehicle Tracking System with automation loading unloading Switch
Vehicle Tracking System Per month Subscription charges
SCADA automation for ICPB factory.

10.13 Urban Tree & Paving:

While executing the work the bidder has to protect the trees as per Urban Trees and paving Guidelines, copy of which is available with the office of Ch.E.(Rds.,Tr.&Br.) .

10.14 Directions for use of GGBS

1. Granulated slag used for manufacture GGBS shall conform to IS:12089
2. Ground Granulated Blast Furnace Slag (GGBS) to be used as cementations material shall conform to BS 6699.
3. Cement used by RMC/ Contractors shall conform to OPC/ Portland Slag Cement conforming to IS: 455.
4. In case of site mixing, a blend of 40% GGBS and 60% OPC 43 grade shall preferably be used.
5. The mixture of cement containing GGBS and OPC shall conform to IS:455 for chemical parameters.
6. RMC plants shall submit Manufacturer's test certificate of GGBS every week.
7. RMC plants shall submit certificate of physical testing of cement mixture twice a month and chemical testing of the same before its use.
8. To cover durability parameters of concrete, R.M.C. plants shall submit one report during the project on permeability test (RCPT as per ASTM 1202) and heat of hydration of cement mixture determined at 7 & 28 days from the Laboratories approved by Chief Engineer (Roads & Tr.)

10.15 Directions for use of Fly ash

1. I.S.I mark fly ash conforming to IS 3812 shall be used 20% by weight of cement.
2. Test certificate from Manufacturer shall be produced for satisfying physical and chemical test properties as per IS 3812 before the use and for every batch of fly ash.
3. A separate silo shall be provided for stacking fly ash in the R.M.C. Plant.

10.16 Directions for use of Micro silica

1. I.S.I. Micro silica confirming IS:15388:2003 shall be used not more than 10% by weight of cement.
2. Test Certificate from Approved Manufacturers shall be produced for satisfying physical and chemical test properties as per IS 3812 before the use and every bath of Micro silica.
3. A separate silo shall be provided for stacking micro silica in the RMC plant.

TABLE1: INDIAN STANDARDS (IS and IRC) FOR CONCRETE PAVEMENT CONSTRUCTION AND QUALITY CONTROL

I – MATERIALS

	<i>Specification</i>	<i>Method of test</i>	<i>Sampling</i>
Cement	IS: 8112 (Gr.43) IS:12269(Gr.53) Or Relevant IS	IS: 4031 (Pt.1 to 14) IS: 4032 or Relevant IS	IS: 4879 or Relevant IS
Aggregate coarse & Fine	IS: 383	IS:2386 (Pt. 1 to 8)	IS: 2430
Water	IS: 456		
Admixture for concrete	IS: 9103		
Hot applied sealing compound for joints	IS: 1834 of 1984		
Concrete mix design	IS: 10262 IRC: 44 IRC: 59		
Concrete strength		IS: 516	
Ready - mixed concrete	IS: 4926		

I - CONSTRUCTION

	<i>Specification</i>	<i>Method of test</i>	<i>Sampling</i>
Construction of concrete pavement	IRC: 15		
Lean cement concrete base/ subbase	IRC: 74		
Curing cement concrete pavement	IRC : 84		
Installation of joints in concrete pavement	IS : 6509		
Sealing of joints in concrete pavements	IS : 1834 IRC : 57		

TABLE 2 : MINIMUM TEST FREQUENCIES FOR QUALITY CONTROL OF CONCRETE ROAD CONSTRUCTION

I- MATERIALS

<i>Item</i>	<i>Test</i>	<i>Control Criterion</i>	<i>Frequency</i>
Cement	Physical and chemical test	Relevant IS	Once for each source of supply for approval of the source and subsequently for every batch.
Coarse & fine aggregates	--do- (including soundness & alkali reactivity)	IS : 383	Once for each source
Water	Chemical Test	IS : 456	--do---
Expansion	Jt. Filter board	IS : 1838	--do---
Jt. Sealing compound		IS : 1834 of 1984	--do---
10/20 Grade Bitumen	Physical		--do---

DURING CONSTRUCTION:

MATERIALS :

Cement	Strength	IS : 8112	for each lot of cement received
Coarse & fine aggregate	Gradation	IS : 383	Regularly as required
	Moisture Content	--do---	Regularly as required subject to a minimum of tests per day.
Coarse aggregate	Los Angeles Abrasion Value		Once for every change of source.
	Aggregate impact value Specify gravity	IS : 383	--do---
Flakiness Index		--do---	--do---
Elongation Index		--do---	--do---

<i>Item</i>	<i>Test</i>	<i>Control Crite- rion</i>	<i>Frequency</i>
<u>CONCRETE</u>			
Workability			One per transit mixer
Concrete strength			Beam / Cube samples, as specified for each age of 7 days, 14 days and 28 days for every days
Checking surface evenness with 3 mt. straight-edge and wedge gauge			Three longitudinal lines along with the slab length - one in the end middle - third end the two edge third strips, along the line of maximum unevenness.
<u>DOWEL BARS</u>			
Alignment (being in a plane parallel to the surface of the base course and being also parallel to the center line of the slab).			Each dowel bar, after fixing in position.
TIE BARS			
Mid -height positioning			Each tie bar

TABLE: 3 ADDITIONAL QUALITY CONTROL CRITERIA AND TOLERANCES

<i>Position</i>	<i>Criteria</i>	<i>Tolerance</i>
Sub grade/ Sub base under Lean Concrete base	Full compaction K-Value 5.5 kg/m ³ or C.B.R. 10	No minus tolerance
Lean Concrete base	Grade: M-10	Tolerance level for characteristic strength assessment 1 in 40
	Surface unevenness under 3 M straight edge Curing : 7 days or till laying of concrete slab in case the slab is laid earlier but not earlier than 24 hours.	Not more than 10 mm

<i>Position</i>	<i>Criteria</i>	<i>Tolerance</i>
Cement concrete pavement	Grade: M35 & above Workability 50 mm (slump) maximum	Tolerance level for characteristic strength assessment: 1 in 40 +/- 10 mm
	Curing: 14 days cure by ponding with water. Curing on the day of casting (prior to curing by ponding) shall be done with wet hessian cloth and curing compound	No tolerance
Dowel Bars	Length and dia. Placement with equal length vis-à-vis center line of the joint Horizontal & Vertical alignment including that of dowel cap.	Should not be smaller than stipulated value ± 4.5 mm

TABLE:4 MINIMUM TEST FREQUENCIES FOR QUALITY ASSURANCE / ACCEPTANCE OF CONCRETE ROAD CONSTRUCTION

Parameter	(M-10) Lean Concrete Base	(M-15) & above Cement Concrete Pavement
Strength (core testing)		12 nos. of 150 mm dia. cores as specified in relevant clauses. Acceptance criteria as per I.S. 1199 and I.S. 516, only for thickness of concrete is more than 20 cm
Surface evenness	3 longitudinal lines (as for quality control)	3 longitudinal line (as for quality control) as specified in relevant clauses
Surface defects	Full surface	Full surface

TABLE: 5 ACCEPTANCE CRITERIA

Parameter	On completion, Before/within two months of opening to traffic	At the end of Defect liability period of 5 years
Strength	“Characteristic strength for cubes tested at the age of 28 days analyzed for complete work to exceed the specified strength”. Individual core strength test results, corrected for age, H/D ratio & shape (cylinder to cube) upto the specified strength. The characteristic strength (28 days) to be not less than the specified strength (for a tolerance level of 1 in 40).	Before the end of the defect liability period, the site will be jointly inspected along with the contactor's representative/ Engr. & defects observed will be listed & the necessary rectification will be carried out as directed by Ch Engr. (C.C. Roads & Tr.) in accordance with the relevant specifications & clauses mentioned in Special Directions/ Conditions to the Tenderers.

ANNEXURE : I

SEALING OF JOINTS IN RIGID PAVEMENTS

The sealing of joints in rigid pavements shall be accomplished with the use of appropriate grade of sealing compound (IS:1834-1984). The sealing compound shall be heated to required temperature before filling into the joint.

(A) **Materials:**

- (i) Sealing compound conforming to IS : 1834
- (ii) Primer conforming to IS 3384

(B) **Physical requirements of sealing compounds of Grades A & B -**

Table 1 of IS 1834 – 1984

<i>Sr. No</i>	<i>Characteristic</i>	<i>Requirement</i>	<i>Method of Test</i>	<i>Remarks</i>
(i)	Pour Point. Max	180° C	Appendix A	Grades A & B
(ii)	Flow Test, Percentage Max	5	Appendix B	Grades A & B
(iii)	Extensibility, Min.	6 mm	Appendix C	Grades A & B
(iv)	Penetration at 25° C, 100g. 5s, 1/10	15 min. 50 max.	IS 1203 - 1978	Grades A & B

<i>Sr. No</i>	<i>Characteristic</i>	<i>Requirement</i>	<i>Method of Test</i>	<i>Remarks</i>
(v)	Aviation fuel resistance a) Increase in penetration as measured in (iv) after 7 days immersion in aviation fuel (See IS : 1571 - 1982 †) Max 15 b) Changes in mass after 7 days immersion in aviation fuel, percent max	Max 15 1	Appendix D & IS : 1203 1878 * Appendix E	Grade B only Grade B only
	* Methods for testing tar and bituminous materials : Determination of penetration (first revision) † Specifications for aviation fuels, kerosene type (fourth revision)			

10.17 Procedure for filling the joints:

- i) The delivery challans for joint sealing compound shall bear requisite details, such as serial nos., Batch no., Date, weight, and name of the contractor to whom the sealing compound is being supplied etc. The manufacturer's Test Certificate to the effect that sealing compound conforms to relevant I.S. Specifications, shall invariably accompany the every consignment of sealing compound, brought on site.
- ii) Due care shall be taken to see that temperature is carefully controlled while heating the joint sealing compound. Due precaution shall be taken to avoid the overheating of joint sealing compound above 180 degree cent., as well as heating for long periods since sealing compound will lose the rubberized properties due to overheating. In case of default on this account, entire overheated material will be rejected. Therefore quantity of sealing compound required for only one operation of joint sealing work, shall be heated.
- iii) Joint sealing compound once heated but not utilized will not be permitted for use after reheating the same and such material will be discarded and will have to be removed from the site
- iv) When sealing work is in progress, wooden battens shall be placed on either sides of the joints or suitable arrangement shall be made to prevent erratic flow of the compound.
- v) The contractor should take due care to ensure that the fumes/smoke emitted due to heating of filling materials shall not affect the nearby residents, where the work is in progress.
- vi) The existing sealing compound in machine cut joint shall be removed completely with raker and coir brush up to a depth of 40mm and joint faces shall be thoroughly cleaned. The dust in the joint shall be blown off with compressed air from blower.
- vii) After the joint surface has thoroughly dried, primer shall be applied to the cleaned joint in thin film by brush.

viii) As soon as primer attains 'touch dry' state, sealing compound heated to appropriate pour point temperature @ 160-180 degree cent shall be poured in two stages in such manner that the material does not spill over the exposed concrete surface. Due precaution shall be taken to avoid overheating of joint sealing compound over 180 degree cent. as well as heating for long periods since sealing compound is liable to be damaged due to overheating.

ix) After the sealing compound is cooled to ambient temperature, it shall be cut with hot spatula to bring it flush with the existing concrete surface. The finished surface shall be dusted with lime powder to prevent any damage likely to be caused on account of traffic movement.

10.18 PENALTY CLAUSE

The Engineer not below the rank of Assistant Engineer is entitled to impose a penalty of Rs 5000/- per day/lapse, in accordance to the gravity of default communicated in writing. Penalty amount will be recovered from contractors running bill.

If it is observed that, the contractor carrying out the work fails to comply with the instructions given by the authorities of the Dy.HE (Const)/H.E/D.M.C (SE) /A.M.C/M.C.'s level during execution of work twice, the work may be terminated and will be carried out at the risk and cost of the contractor and penal action will be taken against them. This decision will not be arbitrable at all.

The above mentioned condition will be in addition to the relevant condition in the General Condition of contract regarding cancellation of contract in full or partly final decision of disputes, difference of claims raised by the contractor or relating to any matter out of contract.

Penalty shall be levied & recovered from contractors running bills as stated below.

In case of failure of asphalt mix sample testing in Municipal Testing Laboratory in various tests the following penalties will be imposed.

Sr.No	Particulars	Penalty
1	<i>Gradation Failure in asphalt macadam(AM), asphalt concrete(AC), seal coat(SC)</i>	Rs500 / -
2	<i>Gradation failure in mastic asphalt (MA)</i>	Rs1000 / -
3	<i>Failure on more than three(3) gradations in AM,AC,MA</i>	50% of the cost of the work done representing the sample
4	<i>Failure in flow value, bulk density, void ratio, marshal stability</i>	Rs1000 / -
5	<i>Excess bitumen content beyond specified limits</i>	Rs150 / - per M.T for the work representing the sample.
6	<i>Less percentage of bitumen content in asphalt mix/es.</i>	50% of the cost of work representing the sample.

10.19 Other penalties

In addition to any penal action under the General Conditions of Individual contracts, a registered contractor will be liable under the registration rule to one or more of the following penalties:

- a) Warning / Fine
- b) Demotion
- c) Deregistration

a) **Warning / Fine**

A contractor will be liable to a warning and /or penalty for:

- i) Non-compliance of any provision of the rules.
- ii) Failure to comply with any clause or direction under these rules or comply with any conditions of tenders / contracts.

A) Inadequate progress / performance under the contract.

For the first default of any type mentioned above a warning will be issued. For each subsequent default of the types in (i) & (ii) above the minimum penalty will be fine of **Rs 2500/-** while that for a default of the type (iii) the minimum penalty will be **Rs 5000/-** for contracts of upto Rs 25 Lakhs and **Rs 10000/-** for contracts of above Rs 25 lakhs. Higher Amount of penalty may be levied by the competent authority for reasons to be recorded.

b) **Demotion**

A contractor will be liable to be demoted to a lower class of registration on any of the following grounds:

- a) specific failure or default in execution of individual works in respect of physical progress for quality of such works.
- b) Inadequate performance as revealed by quarterly performance report.
- c) Deterioration in financial or technical ability /capacity.
- d) Repeated failure to fill in tender documents fully and correctly or delay in execution of formal contract documents.

c) **Deregistration:**

A contractor will be liable to be deregistered on any of the following grounds.

- a) Attempt to defraud the Corporation.
- b) Attempt to bribe any employee / officer of Corporation.
- c) Attempt to secure a contract through unfair means or by bringing to bear outside influence.

- d) Attempt to secure unauthorized copies of Municipal Records, any documents in relation to any tender / contract or any other official matter.
- e) Furnishing or tampered with Municipal record and documents.
- f) Furnishing false and / or misleading information to registration and / or any tender / contract.
- g) Threatening, Misbehaving with or physical attack on any Municipal Employees / officer.
- h) Attempt to instigate or collude with other contractors with a view to securing undue advantage.

Tenderers are requested to take cognizance of Child Labour Act and shall not employ child Labourers on site. If Child Labour is found to be employed on the work, a penalty of Rs 5000 / - on the spot will be imposed on the defaulting contractors and further action as deemed fit will be taken.

10.20 List of Approved Asphalt Plants for Supplying Asphalt Mixes to works of M.C.G.M.

The asphalt mixes required for any works of M.C.G.M. shall be supplied by the listed approved asphalt plants only. Tenderers shall arrange to bring the asphalt mixes from these approved asphalt plants registered with M.C.G.M during the period of work. The valid list of approved asphalt plants can be obtained from the Dy.Ch. Eng. (Roads) City's office at the time of execution of work. The contractor shall ensure the validity of registration certificate of Asphalt Mix before receiving the Asphalt Mix

10.21 List of Approved Manufacturers of Interlocking Paver Blocks

Sr. No	Name and Address of Plant	Location of Plant
1	M/S. Conwood Pre Fab Pvt. Ltd. Conwood House, Yashodham, General A.K. Marg, Goregaon (E), Mumbai:400063. (Off.):28402304	Palghar Manor, Dist. Thane.
2	M/S. Unitech Prefab Ltd., Unit 11 &12, Nahar & Sheth Ind. Premises, Andheri (E) Mumbai: 400090. (Off.):26910055/26910057/ 26910058	Taloja
3	M/S. Rina Cement Product, 14-B, Ranjit co-op Hsg. Soc., Sarojini Naidu Road, Mulund (W), Mumbai:400080. (Off.):2560191 Mob. No. 9820255507	
4	M/S. Super Tiles & Marbles Pvt. Ltd., 4-5-6, Mehta Marg, D.S.P., Dadar (E), Mumbai: 400014. (Off.):24137627 Fax no. 91-22-24140158.	
5	M/S. Prayosa Buildmet Pvt. Ltd., 202, Vastu Building, Kolbad Naka, Opp. Babubhai Petrol Pump, L.B.S. Marg,	

10.22 List of manufacturer of interlocking paver blocks registered with M.C.G.M

Contractor shall arrange to bring paver blocks from above approved plants registered with M.C.G.M., during the execution of the work:

The valid list of approved paver blocks manufacturers plants at “the time of execution of works” to be obtained from the Dy.Ch.Engineer (Roads) City's office.

The contractor shall ensure the validity of registration certificate of paver blocks plant before receiving the paver blocks.

10.23 List of Approved RMC Plants registered with M.C.G.M

Contractor shall arrange to bring paver blocks from approved plants registered with M.C.G.M., during the execution of the work. The valid list of approved paver blocks manufacturers plants at “the time of execution of works” to be obtained from the Dy.Ch. Eng. (Roads) City's office. The contractor shall ensure the validity of registration certificate of paver blocks plant before receiving the paver blocks.

10.24 LABORATORY REGISTERED WITH M.C.G.M

The updated list at the time of execution of works can be obtained from the Dy.Ch.Eng. (Roads) E.S.'s office.

Note: The tests to be carried out in the above laboratory shall be restricted to max. 20% per project.

10.28 List of Approved Manufacturers

A) D.I. PIPES

- I. Electro steel Castings Ltd (Madras / Calcutta) “Electro spun”
- II. JINDAL
- III. LANCO
- IV. ELECTROTHERM INDIA LTD

D.I pipe to be manufactured as per the following specifications:

I.S 8329 of 2000: I.S.O 2531 of 1998 (Each pipe shall bear ISI mark on it).

B) C.I. SPECIALS

- I. Eskay Industrial Enterprises (Calcutta) “Eskay”
- II. Kamala Valves Manufacturing Concern (Calcutta) “Kumc”
- III. Damodar Iron Works (Belgaum)
- IV. Popular Tube Well & Rubber Industries (Calcutta) “BLATBA”

Any other make having I.S.I. Mark subject to approval of the Engineer of the contract and

physical verification of the product in manufacturing place in the factory. Choice of selection will remain with the Engineer of the contract.

C) BUTTERFLY VALVES

- I. M/S VENUS : (upto 1200 mm dia and 16 bar PN rating)
- II. M/S R & D Multiple: (upto 1200 mm dia and 16 bar PN rating)
- III. M/S KAMALA : (upto 600 mm dia and 10 bar PN rating)

D) AIR VALVES

- I. M/S AMFLOW Technology:(upto 200 mm dia 16 bar PN rating)
- II. M/S BIKANER : (upto 200 mm dia 16 bar PN rating)

E) SLUICE VALVES

- I. M/S AARKO : (upto 300 mm dia and 10 bar PN rating)
- II. M/S KAMALA : (upto 300 mm dia and 10 bar PN rating)
- III. M/S BIKANER : (upto 300 mm dia and 10 bar PN rating)
- IV. M/S PATSONS : (upto 300 mm dia and 10 bar PN rating.)

F) GLANDLESS SLUICE VALVE

- a. M/S AARKO : (upto 300 mm dia and 10 bar PN rating)
- b. M/S KAMALA : (upto 300 mm dia and 10 bar PN rating)
- c. M/S BIKANER : (upto 300 mm dia and 10 bar PN rating)
- d. M/S PATSONS : (upto 300 mm dia and 10 bar PN rating.)

The above list is as per circular No. AE (M) WW/ 2003/ City dated 7.7.2007 and will remain APPLICABLE till completion of work.

G) STAND POST FIRE HYDRANT

The stand post fire hydrant shall be used as accepted and tested by M.C.G.M i.e. Asstt.Engineer (E.R.C). The present name of company accepted by Asstt. Engineer(E.R.C) are as under:

- a. M/S AARKO
- b. M/S KAMALA
- c. M/S KARTAR

10.25 SCHEDULE OF FEES FOR TESTING

At Municipal Material Testing Laboratory. Rates of testing fees and quantity of sample for test as approved under no. MGC/F/5749 of 12.08.2011 or applicable as amended from time to time.

<i>Sr.No</i>	<i>Description</i>	<i>Reference/ Standard</i>	<i>Rate in (Rs) / Test</i>	<i>Quantity of samples re- quired</i>
A	Aggregate (Coarse& Fine)			
1	Sieve Analysis (dry)/Fineness modulus	IS 2386:Part I-1963,IS 383-1970 MORTH 4th Revision,2001	400/-	20 Kg
2	Silt Content		500/-	2 Kg

3	Specific Gravity	IS 2386:Part III-1963	450/-	1 Kg
4	Impact Test	IS 2386:Part IV - 1963 MORTH 4th Revision, 2001.	500/-	10 Kg
5	Crushing Value/ 10% Fine Value		600/-	10 Kg
6	Los Angeles abrasion Value		900/-	10 Kg
7	Water absorption	IS 2386 : Part III - 1963, MORTH - 4th Revision,2001	450/-	1 Kg
8	Flakiness Index	IS 2386 : Part I - 1963, MORTH - 4th Revision,2001	400/-	10 Kg
9	Elongation Index		400/-	10 Kg
10	Combined Flakiness & Elongation Index		800/-	20 Kg.
B	Asphalts			
11	a) Asphalt Macadam/Bituminous Macadam, Asphalt Mixes (Extraction & gradation)	IRC 27 - 1967, MORTH - 2001	770/-	7 Kg. See Note - 2
	b) Seal Coat (Extraction & gradation)	Specification MORTH – 2001	770/-	3 Kg. See Note – 2
		Specification		
12	Binder Course (Extraction & gradation, Density, Voids)		1100/-	7 Kg. See Note – 2
13	Asphalt Concrete/Bituminous Concrete/Dense Bituminous Macadam, Semi Dense Bituminous Concrete /Polymer Modified Binder(PMB)/Crumb Rubber Modified Binder(CRMB)(Extraction, Gradation, Density, Voids, Flow Value ,Marshall Stability	IRC 29, MORTH - 2001, IRC-SP-53-1999	1950/-	7 Kg. See Note – 2
14	Mastic Asphalt (Extraction & gradation, hardness no)	IS 5317-1987, IS 1195-1978	1000/-	2 specimen each of 10 cm dia or 10 cm ² 2.5/thick cm
15	Field Density of Asphalt Mixes/Soils	IS 2720 : Part 28, 1974 (Reaffirmed 1995)	1100/- for first test and Rs 550/- for each addl. Test	
16	Specific gravity of bitumen	IS 1202-1978	550/-	2 Kg. See Note – 8
17	Penetration test of bitumen	IS 1203-1978	550/-	2 Kg. See Note – 8
18	Softening point of bitumen	IS 1205-1978	770/-	2 Kg. See

				Note – 8
19	Job mix formula for Asphaltic mixes	Asphalt Institute Manual MS-2	10000/-	(25 Kg. C.A., 25kg F.A., 10kg filler, 5kg bitumen.)
20	Presence of antis tripping agent	CRRI Specification	450/-	(1 Kg. Bitumen from plant (Sealed)
21	Effectiveness of antis tripping agent		770/-	1 Kg. in wide mouth bottle
22	Ductility test of bitumen	IS 1208-1978	770/-	1 Kg. in wide mouth bottle
23	Flash Point & Fire Point	ASTM	450/-	1 Kg. in wide mouth bottle
24	Loss of heating, Thin Film Oven Test	IS 1212	770/-	1 Kg. in wide mouth bottle
25	Elastic recovery of half thread in Ductilometer at 15°C on PMB/CRMB	IRC : SP : 53 : 2002	770/-	1 Kg. in wide mouth bottle
C	Soils			
26	Specific Gravity	IS 2720 : Part 3 - 1980	450/-	1 Kg
27	Bulk Density		280/-	2 Kg
28	Natural moisture content	IS 2720 : Part 2 - 1973	220/-	2 Kg. See Note – 9
29	Liquid limit	IS 2720 : Part V – 1985	400/-	10 Kg
30	Plastic limit		400/-	10 Kg
31	Void ratio (Denity& Sp.Gravity		400/-	
32	Standard Proctor Test	IS 2720 : Part 7 - 1980	1100/-	20 Kg
33	Modified Proctor Test	IS 2720 : Part 8 - 1980	1100/-	20 Kg
34	Laboratory C.B.R Test	IS 2720 : Part 16 -1987	1650/-	25Kg
35	Dry Sieve Analysis	IS 2720 : Part 4 - 1985	330/-	25Kg
36	Fiend C.B.R Test	IS 2720 : Part 31 -1990	1100/- for first test and Rs 550/- for each addl. Test	
37	Safe.Bearing.Capacity.	1100/- for first test and Rs	

			550/- for each addl. Test	
38	Energy criteria Test for piles	1100/- for first test and Rs 550/- for each addl. Test	
D	BUILDING MATERIALS			
	Cement			
39	Cement (Initial & Final Setting time, Compressive Strength)	IS269,IS 8112, IS 12269	1400/-	7 Kg. See Note – 6
	Bricks			
40	a)Bricks(Set of Ten) (Compression Test & Absorption Test)	IS 1077-1986	1000/-	10 Nos
	Steel			
41	Steel bars (6mm dia to 20 mm dia)(Area on weight basis, Yield Stress/0.02% Proof Stress, Ultimate Tensile Strength, % Elongation	IS 432- 1986 IS 1786-2008	900/-	60 cm see note 1(c),7.
42	Steel bars (Above 20 mm dia)(Area on weight basis, Yield Stress/0.02% Proof Stress, Ultimate Tensile Strength, % Elongation	IS 432- 1986 IS 1786-2008	1100/-	60 cm see note 1(c),7.
	Concrete			
43	Concrete Cube (Compressive Strength)	IS 456-2000, IS 516-1959	450/-	3 Nos see Note 1(c)
44	Concrete Beam (Flexure Test) (10 x 10 x 50 cm)	IS 456-2000, IS 516-1959	600/-	3 Nos see Note 1(c)
45	Concrete Beam (Flexure Test) (15 x 15 x 70 cm)		600/-	3 Nos see Note 1(c)
	Tiles			
46	Tiles (Abrasion Test)	IS 1237-1980,IS 13801-1993	550/-	6 Nos for each Test
47	Tiles (Wet Transverse Test)	IS 1237-1980, IS 13801-1993	550/-	6 Nos for each Test
48	Tiles (Abrasion Test)	IS 13603 part 12-1993	1100/-	See Note 14
	Wood			
49	Wood (Moisture content)	IS 287-1993 (Reaffirmed 1998) IS 11215-1991	450/-	See Note 13
	Cores			
50	C.C.Road Core (Compression Test)	IS 456-2000, IS 516-1959	2200/- Per Core	
	R.C.C Covers			
51	R.C.C.Cover & Dhapa Testing	IS 12592 : Part I , 1998	450/ Each.	
	R.C.C.Pipes (Hume Pipes)			

52	Hume pipe testing	IS 3597-1998 (Reaffirmed 2001), IS 458-1988		
	a) Upto 600 mm dia		1950/- Per Pipe	Minimum One pipe of Each dia per Lot
	b) 600 to 900 mm dia		2200/- Per Pipe	
	c) 900 mm & above		2500/- Per Pipe	
	Concrete Paving Blocks			
53	Paver Blocks (As per Road Dept. re- quirement)			
	a) Compression test	BS 6717-1993 ASTM C936 IS 1237 BS 6717- 2001	420/-	Upto 3 Nos
	b) Water absorption test		500/-	---- do ---
	c) Flexure test		450/-	---- do ---
	d) Tensile Splitting test		450/-	---- do ---
	Paver Blocks (As per Road Dept.requirement)			
54	a) Water absorption test	IS-15658-2006	550/-	3 Nos
	b) Compression test		1100/-	8 Nos
	c) Flexure test		1100/-	8 Nos
	d) Tensile Splitting test		1100/-	8 Nos
	e) Abrasion Test(Dry Condition)		1100/-	See note no 19
55	Other Charges			
	Duplicate additional copy of test report not older than 5 Years		30/- Per Copy	

Notes:

1. All requests for testing of samples must be made in writing in duplicate, specifying therein the following information (separate memo should be sent for cement concrete, steel, soil, asphalt, etc.)
 - a) Name of the work, work code number if any
 - b) Type of Material and tests desired (i. e. grade of cement, date of Consignment.
 - c) Identification mark on the sample should be mentioned on the forwarding memo (in case of concrete beams and cubes identification mark, grade of concrete, date of casting, specimen no. etc. should be engraved on concrete. If these details are marked by paint, samples will not be accepted. In case of reinforcing bars, details shall be displayed on label pasted on bar and label must be signed by the officer who has taken samples.
 - d) Name and full postal address of the officer to whom test result is to be sent.
 - e) Date of sampling (i.e. date of laying Asphaltic mix, Sr. no of Load,name of supplier/ asphalt plant from where asphalt mix is acquired, casting concrete or taking samples.

- f) Name of the contractors carrying out the work.
 - g) Additional information as per spelt out in Ch. E. (Roads) circular u/no Ch.E/3231/Roads of 07/09/2006, in case of Asphalt Mixes.
 - h) Any other information which is specified by the user department
2. Samples must also bear the identification mark and signature of Site in-charge/ officer taking the sample. in case of samples of asphaltic mixes sent in polythene bags, a legible-duplicate tag should be stapled from outside.
 3. Quantity of sample must be adequate as shown in schedule and the specification with which the samples is to be tested shall be clearly mentioned on forwarding memo by the site in-charge.
 4. Full testing fees shall be paid in advance between 10:30 a.m.and1 p.m. on working days except Saturday and between 10:30a.m. and 12 noon on Saturday.
 5. For issuing additional copies or duplicate copies, Rs.30/- will be charged for each copy. Request for additional duplicate copy should be made in writing by site-in-charge or higher officers of the user department.
 6. Cement samples should be forwarded in sealed air tight container with one opening on top not less than 10 cm. in diameter.
 7. The steel Samples for tensile testing of reinforcing bars shall be straight for entire length without bends. The ends of bars shall be hack saw cut and not chisel cut. One sample of each dia. bar shall be sent for first test and for rested, two bars shall be sent. Length of the bars shall be 50 cm. for dia. less than 25 mm, and 60 cm for dia equal to and greater than 25 mm.
 - 8) Samples of bitumen, cutback, and emulsions shall be forwarded in wide mouthed metal containers with labels pasted on the lid.(at least 2 ltr. Capacity metal container)
 - 9) Samples sent for testing natural moisture content shall be forwarded in wax coated packing or sealed airtight polythene bags.
 - 10) The quantity of Bitumen, cut back, emulsion samples should be at least 2 litre.
 - 11) The sample thus taken shall be sent to municipal testing laboratory as per the condition mentioned in the relevant tender. The samples thus taken shall be sent to the municipal testing laboratory within4 days from the date of laying of Asphalt mix on site. In case of any delay, additional testing charges as penalty would be recovered from the Contractor at the following rates.

<i>A</i>	<i>From the 5th day to 7th day from date of laying of Asphalt mix on site</i>	<i>Rs 10000/-</i>
<i>B</i>	<i>From the 8th day to 14th day from date of laying of Asphalt mix on site</i>	<i>Rs 20000/-</i>

The above charges i.e. (A) and (B) shall be paid by the contractors at the time of submitting the samples in municipal laboratory.

As per tender conditions, additional testing charges as a penalty, towards delay in submission of samples, if any, over and above (A) and (B) mentioned above, would be recovered from the contractors bills by the respective user department and would be credited to the following budget head and voucher no. and date shall be intimated to A.E (Soil Mech)

If the samples of the asphalt mixes are not sent for the testing within 14 days, payment for the corresponding quantity with reference to these samples, shall not be made. The charges would be recovered from the respective bills payable to the contractors by the respective user department and credited to the following budget head.

Fund code : 11
Department code :44
Cost center name : Material Testing Lab.
Cost center code :1000442501
Account head penalties and fines :
Account heads code : 140200200.

- 1) Field density test shall be taken on Asphalt concrete carpet for any thickness. The contractor shall obtain the intimation letter from Engineer-in-charge and furnish the same to A.E.(soil mech.) within 7 days from the date of laying of Asphalt concrete, for carrying out the field density test. If the contractors fails to intimate the same within 7 days period the additional charges as penalty would be recovered from the contractor at Rs 200/ per test per week at the time of submission of intimation to A.E (Soil Mech.)'s office.
- 2) Sample of wood: As per I.S 11215-1991, clause no. 4.2.3.
- 3) The test specimen shall be set of 6 pieces of size 70.6 mm x 70.6 mm, centrally cut from ties and all corners shall be perfectly diagonal.
- 4) Sample shall be carefully brought and unloaded at Lab without any defects.
- 5) The samples taken for cubes and Beams shall be sent to Municipal testing lab at least two days before the actual date of testing. In case of delay additional testing charges as penalty shall be recovered from the contractors at following rates.
 - a) 100 % additional testing charges per week shall be recovered other than concrete road works.
 - b) For concrete road work Rs 500 per day will be recovered as per special conditions/ directions to the tenders for cement concrete road works.

17) R.C.C Covers : No of samples as per I.S. 12592 part – I- 1998.

18) R.C.C Hume pipes : No of samples as per I.S. 458 - 1988.

19) The test specimen shall be of size 71 ± 0.5 mm in square as per I.S 15658- 2006 centrally cut in paver block and all corners shall be perfectly diagonal.

10.26 Specification for Supply of Materials

i. **Bricks:** Bricks used in the works shall conform to the requirements laid down in IS:1077. The class of the bricks shall be as specifically indicated in the respective items of work.

The nominal size of the modular brick shall be 200mm x 100mm x 100mm with the permissible tolerances over the actual size of 190mm x 90mm x 90mm as per IS: 1077. The nominal thickness of one brick and half brick walls using modular bricks shall be considered as 200 mm and 100 mm respectively. In the event of use of traditional bricks of nominal size 230mm x 115mm x 75mm with tolerance up to +3 mm in each dimension, one brick and half brick walls shall be considered as 230 mm and 115 mm respectively.

• **Classification:** Bricks/Brick tiles shall be classified on the basis of their minimum compressive strength as given below :

Class designation	Average compressive strength not less than	Average compressive strength less than
12.5	12.5	15
10	10	12.5
7	7	10
5	5	7
3.5	3.5	5

The bricks shall have smooth rectangular faces with sharp corner and shall be uniform in colour and emit clear ringing sound when struck.

Bricks/Brick tiles shall be classified on the basis of material used and size as given below :

1. Common Burnt Clay Bricks:

Common Burnt Clay Bricks shall conform to IS:1077 and shall be hand moulded or machine moulded. They shall be free from nodules of free lime, visible cracks, flaws warpage and organic matter, have a frog 100 mm in length 40 mm in width and 10 mm to 20 mm deep on one of its flat sides. Bricks made by extrusion process and brick tiles may not be provided with frogs.

Each brick shall be marked (in the frog where provided) with the manufacturer's identification mark or initials.

2. Clay Fly Ash Bricks:

The clay fly ash bricks shall conform to IS 13757. The bricks shall be sound, compact and uniform in shape and colour. Bricks shall have smooth rectangular faces with sharp and square corners. The bricks shall be free from visible cracks, flaws, warpage, nodules of free lime and organic matter, the bricks shall be hand or machine moulded. The bricks shall have frog of 100 mm in length 40 mm width and 10 to 20 mm deep on one of its flat sides. If made by extrusion process may not be provided with frogs. Fly Ash shall conform to grade I or grade II of IS 3812.

3. Tile Brick:

The bricks of 4 cm height shall be moulded without frogs. Where modular tiles are not freely available in the market, the tile bricks of F.P.S. thickness 44 mm (1-3/4") shall be used unless otherwise specified.

4. Brick Bats:

Brick bats shall be obtained from well burnt bricks.

5. Refractory brick:

These bricks should conform to IS:6 and should have size tolerance of variation from specified dimensions, covering both warpage and shrinkage shall be allowed to the extent of $\pm 2\%$ or ± 2 mm, whichever is greater.

The average water absorption shall not be more than 20 percent by weight up to class 12.5 and 15 percent by weight for higher classes. Bricks which do not conform to this requirement shall be rejected. Over or under burnt bricks are not acceptable for use in the works.

ii. Sand :

Natural sand deposited by stream or glacial agencies as a result of disintegration of rock is the best form of sand and shall be used. Sometimes it is obtained from crushed stone screenings but often contains a high percentage of dust and clay. It tends to be flaky and angular. This type produces harsh concrete and should be avoided.

Sand shall be hard, durable, clean and free from adherent coatings and organic matter and shall not contain any appreciable amount of clay. Sand shall not contain harmful impurities such as iron, pyrites, coal particles, lignite, mica shale or similar laminated material, alkali, and organic impurities in such form or quantities as to affect the strength or durability of concrete or mortar. When tested as per IS 2386 Part I and Part II, sand shall not exceed permissible quantities of deleterious materials as given in table 1 of IS 383.

Grading of sand shall conform to IS and shall fall within limits.

iii. Aggregate:

Aggregates shall consist of naturally occurring stones (crushed or uncrushed), gravel and sand. They shall be chemically inert, strong, hard, clean, durable against weathering, of limited porosity, free from dust/silt/ organic impurities/deleterious materials and conform to IS:383. Aggregates such as slag, crushed over burnt bricks, bloated clay ash, sintered fly ash and tiles shall not be used.

1. Coarse Aggregate

Coarse aggregate for concrete, except as noted above and for other than lightweight concrete shall conform to IS 383. This shall consist of natural or crushed stone and gravel, and shall be clean, and free from elongated, flaky or laminated pieces, adhering coatings, clay lumps, coal residue, clinkers, slag, alkali, mica, organic matter or other deleterious matter

- **Screening and Washing**

Natural gravel and crushed rock shall be screened and/ or washed for the removal of dirt or dust coating, if so demanded by the Engineer.

- **Grading**

Coarse aggregate shall be either in single size or graded. In both cases, the grading shall be within the limits. The pieces shall be conical in shape and shall have granular or crystalline surfaces. Friable, flaky and laminated pieces, mica and shale, if present, shall be only in such quantities that will not, in the opinion of the Engineer, affect adversely the strength and/or durability of concrete. The maximum size of coarse aggregate shall be 40 mm for M15 to M30 concrete and 20 mm for M35 and M40 concrete, or as directed by the Engineer or specified otherwise. The maximum size of coarse aggregate shall be the maximum size specified above, but in no case greater than 1/4 of the minimum thickness of the member, provided that the concrete can be placed without difficulty so as to surround all reinforcement thoroughly and fill the corners of the form.

Plums above 160 mm and up to any reasonable size can be used in plain mass concrete work of large dimensions up to a maximum limit of 20% by volume of concrete when specifically approved by the Engineer. For heavily reinforced concrete members, the nominal maximum size of the aggregate shall be 5 mm less than the minimum clear distance between the reinforcing main bars or 5 mm less than the minimum cover to the reinforcement whichever is smaller. The amount of fine particles occurring in the free state or as loose adherent shall not exceed 1% when determined by laboratory sedimentation tests as per IS 2386. After 24 hours' immersion in water, a previously dried sample shall not have gained more than 10% of its oven dry weight in air, as determined by IS 2386.

2.Fine Aggregate:

Fine aggregate except as noted above, and for other than lightweight concrete shall consist of natural or crushed sand conforming to IS 383. The Sand shall be clean, sharp, hard, strong and durable and shall be free from dust, vegetable substances, adherent coating, clay, alkali, organic matter, mica, salt or other deleterious substances, which can be injurious to the setting qualities/strength/durability of concrete.

SECTION 11

FRAUD

AND

CORRUPT

PRACTICES

FRAUD AND CORRUPT PRACTICES

- The Applicants and their respective officers, employees, agents and advisers shall observe the highest standard of ethics during the Bidding Process. Notwithstanding anything to the contrary contained herein, the Authority may reject an Application without being liable in any manner whatsoever to the Applicant if it determines that the Applicant has, directly or indirectly or through an agent, engaged in corrupt practice, fraudulent practice, coercive practice, undesirable practice or restrictive practice in the Bidding Process.
- Without prejudice to the rights of the Authority under relevant Clause hereinabove, if an Applicant is found by the Authority to have directly or indirectly or through an agent, engaged or indulged in any corrupt practice, fraudulent practice, coercive practice, undesirable practice or restrictive practice during the Bidding Process, such Applicant shall not be eligible to participate in any tender or RFQ issued by the Authority during a period of 2 (two) years from the date such Applicant is found by the Authority to have directly or indirectly or through an agent, engaged or indulged in any corrupt practice, fraudulent practice, coercive practice, undesirable practice or restrictive practice, as the case may be.
- For the purposes of this Clause , the following terms shall have the meaning hereinafter respectively assigned to them:
 - A. **“corrupt practice”** means
the offering, giving, receiving, or soliciting, directly or indirectly, of anything of value to influence the actions of any person connected with the Bidding Process (for avoidance of doubt, offering of employment to, or employing, or engaging in any manner whatsoever, directly or indirectly, any official of the Authority who is or has been associated in any manner, directly or indirectly, with the Bidding Process or the LOA or has dealt with matters concerning the Concession Agreement or arising there from, before or after the execution thereof, at any time prior to the expiry of one year from the date such official resigns or retires from or otherwise ceases to be in the service of the Authority, shall be deemed to constitute influencing the actions of a person connected with the Bidding Process); or
save and except as permitted under the relevant sub clause, engaging in any manner whatsoever, whether during the Bidding Process or after the issue of the LOA or after the execution of the Concession Agreement, as the case may be, any person in respect of any matter relating to the Project or the LOA or the Concession Agreement, who at any time has been or is a legal, financial or technical adviser of the Authority in relation to any matter concerning the Project;

- B. **“fraudulent practice”** means a misrepresentation or omission of facts or suppression of facts or disclosure of incomplete facts, in order to influence the Bidding Process ;
- C. **“coercive practice”** means impairing or harming or threatening to impair or harm, directly or indirectly, any person or property to influence any persons participation or action in the Bidding Process;
- D. **“undesirable practice”** means (i) establishing contact with any person connected with or employed or engaged by the Authority with the objective of canvassing, lobbying or in any manner influencing or attempting to influence the Bidding Process; or (ii) having a Conflict of Interest; and
- E. **“Restrictive practice”** means forming a cartel or arriving at any understanding or arrangement among Applicants with the objective of restricting or manipulating a full and fair competition in the Bidding Process.
- F. If the Employer/Financier determines that the Contractor has engaged in corrupt, fraudulent, collusive, coercive or obstructive practices, in competing for or in executing the Contract, then the Employer may, after giving 14 days’ notice to the Contractor, terminate the Contractor's employment under the Contract and expel him from the Site, and the provisions of relevant Clause shall apply as if such expulsion had been made.
- G. Should any employee of the Contractor be determined to have engaged in corrupt, fraudulent, collusive, coercive, or obstructive practice during the execution of the Works, then that employee shall be removed in accordance with relevant Clause.

For the purposes of this Sub-Clause:

- i. “corrupt practice” is the offering, giving, receiving to soliciting, directly or indirectly, of anything of value to influence improperly the actions of another party;
- ii. “another party” refers to a public official acting in relation to the procurement process or contract execution. In this context, “public official” includes Financer staff and employees of other organizations taking or reviewing procurement decisions.
- iii. “fraudulent practice” is any act or omission, including a misrepresentation, that knowingly or recklessly misleads, or attempts to mislead, a party to obtain a financial or other benefit or to avoid an obligation;

- iv. “collusive practice” is an arrangement between two or more parties designed to achieve an improper purpose, including to influence improperly the actions of another party;
- v. “coercive practice” is impairing or harming, or threatening to impair or harm, directly or indirectly, any party or the property of the party to influence improperly the actions of a party;
- vi. “obstructive practice” is deliberately destroying, falsifying, altering or concealing of evidence material to the investigation or making false statements to investigators in order to materially impede the Financier investigation into allegations of a corrupt, fraudulent, coercive or collusive practice; and/or threatening, harassing or intimidating any party to prevent it from disclosing its knowledge of matters relevant to the investigation or from pursuing the investigation; or
- vii. acts intended to materially impede the exercise of the Financier’s inspection and audit rights provided .
- viii. “party” refers to a public official; the terms “benefit” and “obligation” relate to the procurement process or contract execution; and the “act or omission” is intended to influence the procurement process or contract execution.
- ix. ”parties” refers to participants in the procurement process (including public officials) attempting to establish bid prices at artificial, noncompetitive levels.
- x. a “party” refers to a participant in the procurement process or contract execution.

SECTION 12

PRE BID MEETING

PREBID MEETING

Pre-bid meeting of the interested parties shall be convened at the designated date, time and place. A maximum of three representatives of each Applicant shall be allowed to participate on production of authority letter from the Applicant.

During the course of Pre-bid meeting, the Applicants will be free to seek clarifications and make suggestions for consideration of the Authority. The Authority shall Endeavour to provide clarifications and such further information as it may, in its sole discretion, consider appropriate for facilitating a fair, transparent and competitive Bidding Process.

6.9.2 Interpretation of e-Tender Document:

- a) Tenderer(s) shall examine the tender document and acquaint themselves to all conditions and matters affecting the cost of the works. If any tenderer(s) finds discrepancies or omissions in the Document or if in doubt about their meaning, he should address a query during pre-bid meeting.
- b) Any resulting interpretation of the tender document will be issued to tenderer(s) as an addendum. Verbal clarification obtained from any source shall not be binding on the Corporation.
- c) No tenderer(s) shall amend the text of any document except as may be necessary to comply with any addendum.

6.9.3 Clarification of e-Tendering Documents

6.9.4 Pre-bid meeting (If proposed as per e-Tender notice)

- a) The tenderer or his authorized representative is allowed to attend a pre-bid meeting as per the date, time and venue mentioned in the tender notice/header data.
- b) The purpose of the pre-bid meeting will be to clarify issues and to answer questions on any matter that may be raised prior to the pre-bid meeting. i.e. on before **02/11/2022** by **3:00pm**.
- c) Any tenderer requiring any clarification of the tender document and/or the works may submit his questions in e-mail on ewwccivilmaintes.he@mcgm.gov.in to reach Executive Engineer (Maintenance) office.

SECTION –13

LIST OF APPROVED

BANKS

LIST OF APPROVED BANKS

- 1) The following Banks with their branches in Greater Mumbai and in suburbs and extended suburbs up to Virar and Kalyan have been approved only for the purpose of accepting Banker's guarantee from 1997-98 onwards until further instructions.
- 2) The Bankers Guarantee issued by branches of approved Banks beyond Kalyan and Virar can be accepted only if the said Banker's Guarantee is countersigned by the Manager of a branch of the same Bank, within the Mumbai Limit categorically endorsing thereon that said bankers Guarantee is binding on the endorsing Branch of the bank within Mumbai limits and is liable to be on forced against the said branch of the Bank in case of default by the contractor/supplier furnishing the bankers Guarantee.

List of approved Banks:-

A	SBI AND ASSOCIATES
1	State Bank of India
2	State Bank of Bikaner & Jaipur
3	State Bank of Hyderabad
4	State Bank of Indore
5	State Bank of Mysore
6	State Bank of Patiala
7	State Bank of Saurashtra
8	State Bank of Travancore
B	NATIONALIZED BANKS
9	Allahabad Bank merged with Indian Bank
10	Andhra Bank merged with Union Bank of India
11	Bank of Baroda
12	Bank Of India.
13	Bank Of Maharashtra.
14	Canara Bank
15	Central Bank of India

16	Corporation Bank merged with Union Bank of India
17	Dena Bank merged with BOB
18	Indian Bank
19	Oriental Bank of Commerce merged with Punjab National Bank
20	Punjab National Bank
21	Punjab and Sind Bank
22	Syndicate Bank merged with Canara Bank
23	UCO Bank
24	Union Bank of India
25	United Bank of India merged with Punjab National Bank
26	Vijaya Bank merged with BOB
C	OTHER PUBLIC SECTOR BANKS
27	Industrial Development Bank of India Ltd.
D	PRIVATE SECTOR BANKS
28	Bank of Rajasthan Ltd.
29	Catholic Syrian Bank Ltd.
30	City Union Bank Ltd.
31	Development Credit Bank.
32	Dhanalakshmi Bank Ltd.
33	Federal Bank Ltd.
34	HDFC Bank Ltd.
35	ICICI Bank Ltd.
36	IndusInd Bank Ltd.
37	ING Vysya Bank Ltd.
38	Jammu and Kashmir Bank Ltd.
39	Karnataka Bank Ltd.

40	Karur Vysya Bank Ltd.
41	Kotak Mahindra Bank Ltd.
42	Lakshmi Vilas Bank Ltd.
43	Nainital Bank Ltd.
44	Ratnakar Bank Ltd.
45	SBI Commercial International Bank Ltd.
46	South Indian Bank Ltd.
47	United Western Bank Ltd.
48	Axis Bank Ltd.
49	Yes Bank Ltd.
E	FOREIGN BANKS
50	ABN Amro Bank N.V.
51	Abu Dhabi Commercial Bank Ltd.
52	American Express Banking Corporation
53	Antwerp Diamond Bank N.V.
54	Arab Bangladesh Bank
55	Bank International Indonesia
56	Bank of America
57	Bank of Bahrain and Kuwait B.S.C.
58	Bank of Ceylon
59	Bank of Nova Scotia
60	Bank of Tokyo – Mitsubishi Ltd.
61	Barclays Bank Plc.
62	BNP Paribas
63	China Trust Commercial Bank
64	Shinhan Bank

65	Citi Bank N.A.
66	Calyon Bank
67	Deutsche Bank
68	DBS Bank Ltd.
69	The Hongkong and Shanghai Banking Corporation Ltd.
70	J.P. Morgan Chase Bank N.A.
71	Krung Thai Bank Public Company Ltd.
72	Mashreq Bank p.s.c.
73	Mizuho Corporate Bank Ltd.
74	Oman International Bank S.A.O.G.
75	SocieteGenerale
76	Sonali Bank
77	Standard Chartered Bank
78	State Bank of Mauritius Ltd
F	Urban Co-operative Banks
79	A P Mahesh Co-operative Urban Bank Ltd., Hyderabad
80	Abhyudaya Co-operative Bank Ltd., Mumbai
81	Ahmedabad Mercantile Co-operative Bank Ltd., Ahmedabad
82	Akola Janata Commercial Co-operative Bank Ltd., Akola
83	Amanath Co-operative Bank Ltd., Bangalore
84	Bassein Catholic Co-operative Bank Limited, Vasai
85	Bharat Co-operative Bank (Mumbai) Ltd., Mumbai
86	Bharati Sahakari Bank Ltd., Pune
87	Bombay Mercantile Co-operative Bank Limited, Mumbai
88	Charminar Co-operative Urban Bank Ltd., Hyderabad
89	Citizen Credit Co-operative Bank Ltd., Mumbai

90	Dombivli Nagari Sahakari Bank Ltd., Dombivli
91	Greater Bombay Co-operative Bank Limited, Mumbai
92	Indian Mercantile Co-operative Bank Ltd., Lucknow
93	Jalgaon Janata Sahakari Bank Ltd., Jalgaon
94	JanakalyanSahakari Bank Ltd., Mumbai
95	Janalaxmi Cooperative Bank Ltd., Nashik
96	Janata Sahakari Bank Ltd., Pune
978	KallappannaAwadeIchalkaranji Janata Sahakari Bank Ltd., Ichalkaranji
98	Kalupur Commercial Co-operative Bank Ltd., Ahmedabad.
99	Kalyan Janata Sahakari Bank Ltd., Kalyan
100	Kapol Cooperative Bank Ltd., Mumbai
101	Karad Urban Co-operative Bank Ltd., Karad
102	Madhavapura Mercantile Co-operative Bank Ltd., Ahmedabad
103	Mahanagar Co-operative Bank Ltd., Mumbai
104	Mapusa Urban Co-operative Bank of Goa Ltd., Mapusa
105	Mehsana Urban Co-operative Bank Ltd., Mehsana
106	N K G S B Co-operative Bank Ltd., Mumbai
107	Nagar Urban Co-operative Bank Ltd., Ahmednagar
108	Nagpur Nagrik Sahakari Bank Ltd., Nagpur
109	New India Co-operative Bank Ltd., Mumbai
110	Nutan Nagrik Sahakari Bank Ltd., Ahmedabad
112	Parsik Janata Sahakari Bank Ltd., Thane
113	Pravara Sahakari Bank Ltd., Loni
114	Punjab & Maharashtra Co-operative Bank Ltd., Mumbai
115	Rajkot Nagrik Sahakari Bank Ltd., Rajkot
116	Rupee Co-operative Bank Ltd., Pune

117	Sangli Urban Co-operative Bank Ltd., Sangli
118	Saraswat Co-operative Bank Ltd., Mumbai
119	Sardar BhiladwalaPardi People's Co-operative Bank Ltd., Killa Pardi
120	Shikshak Sahakari Bank Ltd., Nagpur
121	Solapur Janata Sahakari Bank Ltd., Solapur
122	Surat People's Co-operative Bank Ltd., Surat
123	Thane Bharat Sahakari Bank Ltd., Thane
124	Thane Janata Sahakari Bank Ltd., Thane
125	The Akola Urban Co-operative Bank Ltd., Akola
126	The Cosmos Co-operative Bank Ltd., Pune
127	The Goa Urban Co-operative Bank Ltd., Panaji
128	The Khamgaon Urban Co-operative Bank Ltd., Khamgaon
129	The Nasik Merchant's Co-operative Bank Ltd., Nasik
130	The ShamraoVithal Co-operative Bank Ltd., Mumbai
131	The Zoroastrian Co-operative Bank Ltd., Mumbai
132	Vasavi Co-operative Urban Bank Limited, Hyderabad

- **This list is for information and may change**

SECTION –14

APPENDIX

FORM OF TENDER

To,
The Municipal Commissioner for Greater Mumbai
Sir,

I/ We have read and examined the following documents relating to the construction of

- i. Notice inviting tender.
- ii. Directions to tenderers (General and special)
- iii. General condition of contract for Civil Works of the Municipal Corporation of Greater Mumbai as amended up to date.
- iv. Relevant drawings
- v. Specifications.
- vi. Special directions
- vii. Annexure A and B.
- viii. Bill of Quantities and Rates.

1A. I/We

(full name in capital letters, starting with surname), the Proprietor/ Managing Partner/
Managing Director/ Holder of the Business, for the establishment / firm / registered com-
pany, named herein below, do hereby offer to

.....
.....
.....
.....
.....
.....
.....

Referred to in the specifications and schedule to the accompanying form of contract of the rates entered in the schedule of rates sent herewith and signed by me/ us” (strike out the portions which are not applicable).

1B. I/We do hereby state and declare that I/We, whose names are given herein below in details with the addresses, have not filled in this tender under any other name or under the name of any other establishment /firm or otherwise, nor are we in any way related or concerned with the establishment /firm or any other person, who have filled in the tender for the aforesaid work.”

2. I/We hereby tender for the execution of the works referred to in the aforesaid documents, upon the terms and conditions, contained or referred to therein and in accordance with the specifications designs, drawings and other relevant details in all respects.

* At the rates entered in the aforesaid Bill of Quantities and Rates.

3. According to your requirements for payment of Earnest Money amounting to Rs. _____/(Rs.

_____)

I/We have deposited the amount through online payment gateways with the C.E. of the Corporation not to bear interest

4. I/We hereby request you not to enter into a contract with any other person/s for the execution of the works until notice of non/acceptance of this tender has first been communicated to me/us, and in consideration of yours agreeing to refrain from so doing I/we agree not to withdraw the offer constituted by this tender before the date of communication to me/us of such notice of non/acceptance, which date shall be not later than ten days from the date of the decision of the Standing Committee or Education Committee of the Corporation, as maybe required under the Mumbai Municipal Corporation Act, not to accept this tender.(Subject to condition 5 below).
5. I/We also agree to keep this tender open for acceptance for a period of 180 days from the date fixed for opening the same and not to make any modifications in its terms and conditions which are not acceptable to the Corporation.
6. I/We agree that the Corporation shall, without prejudice to any other right or remedy, be at liberty to forfeit the said earnest money absolutely, if.
 - a. I/We fail to keep the tender open as aforesaid.
 - b. I/We fail to execute the formal contract or make the contract deposit when called upon to do so.
 - c. I/we do not commence the work on or before the date specified by the Engineer in his work order.
7. I/We hereby further agree to pay all the charges of whatsoever nature in connection with the preparation, stamping and execution of the said contract.
8. I/We further agree that, I/we shall register ourselves as ‘Employer’ with the Bombay Iron and Steel Labour Board’ and fulfill all the obligatory provisions of Maharashtra Mathadi, Hamal and other Manual workers (Regulation of Employment and Welfare) Act 1969 and the Bombay Iron and Steel unprotected workers Scheme 1970.
9. “I/We..... have failed in the accompanying tender with full knowledge of liabilities and, therefore, we will not raise any objection or dispute in any manner relating to any action, including forfeiture of deposit and blacklisting, for giving any information, which is found to be incorrect and against the instructions and directions given in this tender.
10. “I/We further agree and undertake that in the event it is revealed subsequently after the allotment of work/contract to me/us, that any information given by me/us in this tender is false or incorrect, I/We shall compensate the Municipal Corporation of Greater Mumbai for any such losses or inconvenience caused to the Corporation in any manner and will not resist any claim for such compensation on any ground whatsoever. I/we agree and undertake that I/we shall not claim in such case any amount by way of damages or compensation for cancellation of the contract given to me/us or any work assigned to me/us or is withdrawn by the Corporation,”

Address

Yours

faithfully,

.....

.....

Digital Signature of the Tenderer or the Firm

1.....

2.....

3.....

4.....

5.....

Full Name and private residential address of all the partners constituting the Firm

A/c No.

....

.....

....

1.

Name of Bank

2.

.....

.....

3.

Name of Branch

4.

.....

.....

5.

Vender

No.

.....

AGREEMENT FORM

Tender / Quotation

dated 20...

Standing Committee/Education Committee Resolution No.
CONTRACT FOR THE WORKS

.....
.....
.....

This agreement made this day of
Two thousand
Between

.....
.....
.....

inhabitants of Mumbai, carrying on business at.....

.....
in Bombay under the style and name of Messrs
.....
..... (Hereinafter called “the contractor of the one part and Shri
.....

the DMC(SE) (hereinafter called “the commissioner” in which expression are included unless the inclusion is inconsistent with the context, or meaning thereof, his successor or successors for the time being holding the office of DMC(SE) of the second part and the Municipal Corporation of Greater Mumbai (hereinafter called “the Corporation”) of the third part, WHEREAS the contractor has tendered for the construction, completion and maintenance of the works described above and his tender has been accepted by the Commissioner (with the approval of the Standing Committee/Education Committee of the Corporation NOW THIS

THIS AGREEMENT WITNESSETH as follows:-

- 1) In this agreement words and expressions shall have the same meanings as are respectively assigned to them in the General Conditions of Contract for works hereinafter referred to:-
- 2) The following documents shall be deemed to form and be read and constructed as a part of this agreement viz.
 - a) The letter of Acceptance
 - b) The Bid:
 - c) Addendum to Bid; if any
 - d) Tender Document
 - e) The Bill of Quantities:
 - f) The Specification:
 - g) Detailed Engineering Drawings
 - h) Standard General Conditions of Contracts (GCC)

- i) All correspondence documents between bidder and MCGM
- 3) In consideration of the payments to be made by the Commissioner to the contractor as hereinafter mentioned the contractor hereby covenants with the Commissioner to construct, complete and maintain the works in conformity in all respects with the provision of the contract.
- 4) The Commissioner hereby covenants to pay to the Contractor in consideration of the construction, completion and maintenance of the works the contract sum, at times and in the manner prescribed by the contract.

IN WITNESS WHERE OF the parties hereto have caused their respective common seals to be herein to affixed (or have hereunto set their respective hands and seals) the day and year above written.

Signed, Sealed and delivered by the contractors

In the presence of

Trading under the name and style of

Full Name
 Address

Contractors

Signed by the DMC(SE) in the presence of

Ex. City/ WS/ ES

 DMC (SE)

The Common seal of the Municipal Corporation of Greater Mumbai was hereunto affixed on the 20 in the presence of two members of the Standing Committee.

1.

1.

2.

2.

And in the presence of the Municipal Secretary

Municipal Secretary

ANNEXURE " A "

Name of work: Reconstruction of compound wall along Trunk Main on R. N. Gandhi Marg in N ward.
(Bid No:- 7200038419)

.Earnest Money

- | | |
|--|---|
| a) Name of Ward | : 'N' ward |
| b) Estimated cost of Tender | : Rs. 3,11,02,375.00 |
| c) Earnest Money
(1% of the Estimated Cost of the tender) | : Rs. 3,11,300.00 |
| 1) Definition | : The Engineer for this work is
Hydraulic Engineer (H.E). |
| 2) Security Deposit Comprise of | : 17% of the Contract Sum |
| a) Contract Deposit | : 2% of the Contract Sum |
| b) Retention Money | : 15% of the contract payment. |
| 3) Time Period | : Period of completion.
09 (nine) Months Excluding Monsoon) |
| Contract as a whole | : _____ |
| 4) Supervision Charges | : Ten percent (10%) |
| 5) Advances (Recovery of advances) | : as per G.C.C |
| 6) Salvage Value of the work | : N/A |

Signature of Issuing Officer

Signature of Contractor

Date: _____

Annexure- B

PRE-CONTRACT INTEGRITY PACT

The Bidder commits himself to take all measures necessary to prevent corrupt practices, unfair means and illegal activities during any stage of his bid or during any pre-contract or post-contract stage in order to secure the contract or in furtherance to secure it and in particular commits himself to the following:-

1. The Bidder will not offer, directly or through intermediaries, any bribe, gift, consideration, reward, favour, any material or immaterial benefit or other advantage, commission, fees, brokerage or inducement to any official of the MCGM, connected directly or indirectly with the bidding process, or to any person, organization or third party related to the contract in exchange for any advantage in the bidding, evaluation, contracting and implementation of the Contract.
2. The Bidder further undertakes that he has not given, offered or promised to give, directly or indirectly any bribe, gift, consideration, reward, favour, any material or immaterial benefit or other advantage, commission, fees, brokerage or inducement to any official of the MCGM or otherwise in procuring the Contract or forbearing to do or having done any act in relation to the obtaining or execution of the Contract or any other Contract with the Government for showing or forbearing to show favour or disfavour to any person in relation to the Contract or any other Contract with the Government.
3. The Bidder will not collude with other parties interested in the contract to impair the transparency, fairness and progress of the bidding process, bid evaluation, contracting and implementation of the contract.
4. The Bidder will not accept any advantage in exchange for any corrupt practice, unfair means and illegal activities.
5. The Bidder, either while presenting the bid or during pre-contract negotiations or before signing the contract, shall disclose any payments he has made, is committed to or intends to make to officials of the MCGM or their family members, agents, brokers or any other intermediaries in connection with the contract and the details of services agreed upon for such payments.

6. The Bidder shall not use improperly, for purposes of competition or personal gain, or pass on to others, any information provided by the MCGM as part of the business relationship, regarding plans, technical proposals and business details, including information contained in any electronic data carrier. The Bidder also undertakes to exercise due and adequate care lest any such information is divulged.
7. The Bidder commits to refrain from giving any complaint directly or through any other manner without supporting it with full and verifiable facts.
8. The Bidder shall not instigate or cause to instigate any third person to commit any of the actions mentioned above.
9. The Bidder and their respective officers, employees, agents and advisers shall observe the highest standard of ethics during the Bidding Process. Notwithstanding anything to the contrary contained herein, the Authority may reject an Application without being liable in any manner whatsoever to the Applicant if it determines that the Applicant has, directly or indirectly or through an agent, engaged in corrupt practice, fraudulent practice, coercive practice, undesirable practice or restrictive practice in the Bidding Process

For the purposes of this Clause 9, the following terms shall have the meaning herein after respectively assigned to them:

1. “fraudulent practice” means a misrepresentation or omission of facts or suppression of facts or disclosure of incomplete facts, in order to influence the Bidding Process ;
2. “coercive practice” means impairing or harming or threatening to impair or harm, directly or indirectly, any person or property to influence any persons participation or action in the Bidding Process;
3. “undesirable practice” means (i) establishing contact with any person connected with or employed or engaged by the Authority with the objective of canvassing, lobbying or in any manner influencing or attempting to influence the Bidding Process; or (ii) having a Conflict of Interest; and
4. “restrictive practice” means forming a cartel or arriving at any understanding or arrangement among Applicants with the objective of restricting or manipulating a full and fair competition in the Bidding Process.

Signature of Tenderer/Bidder

Annexure- C

(On Rs. 500/- Stamp Paper)

DECLARATION CUM INDEMNITY BOND

I, _____ of _____, do hereby declared and undertake
as under.

1. I declare that I have submitted certificates as required to Executive engineer
(Monitoring) at the time of registration of my firm/company _____ and there is no change in
the contents of the certificates that are submitted at the time of registration.

2. I declare that I _____ in capacity as Manager/Director/Partners/Proprietors of
_____ has not been charged with any prohibitory and /or penal action such as banning(for
specific time or permanent)/de-registration or any other action under the law by any Government
and/or Semi Government and/or Government undertaking.

3. I declare that I have perused and examined the tender document including addendum, condition
of contract, specifications, drawings, bill of quantity etc. forming part of tender and accordingly, I
submit my offer to execute the work as per tender documents at the rates quoted by me in capacity
as _____ of _____.

4.I further declare that if I am allotted the work and I failed to carry out the allotted work in ac-
cordance with the terms and conditions and within the time prescribed and specified, MCGM is
entitled to carry out the work allotted to me by any other means at my risk and cost, at any stage
of the contract.

5. I also declare that I will not claim any charge/damages/compensation for non availability of site
for the contract work at any time.

6. I declare that I will positively make the arrangements of the required equipment on the day of
commencement or with respect to the progress of the work in phases, as per the instructions of
site in charge

Signature of Tenderer/Bidder

BANKERS GURANTEE IN LIEU OF CONTRACT DEPOSIT

THIS INDENTURE made this _____ day of _____ BETWEEN

THE _____ BANK incorporated under the English/Indian Companies Acts and carrying on business in Mumbai (hereinafter referred to as 'the bank' which expression shall be deemed to include its successors and assigns)of the first part
_____ inhabitants carrying on business at _____ in Mumbai under the style and name of Messer's _____ (hereinafter referred to as 'the consultant') of the second part Shri. _____

THE MUNICIPAL COMMISSIONER FOR GREATER MUMBAI (hereinafter referred to as 'the commissioner' which expression shall be deemed, also to include his successor or successors for the time being in the said office of Municipal Commissioner) of the third part and THE MUNICIPAL CORPORATION OF GREATER MUMBAI (hereinafter referred to as 'the Corporation') of the fourth part WHEREAS the consultants have submitted to the Commissioner tender for the execution of the work of " _____ and the terms of such tender /contract require that the consultants shall deposit with the Commissioner as/contract deposit/ earnest money and /or the security a sum of Rs. _____ (Rupees _____) AND WHEREAS if and when any such tender is accepted by the Commissioner, the contract to be entered into in furtherance thereof by the consultants will provide that such deposit shall remain with and be appropriated by the Commissioner towards the Security -deposit to be taken under the contract and be redeemable by the consultants, if they shall duly and faithfully carry out the terms and provisions of such contract and shall duly satisfy all claims properly chargeable against them there under AND WHEREAS the consultants are constituents of the Bank and in order to facilitate the keeping of the accounts of the consultants, the Bank with the consent and concurrence of the consultants has requested the Commissioner to accept the undertaking of the Bank hereinafter contained, in place of the contractors depositing with the Commissioner the said sum as earnest money and /or security as aforesaid AND WHEREAS accordingly the Commissioner has agreed to accept such undertaking NOW THIS AGREEMENT WITNESSES that in consideration of the premises, the Bank at the request of the consultants (hereby testified) UNDERTAKES WITH the commissioner to pay to the commissioner upon demand in writing , whenever required by him , from time to time , so to do ,a sum not exceeding in the whole Rs. _____ (Rupees _____) under the terms of the said tender and /or the contract .The B.G. Is valid upto _____”Notwithstanding

anything what has been stated above, our liability under the above guarantee is restricted to Rs. _____ only and guarantee shall remain in force upto _____ unless the demand or claim under this guarantee is made on us in writing on or before _____ all your right under the above guarantee shall be forfeited and we shall be released from all liabilities under the guarantee thereafter”

IN WITNESS WHEREOF

WITNESS(1) _____

Name and _____

address _____

WITNESS(2) _____

Name and _____ the duly constituted Attorney Manager

address _____

the Bank and the said Messer’s _____

_____ (Name of the Bank)

WITNESS(1) _____

Name and _____

address _____

WITNESS(2) _____

Name and _____

For Messer’s _____

address _____

have here into set their respective hands the day and year first above written.

The amount shall be inserted by the Guarantor, representing the Contract Deposit in Indian Rupees.

**➤ PROFORMA FOR THE UNDERTAKING TO BE SUBMITTED BY THE TENDERER
(ON THEIR LETTERHEAD)**

Date: _____

To,
The Municipal Commissioner,
Municipal Corporation of Greater Mumbai,
Mumbai.

Sub: _____

Sir,

We, the undersigned hereby undertake that

1. All Asphalt Works required to be done under the captioned contract work shall be got executed with the specified asphalt mixes manufactured in M.C.G.M. approved Asphalt Plants only.
2. All the Paver blocks required for the Paver block works to be carried out under the captioned contract work shall be procured from the specified manufacturers approved with M.C.G.M.
3. The R.M.C. works required to be done under the captioned contract work shall be got executed with the specified R.M.C. mixes supplied by M.C.G.M. approved R.M.C. plants only.
4. All the pipes/ specials required for the works will be procured from the manufacturer approved with M.C.G.M only.
5. All the M.S pipes/ specials will be fabricated from B.I.S. approved Company/ I.S.O 9000 Certified Company, confirmed to I.S 3589, I.S 2062.
6. All the Air valves, Sluice valves & the Butterfly Valves will be procured from the Company approved with M.C.G.M.
7. All the observations & instructions made by the quality assurance agency appointed if any for the tender work are binding on us and same will be complied immediately.

Yours Faithfully,

Signature

Rubber Stamp.

Information regarding status of tender (s)
(To be submitted on Tenderers letter head)

- 1 a) Whether it is proprietary concern?

- b) If so, name of the owner

If it is partnership concern, please furnish name and address of each partner and copy of registration certificate.

2. In case of Company, please furnish documentary proof to show that the Company registered.

Signature of authorized person of

Concern/ Company.

Annexure- D

Each tenderer shall upload scanned copy of an undertaking on stamp paper of Rs 500/- as per Performa given below, in packet “B”. The undertaking shall be submitted in physical format within seven days from the date of issue of work order, if the tender is awarded to the bidder.

Undertaking for Best Price

(On Rs. 500/- stamp paper)

Date: _____

To,
The Municipal Commissioner,
Municipal Corporation of Greater Mumbai,
Mumbai.

Sir,

Bid No: _____

I/We

(full name in capital letters , starting with surname) , the Proprietor / Managing Partner / Managing Director / Holder of the Business/Manufacturer/Authorized Dealer, for the establishment /firm/registered company, named herein below, do hereby state and declare that I/We..... whose names are given herein below in details with the addresses have not filled in this tender under any other name of any other establishment/ Firm or otherwise, nor are we in any way related or concerned with any establishment/ firm or any other person, who have filled in the tender for the above said work.

“I/We

(full name in capital letters , starting with surname) , the Proprietor / Managing Partner / Managing Director / Holder of the Business/Manufacturer/Authorized Dealer, for the establishment /firm/registered company, named herein below, do hereby undertake that we have offered the best prices for the subject Supply work as per the present market rates. **Further we do hereby undertake and commit that we have not offered/supplied the subject product/similar product/system or sub systems in past one year in Maharashtra state for Quality variation Upto -50% or +10% at a price lower than that offered in the present bid to any other outside agencies including Govt./semi Govt. agencies and within the MCGM also.** Further, we have filled in the accompanying tender with full knowledge of the above liabilities and therefore we will not raise any objection or dispute in any manner relating to any action, including forfeiture of deposit and blacklisting, for giving any information which is found to be incorrect and against the instructions and directions given in this behalf in this tender.

I/We further agree and undertake that in the event it is revealed subsequently after the allotment of work / contract to me / us, that any information given by me / us in this tender is false or incorrect, I / We shall compensate the Municipal Corporation of Greater Mumbai for any such losses or inconvenience caused to the Corporation in any manner and will not resist any claim for such compensation on any ground whatsoever. I / We agree and undertake that I / We shall not claim in such case any amount, by way of damages or compensation for cancellation of the

contract given to me / us or any work assigned to me / us or as withdrawn by the Corporation.”

However, in case of price difference, if it is a result of differential tax structures, different Dollar value of Rupee. Differential logistic of transport etc. Considering this aspect, before invoking the penalty, blacklisting, I/We will be given a reasonable opportunity of being heard our case as to why such price variation has been arisen.

In case if the explanation submitted by me/ us is unsatisfactory then action including forfeiture of deposit & blacklisting may be taken against me/us.

Tenderer's Full Name, Signature and address with rubber stamp.

Annexure- E
Rate Analysis

Item Description

Sr.No.	Description of rate analysis parameters	Unit	Quantity	Rate	Amount
1	Basic Material (Rate should be inclusive of all taxes)				
2	Machinery Hire Charges				
3	Labour Type		(labour components)		
4	Total of all components				
5	Overhead & Profit 15% on 4				
6	Total Rate (4+5)				
7	Per unit rate				

Sign & Seal of the Tenderer

PROFORMAS:

PROFORMA- I

The list of similar works as stated in Para 'A' of Post qualification during last seven years–

PROFORMA- I						
Sr.No.	Name of the Project	Name of the employer	Stipulated date of completion	Actual date of completion	Actual Cost of work done (in Lakhs)	Certifying Authority
1	2	3	4	5	6	7

NOTE:

- j. Scanned Attested copies of completion/performance certificates from the Engineer-in-Charge for each work should be annexed in the support of information furnished in the above proforma.
- k. Works shall be grouped financial year-wise.

PROFORMA- II

Yearly turnover of Civil Engineering Construction Works during the last five years.

PROFORMA- II					
Sr.No.	Financial year	Annual Turnover of Civil Engineering Works	Updated value to current year	Average of last 5years	Page No.
1					
2					
3					
4					
5					
Total					

NOTE: The above figures shall tally with the audited balance sheets uploaded by the tenderers duly certified by Chartered Accountant.

PROFORMA- III

At least similar work, as stated in para 'A' of Post qualification,

PROFORMA- III							
Name of the Project	Name of the Employer	Cost of the Project	Date of issue of work Order	Stipulated Date of Completion	Actual Date of Completion	Actual cost of work done	Remarks explaining reasons for delay, if any
1	2	3	4	5	6	7	8

Note: Scanned Attested copies of completion/performance certificates from the Engineer-in-charge for each work should be annexed in support of information furnished in the above proforma.

PROFORMA- IV

PERSONNEL:

PROFORMA- IV					
Sr. No.	Post	Name (Prime Candidate/ Alternate)	Qualification	Work Experience	
				No. of Years	Name of Projects
1	Project Manager				
2	Quality Control Engineer				
3	Site Engineer				
4	Site Supervisor				

NOTE: Scanned Attested copies of qualification certificates and details of work experience shall be submitted /uploaded.

PROFORMA- V

MACHINERY:

for special work

PROFORMA- V/A			
Sr.No.	Equipment	Number	Owned/Leased/Assured access
1	2	3	4

PROFORMA- V/B			
Sr.No.	Equipment	Number	Owned
1	2	3	4

Note: The tenderer(s) shall furnish/upload the requisite Scanned Attested documents of ownership/leased of machineries. The undertaking from the suppliers will not be accepted.

a) For Regular, Routine, Maintenance And Original & New Construction Works

The tenderer(s) to qualify this bid shall either own equipments, in full working order, as listed below, or must demonstrate that based on known commitments, they will be available for timely use in the proposed contract as specified in Equipment Capability

PROFORMA V/C			
<i>Sr.No</i>	<i>Equipments owned / access to</i>	<i>Requirements (No)</i>	<i>RTO Vehicle nos / Invoice no.</i>
<i>1</i>	<i>2</i>	<i>3</i>	<i>4</i>

Note: The tenderer(s) shall furnish/upload the requisite Scanned Attested documents of ownership/leased of machineries. The undertaking from the suppliers will not be accepted.

PROFORMA - VI

Details of Existing Commitments and ongoing works –

PROFORMA - VI / A							
Description of work	Place	Contract No. & Date	Name & Addresses of employer	Value of Contract in Rs.	Scheduled date of completion	Value of work remaining to be completed	Anticipated Date of completion
1	2	3	4	5	6	7	8

Note: Scanned Attested copies of completion/performance certificates from the Engineer-in-Charge for each work should be annexed in the support of information furnished in the above proforma.

Details of works for which bids are already uploaded –

PROFORMA - VI / B						
Description of work	Place	Name & Addresses of employee	Value of Contract in Rs.	Time Period	Date on which decision is expected	Remarks
1	2	3	4	5	6	7

Note: Scanned Attested copies of certificates from the Engineer-in-charge for each work shall be annexed.

PROFORMA VII

~~Maximum Quantity of total Pavement Quality Concrete (M35 or richer mix) on volumetric basis in Cu.m, completed in one single contract during the last seven(7) financial /calendar years~~

<i>Year</i>	<i>Name of the Works</i>	<i>Name of the Employers</i>	<i>Quantity of Concrete (M35 or richer mix) (Cum)</i>	<i>Remarks</i>
<i>1</i>	<i>2</i>	<i>3</i>	<i>4</i>	<i>5</i>

PROFORMA VIII

The tenderer to qualify this bid shall own or have assured access (through hire, lease, and other commercial means) in full working order, to the equipments as listed below, and must demonstrate that based on known commitments, they will be available for timely use in the proposed contract.

<i>Sr.No</i>	<i>Equipment</i>	<i>No</i>
<i>1</i>	<i>2</i>	<i>3</i>
1	Computerized Batch mix Asphalt Plant Capacity min. 80 M.T per hr. with valid registration of M.C.G.M.	
2	R.M.C Plant (computerized) – Capacity 60 Cu.m per hr. (or two nos. of 30 Cu.m. per hr. in lieu of 60 cum per hr.) with valid registration of M.C.G.M.	
3	Paver Blocks (BIS Certified) manufacturing factory approved by M.C.G.M with valid registration.	

NOTE: a) The minimum suggested major equipments to begin with for execution of works in accordance with the prescribed construction schedule are shown in the above list. The contractor shall mobilize prior to bidding of this bid and mandatorily during the contract implementation, additional equipment as directed by Engineer-in-charge.

PROFORMA IX

Information on Litigation History in which the tenderer is involved.

<i>Other Party (ies)</i>	<i>Employer</i>	<i>Cause of Dispute</i>	<i>Amount involved</i>	<i>Remarks showing Present Status.</i>
<i>1</i>	<i>2</i>	<i>3</i>	<i>4</i>	<i>5</i>

Note: Scanned Attested copies of completion/performance certificates from the Engineer-in-charge for each work should be annexed and uploaded.

PROFORMA – X

Information of certificate issuing authorities

<i>Sr.No.</i>	<i>Employer/Name of issuing Authority</i>	<i>Designation of issuing Authority</i>	<i>E-mail ID of issuing Authority</i>	<i>Contact numbers of issuing Authority</i>
---------------	---	---	---------------------------------------	---

PROFORMA –XI: FOR ROAD WORKS.

INFORMATION ABOUT INSTALLATION OF SCADA ETC.

MANDATORY REQUIREMENT FOR REGISTERED/ASSURED PLANTS REQUIRED AND TO ALL MACHINERIES OWNED/ASSURED REQUIRED.

MANDATORY REQUIREMENT:

<i>Particulars</i>	<i>Whether Installed</i>	<i>Copies of Certification of installer company enclosed.</i>
	<i>Yes / No</i>	<i>Yes/ No</i>
<i>1</i>	<i>2</i>	<i>3</i>
Intelligent Compaction system - compatible for L&T, Escort, JCB, Greaves or equivalent make Compactors.		
Agent Software for Compactor		
Batch Mix Plant SCADA Automation		
Software Agent Batch Mix Plant connectivity		
Software agent RMC plant connectivity		
Vehicles Tracking System with automation loading unloading Switch		
Vehicles Tracking System Per month Subscription charges		
SCADA Automation for ICPB Factory		

Note:- Intending tenderer shall give undertaking to provide the information on SCADA as required in PROFORMA – X.

SECTION 15

SPECIAL CONDITIONS OF TENDER AND SPECIAL DIRECTIONS TO THE BIDDERS

SPECIAL CONDITIONS OF THE TENDER

1. Refer circular no. Dy.Ch.Eng./SWM/3957/OD dt. 28.09.2018 for implementation of the Construction and Demolition Waste Management Rules,2016.
2. The surplus excavated material shall be disposed of by contractor from the premises completely as per debris management plan to be obtained by the contractor from AE (Env.) of concern ward and no claim for payment will be entertained on accounts of lead, lift, transportation etc what so ever. Also, payment to appropriate authority will be the responsibility of the contractor.
3. The contractor should provide barricading for protection of work site at his own cost to the work site in conformity with the circular U/No.MGC/F/6342 dtd 05.05.2018 as directed by Engineer for which no payment will be made.
4. The Bidder should submit indemnity bond on stamp paper of Rs.500/- indemnifying M.C.G.M.and its officers against any mishaps, casualties and loss of human life during the progress of work as well as during the defect liability period.
5. Contractor must quote the rate with respective of detailed study & scrutiny of BOQ items & quantities. Contractor will not be considered for any kind of additional payment in the latest stage of project for any missing items or extra items or excess items which are necessary for satisfactory completion of work.
6. All the requisite permissions/statutory permissions from state Govt., Central govt., Collector, Electrical supply authorities, Environmental, Local surroundings, Ward office etc. required to commence, execute, commissioned and hand over the project under reference smoothly, shall be obtained by bidder. Bidder shall note the same & quote accordingly. Nothing extra will be paid to contractor for above purpose. Only letters will be issued from M.C.G.M. to various authorities/departments for obtaining various permissions required to execute the work under reference smoothly and in time.
7. In case of any discrepancy in various conditions specifications in the bid document and GCC stringent conditions/stipulations shall apply.
8. The EMD of the Bidders will be forfeited if bidders submit misleading information and non- workable rate analysis.
9. For uneven size of chamber and chamber prone to heavy traffic, contractor should submit the chamber cover design through structural consultant on MCGM panel on approval of design by E.E.W.W.(Civil)Maint / A.E.W.W.(Civil)Maint, work to be executed.

SPECIAL DIRECTIONS TO THE BIDDER

1. Tenderers are requested to visit the site and verify the site conditions, nature and quantum of work before submitting the tenders.
2. The tender may be considered incomplete, irregular and invalid unless
 - i) It is signed by the proprietor, named managing partner or all partners or by the party or parties stating specifically their position and status at the following three

places;

- a) The printed undertaking addressed to the Municipal Commissioner is given.
- b) The schedule of quantities and rates and specifications.
- c) The authority letter from the manufacturer / agent / traders submitted by the tenderer.

ii) The names and address of all the partners are given in the space provided therefore.

iii) As certified copy of Sales Tax registration certificate is produced along with the tender.

3. The amount quoted shall include for provision of all necessary labour, plant, equipment, scaffolding and centering, propping wherever required etc.

4. The rates quoted shall be firm and no variation will be allowed on any account.

5. It is mandatory for the contractors to open a Bank Account in any of the banks approved by MCGM for easy and quick payments. All payments under the contract will be made only on this Bank Account through Electronic Clearing System/ RTGS/ NEFT/ CBS

6. Insurance: Before commencing execution of work, contractor should ensure at his cost against any damage, loss or injury that may occur to any property including any of their personal and employee of Municipal Corporation arising out of contract. All insurances to be effected by the successful tenderer shall be taken up with the Director of Insurance, Maharashtra State only.

7. Security Deposit: Successful Tenderer shall have to pay a security deposit as per G.C.C. w.e.f. 27.09.2016 as amended up to date.

8. Addition / alteration :

Any addition / alteration / omission required for any work shall be carried out only after obtaining prior approval of the Engineer in writing.

9. The tenderer / contractor will have to make good, without any extra payment any damage or loss to the Municipal property while executing the work.

10. Maximum care should be taken to the satisfaction of the Engineer to provide and maintain adequate protection to all electrical and mechanical installations. No extra payment will be made on this account under any circumstances.

11. Contractor will have to make their own arrangement for getting the electric supply on site for fabrication and allied works at their own cost.

12. The contractor shall intimate the concerned authorities before starting the work and execute the work priority fixed by the Engineer-in-charge. The inventory of serviceable and unserviceable material must be taken jointly with Site-in-charge (Sub-Engineer) before starting of work.

13. Wherever necessary as directed by Engineer-in-charge, the unserviceable materials will have to be removed from the site within the time period as directed. The serviceable material should be handed over to concerned Assistant Commissioner of the Ward.

14. The Corporation will not be responsible for any delay that may be caused due to unforeseen circumstances and no compensation on this account will be paid.

15. Materials brought on the site or debris will not be allowed to be stacked on road & footpath.

16. After completion of the waterproofing work, the leakage test shall be carried out after impounding the water and plugging the openings at least for ten days, without any extra cost.

17. Plumbing and sanitary works will have to be carried out through licensed plumber. All plumbing lines will be provided 2" away from wall with spaces as directed. The horizontal and vertical lines should be in line & level.
18. Notwithstanding the source, the sand shall be washed using electrically operated sand washing machine, before use.
19. The contractor shall take photographs of the work site before commencing, during execution and after completion of work, as directed.
20. The contractor shall take photographs with date & time of all hidden items of the work, before commencing, during execution and after completion of work & maintain the photographic record of all the items executed to justify execution of the work at the risk & cost of the contractor. The register should be duly signed by site-in-charge and Tenderer(s) fortnightly. Failure to abide this condition of Rs. 1000/- per photograph copy will be recovered from the contractor's bill
21. After completion of the proposed work, the tenderer/ contractor will have to hand over the site in neat and clean condition for which no extra payment will be made.
22. The contractor have to provide for site office as per requirement either on his/ her owned place or rented/ leased place. Cost for this may be charged to MCGM by incorporating in the offer. No separate payment may be made for providing the chowky and ancillary items. No permission and space for site chowky will be given / provided on Municipal road/ footpath. The contractor have to make their own arrangement on hire/ lease for site office. A penalty of Rs.1000/- per day will be imposed for Chowky with above facilities, if not provided on site.
23. The noise level shall be maintained within the permissible limit in Silence Zone area during the construction activities by the Contractors as per the notification dated 14-02-2000 issued by the Ministry of Environment and Forests. Municipal Corporation of Greater Mumbai do not have site available for disposal of Debris / Demolition material / excavated earth. The Contractor shall dispose these materials properly at his own risk & cost as directed by MCGM. The contractor shall quote the tender keeping these in mind. No separate payment shall be made for disposal of these Debris / Demolition material / excavated earth.
The bidder shall note that M.C.G.M may appoint consultant for quality audit during execution period. The successful bidder will extend full cooperation and all the necessary help in carrying out any survey; test etc. as directed and adverse decision thereof including rectification
24. If due to small quantity of concrete (Less than 10 Cu.m.) or if concrete is not to be used as structural concrete nominal mix of equivalent strength may be made on site by the permission of Engineer, not below the Executive Engineer. However, rebate of Rs. 100/- per Cu. M. shall be taken for non-using the mix design.
25. The site shall be cleared by removing all surplus material/silt/earth/debris on or before 31st May of every year
26. The contractors shall display the boards giving information of name of the work, date of starting completion, Name of the department and contact telephone numbers. Non-compliance of this condition, a penalty of Rs. 1000/- per day per site shall be imposed on contractor.
27. Successful Bidder has to carry out pull out test of anchor for at least 1% or more of total quantity as per the instructions of Engineer-In Charge for Fair item no. 3 at his

own cost.

28. PENALTY CLAUSES

a. The Engineer not below the rank of Assistant Engineer is entitled to impose a penalty of Rs.2500/- per day for each defective work/lapse, disobedience of orders of the officer not below the rank of Site Engineer. Penalty amount will be recovered from contractors running bill.

This penalty is over and above Penalty mentioned under G.C.C. clause No. 100

b. If it is observed that, the Tenderer(s) carrying out the work fails to comply with the instructions given by the authorities at the A.M.C./M.C.'s level during execution of work twice, the work will be terminated and will be carried out at the risk and cost of the Tenderer(s) and penal action will be taken against them. This decision will not be arbitral at all.

c. The stacked surplus excavated materials shall be removed immediately, failing which a penalty of Rs.5000/- per day per spot will be imposed.

d. Tenderer(s) are requested to take cognizance of the child labour act and to take precaution not to deploy child labourers on the work. If child labourers are found deployed on the work, a penalty of Rs. 5,000/- on the spot will be imposed on the defaulting contractor and further action as deemed fit will be taken.

e. If the site office with the necessary requirements is not provided within 15 days from the receipt of work order, penalty of Rs.2000/- per day will be imposed.

f. The contractors shall provide proper safety gears to their staff, labours. Failure to provide safety gears as per above clause a penalty of Rs.1000/- per labour per day shall be imposed. The contractor will be fully responsible towards the safety of staff and labour for the entire Contract period.

g. Any recommendation / alteration in the work as per decision of Competent Authority of M.C.G.M. shall have to be executed under the same tender conditions.

h. If concrete surface Finish of work is not as per specified class of finish (i.e F1, F2, etc.) and honeycombing is observed in the surface, penalty of Rs. 5000/- per Sq.m. will be imposed.

i. The Tenderer(s) shall implement anti-malarial measures for each site during execution of works in case of failure to implement above measures a penalty of Rs.5000/- per day per personnel shall be imposed.

29. The contractors will have to obtain permission from the traffic police department well in advance either for closing down the road stretch or for diversion of traffic for execution of the work by displaying appropriate boards. The work may be required to be executed in phases as per traffic police permission. The contractors should therefore take this factor into account while quoting.

30. The tenderer(s) should note that the work shall be carried out preferably during day time i.e. from 09.00 am to 06.00 pm only If required to be executed during night hours, holidays & weekly offs, the specific sanction of the competent authority to be obtained.

31. Even though the Tenderer(s) takes all the precautionary measures and by chance any workman is injured or dies due to negligence or otherwise, the Tenderer(s) will be responsible for the claims of damages by the workman or his legal heirs.

32. The Tenderer(s) has to check health of all the labourers employed by him at every fortnight and take precautionary measures and treatment as per the advice of

Medical Officer. If record is not maintained by the Contractor, penalty of Rs. 1000/- per labour will be imposed.

33. Web Connectivity: The Tenderer(s) shall provide web connectivity to all above monitoring system. Web connectivity shall have minimum 1 MBPS Internet speed & 100% availability. Software should be intelligent. In case of connectivity failure it should maintain the pending files and send them as soon as it is connected. The Tenderer(s) shall make sure that the entire software and hardware solution is virus free.

34. Quantities of all items provided in the B.O.Q. may not be required to be executed depending upon site conditions. M.C.G.M. reserves right to make any changes in scope of work / reduction of part or whole work. The tenderer shall not be entitled to claim any damages/compensation etc. for less quantity executed or cancellation of whole work or part thereof.

35. All the necessary precautions, safety measures etc. for the contractors staff at the work site shall be the responsibility of the successful tenderer(s). The successful tenderer(s) shall also be liable for any injury to the life & damage to private, municipal or government properties if any caused by them during the operations connected with this work. In this if any legal issues arise in any term the contractors will be solely responsible for such kind of legal issues/disputes and M.C.G.M. will not be a party in this matter.

36. Work Records: - All specified up to date site record should be maintained by the contractors. If the Tenderer(s) fails to comply with this condition, the penalty of Rs.1000/- per day per record will be imposed on the contractors.

37.

List of Registers	
Sr. No.	Name of Register
1	Inventory Register
2	Correspondence file
3	External & internal utility remarks file
4	File containing drawings
5	Daily Progress Register
6	Instruction Register
7	Level Book
8	Mix design file
9	Materials Testing Result file
10	Photograph file
11	Excavation Register (Asphalt , rock, soil etc)
12	Filling/Embankment Register
13	Granular Sub-base / K.T.R.Register
14	Wet mix Macadam ./Water Bound Macadam .Register
15	Sand Metal Filling Register
16	Misc work register
17	M 15 CC Register
18	M 20 CC Register

19	M 40 CC Register
20	M15,M20, M35/M40 Cube & Beam registers
21	Ready Mix Concrete Challan file
22	Cement Variation Register
23	Cement Register
24	Asphalt macadam (mixes) register
25	Dense Bituminous Macadam Register
26	Asphalt concrete /Seal coat Register
27	Asphalt challan file
28	Penalty Register.
29	Steel register
30	Visual/ video recordings in form of CD's
31	Form work shuttering register
32	Precast register
33	Any other register as per directions of Engineer in Charge.
NOTE	From above list the registers applicable for the specified work shall be maintained

The bidder shall note that M.C.G.M may appoint consultant for quality audit during execution period. The successful bidder will extend full cooperation and all the necessary help in carrying out any survey; test etc. as directed and adverse decision thereof including rectification.

SECTION –16
G. S. T.
(Goods and Service Tax)

GST CONDITION

“Chapter XXI- Miscellaneous, section 171(1) of GST Act, 2017 governs the ‘Anti Profiteering Measure’ (APM).

As per the provision of this section, ‘Any reduction in rate of tax on any supply of goods or services or the benefit of input tax credit shall be passed on to the recipient by way of commensurate reduction in prices’

Accordingly, the contractor should pass on the complete benefit accruing to him on account of reduced tax rate or additional input tax credit, to MCGM.

Further, all the provisions of GST Act will be applicable to the tender.”
G.S.T. and other state levies/cess which are not subsumed under GST will be applicable. The tenderer shall quote inclusive of all taxes. It is clearly understood that MCGM will not bear any additional liability towards payment of any Taxes and Duties. Wherever the services to be provided by the tenderers falls under Reverse Charge Mechanism, the price quoted shall be exclusive of GST, but inclusive of Taxes/Duties/Cess other than GST, if any.

Rates accepted by MCGM shall hold good till completion of work and no additional individual claim shall be admissible on account of fluctuations in market rates; increase in taxes / any other levies / tolls etc. except that payment / recovery for overall market situation shall be made as per price Variation.

Irrevocable Undertaking

(on Rs.500/-Stamp Paper)

I Shri/Smt..... aged, years Indian Inhabitant.
Proprietor/partner/Director of M/s resident at
..... do hereby give Irrevocable undertaking as under;

1) I say & undertake that as specified in section 171 of CGST Act, 2017, any reduction in rate of tax on supply of goods or services or the benefit of input tax credit shall be mandatorily passed on to MCGM by way of commensurate reduction in prices.

2) I further say and undertake that I understand that in case the same is not passed on and is discovered at any later stage, MCGM shall be at liberty to initiate legal action against me for its recovery including, but not limited to, an appeal to the Screening Committee of the GST Counsel.

3) I say that above said irrevocable undertaking is binding upon me/my partner/company/other Directors of the company and also upon my /our legal heirs, assignee, Executor, administrator etc.

4) If I fail to compliance with the provisions of the GST Act, I shall be liable for penalty/punishment or both as per provisions of GST Act.

Whatever has been stated here in above is true & correct to my / our own knowledge & belief.

Solemnly affirmed at

DEPONANT

This day of

BEFORE ME

Interpreted Explained and Identified by me.

MUNICIPAL CORPORATION OF GREATER MUMBAI

CIRCULAR

U/No.MGC/F/6342 dated 5.5.2018

Sub.: Revised guidelines regarding barricades being used during the execution of various infrastructure development projects by MCGM in Mumbai.

Various infrastructure development projects are being executed by MCGM for the betterment of citizens of Mumbai. During the course of execution of the projects, it is necessary to provide strong and secured barricading as a safety measure to avoid any mishaps as well as to avoid nuisance to vehicular and pedestrian traffic. Nowadays, the following types of barricades are being used exclusively in MCGM as per the convenience of various departments at different sites.

1. Water/sand fillable PVC Metro barricades.
2. RW 7.45 (G.I. sheets of 22 gauge fixed on 3 inch dia. Wooden bullies buried in existing road sufficiently)
3. RW 7.36 (G.I. sheets of 22 gauge fixed on MS Angle post buried in half the depth in drums of 20 litres capacity in 1:3:6 concrete)
4. Structural steel barricade for major trenches having depth more than 2.00 meters.

Thus from the above, it can be seen that there is no uniformity in provision of barricades as they are of different size and shape. Further it is also observed that the continuity is not maintained in providing the barricading keeping gaps in between thus endangering the safety of vehicular as well as pedestrian traffic. Also the barricades are not being cleaned, thus further adding to shabbiness. Further Mumbai being the financial capital of India, people from all over the world visit the city daily and to maintain good image of city the following decisions are taken.

- A) Only two type of barricades having department wise colour coding are proposed to be used depending upon the nature of work i.e. Minor and Major.
- i) **Minor works:** Barricading made out of 1.5 mm thick MS plate fixed on M.S. angle post/ frame of 65 mm X 65 mm X 6 mm having height of 1.5 m supported on as shown in Annex-I.
 - ii) **Major works:** Structural steel barricade made out of 1.50 mm thick M.S. Plate ISMB 250, ISLC 250X50mm and ISA 50mmX50mmX6 mm having of size 2.5 m X 2 m as shown in Annex-II.
- B) The department wise colour coding for the barricading shall be as under:-
- i) H.E. & W.S.P. department – **Blue**
 - ii) Roads, Traffic, Bridges and Coastal Roads department– **Yellow**
 - iii) S.P. & S.O department – **Green**
 - iv) S.W.D., Building Maintenance department & for ward works – **Red**
- C) The basic principle behind installing secured and continuous barricading is to ensure the safety of vehicular as well as pedestrian traffic and residents in the nearby vicinity of the project. Due to non-installation of appropriate barricades on sites if any mishap occurs leading to injury or loss of life, then the contractor and contractor's Engineer in-charge will be liable for the consequent action.
- D) During the course of execution of project, if it is noticed that the contractor has not provided barricading then a penalty of Rs.1000/- per meter per day will be imposed upon the contractor and will be deducted from the due Bill. This penalty shall be a part of penalty as per tender condition.
- E) Details of the work shall be prominently displayed on the central panel of the barricades along-with the Social Slogans as given in Annexure III and the Cycle of the same shall be maintained.
- F) The contractor shall provide and install the barricading alongwith the slogans printed as per the Annexure III, at his own cost and no payment will be made for this, however the contractor shall quote the bid accordingly by considering the cost of barricading.

The condition shall be included in the tender as given below. “
Barricading shall be provided free of cost as per Circular vide U/No.MGC/F/6342 dated 5.5.2018 and as per Annexure I, II and III of Standard drawings and specifications with slogans and department wise colour codes.” The copy of circular will be attached to the tender as a part of tender document.

This circular will be applicable for the new tenders proposed to be invited from 01.05.2018 and also the corrigendum shall be attached to tenders which are uploaded. However, for the projects wherein the tenders are already invited, the barricading shall be provided strictly as per tender condition. All the details (Annexure I, II & III of Standard drawings and specifications with slogans and department wise colour codes, sketches and department wise colour coding) are uploaded on MCGM portal.

This circular shall come in force with immediate effect.

sd/- 20.4.2018
(Shri V.P . Chithore)
Dir.(ES&P)

sd/- 20.4.2018
(Shri R. B. Bambale)
D.M.C.(S.E.)

sd/- 21.4.2018
(Shri Vijay Singhal)
A.M.C.(E.S.)

sd/- 21.4.2018
(Dr. Shri Sanjay Mukherjee)
A.M.C.(P.)

sd/- 5.5.2018
(Shri Ajoy Mehta)
M. C.

sd/-16.5.2018
(Shri P. R. Kadam)
D.M.C.(S.E.)

ANNEXURE II

B) Major works:

Providing, fabricating and installing the structural steel barricading made out of 1.5 mm thick M.S. plate of size 2500 mm X 2000 mm, ISMC 250 X 50 channels, M.S. Angles ISA 50 X 50 X 6mm and ISMB 250 as per IS 1161-1 RHS/SHS rolled angle plates of TATA Steel, Lloyd Steel, SAIL, ESSAR steel approved in straight profile of all sizes, shapes and for all works including stiffeners, bolts and nuts, file / butt welding, splicing, machine grinding, of all member joints wherever required to give neat appearance, and daily cleaning the barricading along with displaying of the Depthwise slogans as given in Annexure -III etc with interlocking arrangement to avoid gap in between and as directed by Engineer in-charge.

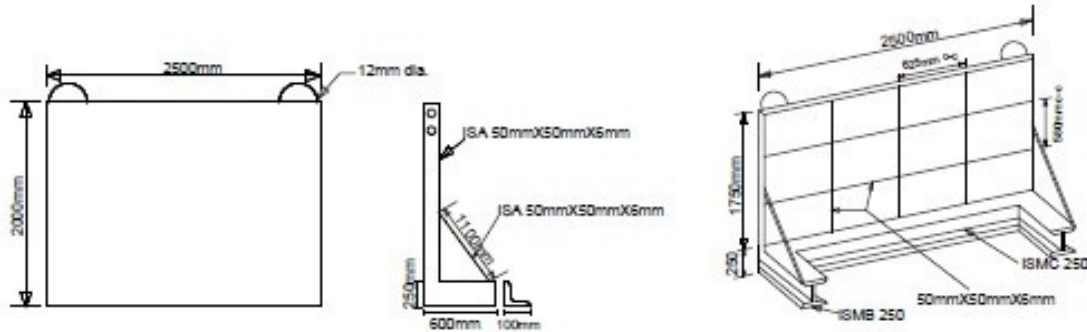

ANNEXURE III

1) HYDRAULIC ENGINEER'S DEPARTMENT/ WATER SUPPLY PROJECTS

- i) Inconvenience regretted
- ii) Ensuring Mumbai's water supply
- iii) Save water Save life

2) ROAD, TRAFFIC / BRIDGES DEPARTMENT

- i) Inconvenience regretted
- ii) Working towards a better tomorrow
- iii) My Mumbai, Green Mumbai

3) SEWERAGE PROJECTS DEPARTMENT/ SEWERAGE OPERATIONS DEPARTMENT

- i) Inconvenience regretted
- ii) Reduce Reuse Recycle
- iii) Clean Mumbai , healthy Mumbai

4) STORM WATER DRAIN DEPARTMENT/ WARD WORKS

- i) Inconvenience regretted
- ii) Working towards a better tomorrow
- iii) Swatch Bharat

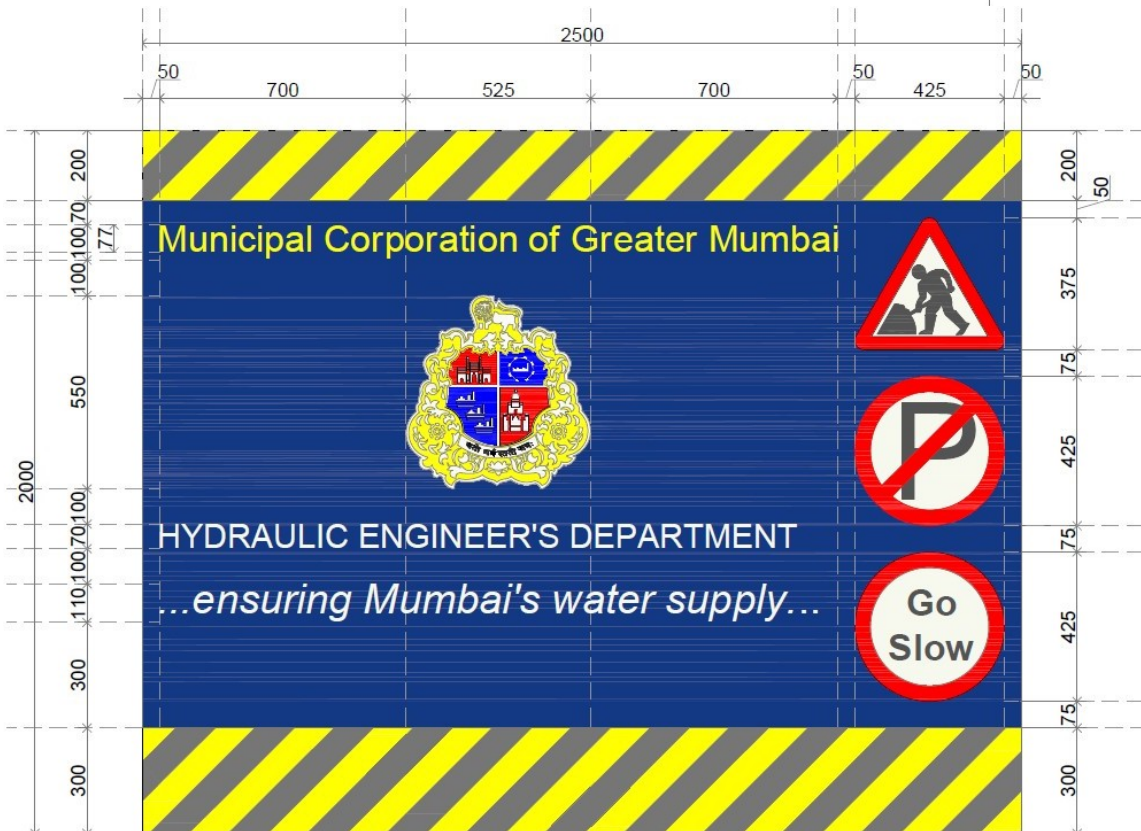
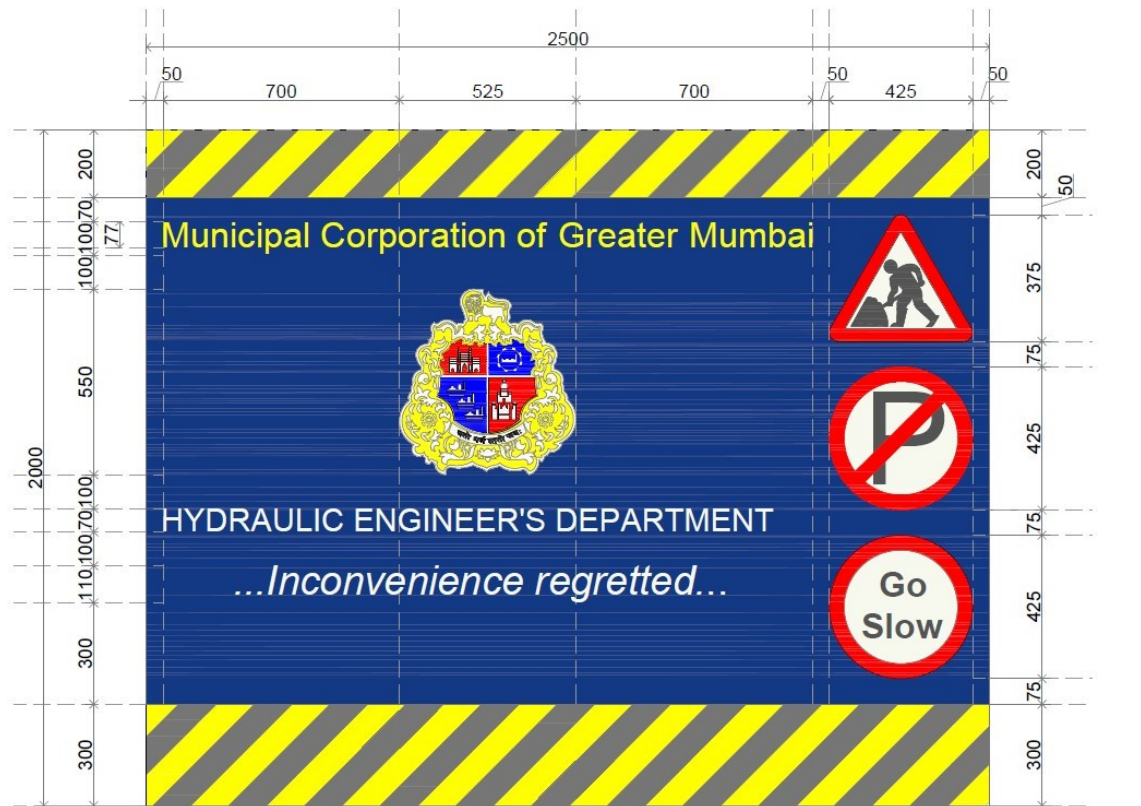

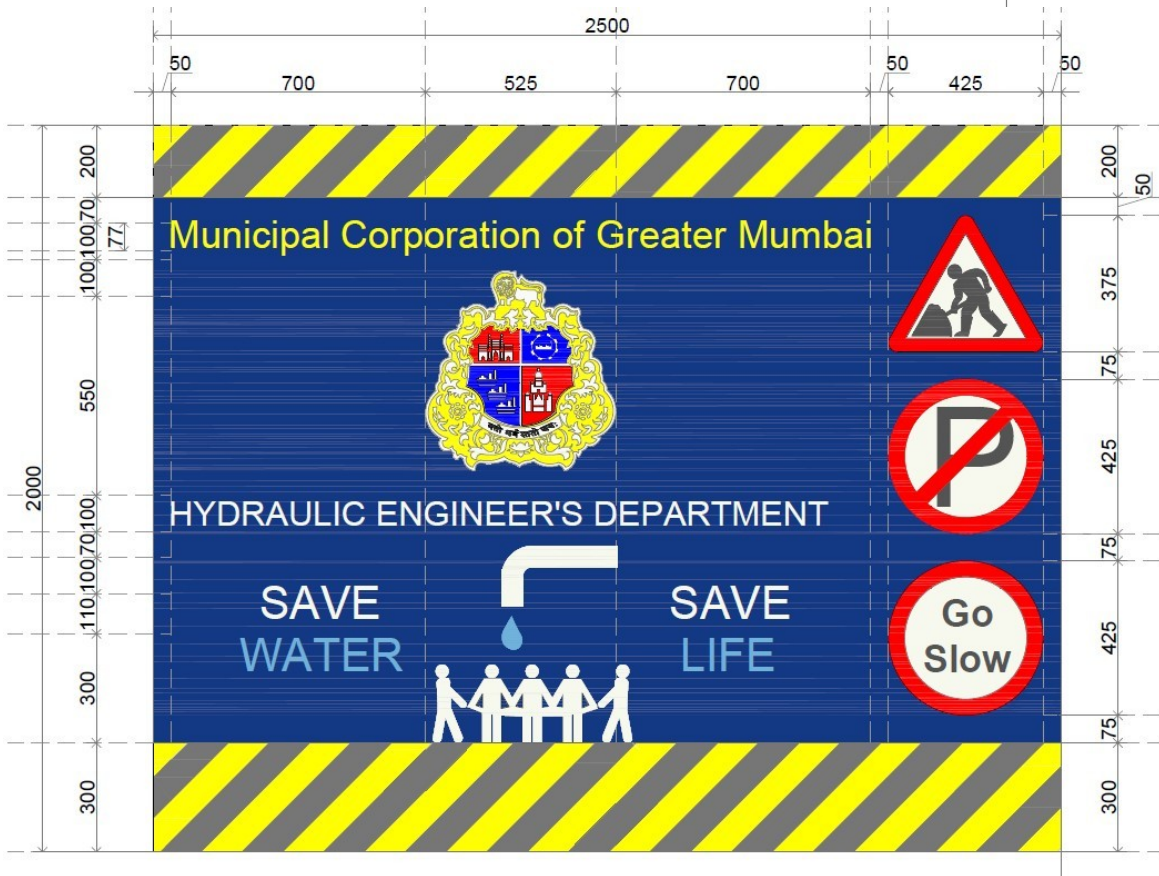
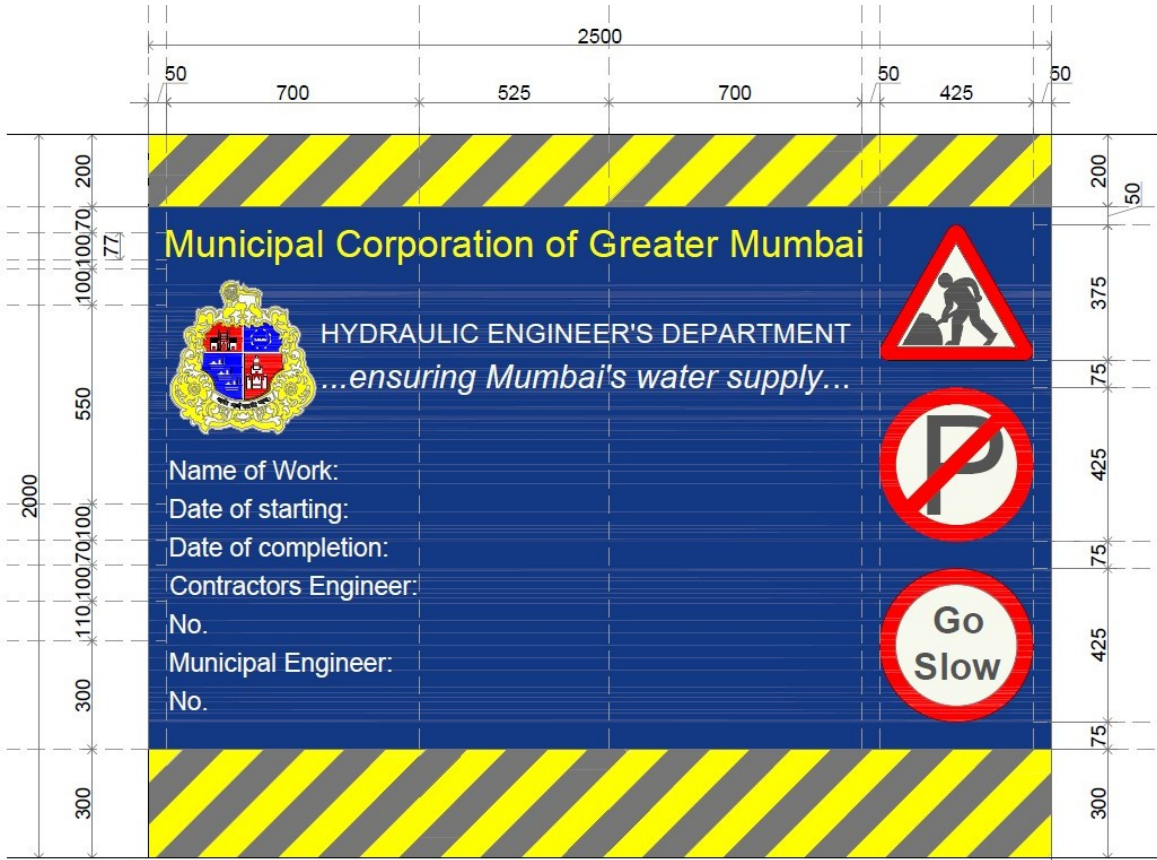

MUNICIPAL CORPORATION OF GREATER MUMBAI

No. DIR/ES & P/1078/mc dtd. 30/11/2018

Sub : Govt. directives issued u/No.

- 1) सार्वजनिक बांधकाम विभाग, शासन निर्णय क्र. सीएटी-1096/प्र.क्र.172/इमारती-2, दि. 20-4-1998.
- 2) सार्वजनिक बांधकाम विभाग, शासन निर्णय क्र. सीएटी-2017/प्र.क्र.8/इमारती-2, दि. 12-4-2017 व दि. 29-6-2017 चे शुध्दीपत्रक.
- 3) सार्वजनिक बांधकाम विभाग, शासन निर्णय क्र. सीएटी-1096/प्र.क्र.172/इमारती-2, दि. 16-8-2017.
- 4) शासन शुध्दीपत्रक क्रमांक: सीएटी-1096/प्र.क्र.172/इमा-2 (संकीर्ण-2017/प्र. क्र.94/इमारती-2) दि. 21-9-2017.
- 5) शासन निर्णय क्रमांक: सीएटी-2017/प्र.क्र.08/इमा-2 दि. 27-9-2018.

Ref : Hon`ble M.C.'s order under no.MGC/F/7640 dtd. 05-11-2018.

Reference is requested to the above Govt. directives wherein it is clarified that the P.W.D. has now stopped registration of contractors from 21-8-2017 for more than Rs. 1.5 crore works and now there is only one category for registration i.e. upto Rs. 1.5 crore.

The proposal was submitted for Hon`ble M.C.'s approval to accept the work experience of Semi-Govt./Govt. works and registration condition with P.W.D. shall not be insisted hereafter for the works more than Rs. 1.5 crores as the registration for more than Rs. 1.5 crore work is stopped by P.W.D. The same is approved by Hon`ble M.C. vide No. MGC/F/7640 dtd. 05-11-2018.

All the concerned are hereby directed to note the above approval and act accordingly while scrutinizing the tenders.

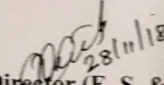

28/11/18
Director (E. S. & P.)

City Engineer/Ch.Eng.(Roads & Traffic) / Ch.Eng. (Bridges) / H. E. / Ch.Eng. (WSP)
/Ch.Eng.(S.P.) / Ch.Eng.(MSDP) / Ch.Eng. (BM) / Ch.Eng.(Vig) / Ch.Eng. (M&E) /
Ch.Eng.(D.P.)/Ch.Eng.(SWD) / Ch.Eng.(SWM) / Ch.Eng.(CTIRC)/ Ch.Eng. (Coastal
Roads) / Dv. Ch.Eng.(HIC) / Dv.Ch.Eng.(SIC)/ Supt. of Gardens
Asstt. Comm. 'A' to 'J' Ward

No. DIR/ES & P/1078/mc dtd. 30/11/2018

C.C. to : DMC(MCO)/ DMC(GA)/ DMC(Vig)/ DMC(SE) / DMC(E)/ DMC(CPD)/
DMC(SWM)/ DMC(Z-I) / DMC(Z-II) / DMC(Z-III) / DMC(Z-IV) / DMC(Z-V)/
D.M.C. (P.H.) / DMC(Z-VI)/ DMC(Z-VII) / C.A. (F) / C.A. (WSSD)

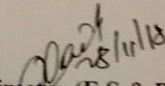
Forwarded for information please.

28/11/18
Director (E.S. & P.)

Municipal Corporation of Greater Mumbai

No. Dy.Ch.Eng./SWM/3957/Qd. dt. 10/9/2018
28-9-2018

CIRCULAR

Subject: Implementation of the Construction and Demolition Waste Management Rules, 2016

Reference: i) Hon'ble Supreme Court's order in the Special Leave Petition (civil) No. D 23708/2017, dated 15/03/2018
ii) Hon'ble M.C. Sir's Approval u/no. MGC/F/7076 dtd. 30.08.2018

The Construction and Demolition Waste Management Rules, 2016 is applicable to 'every waste resulting from construction, re-modelling, repair and demolition of any civil structure of individual or organisation or authority who generates construction and demolition waste such as building materials, debris, rubble'.

Hon'ble Supreme Court vide order dated 15/03/2018, has directed to dispose of construction and demolition waste material by following due-procedure in accordance with the provisions of the Construction and Demolition Waste Management Rules, 2016".

In order to put curb on the un-authorisedly dumped waste, it is essential to control it by asking ward Maintenance department or any MCGM department to issue work-permission only after assessing the total estimated quantity of C&D waste likely to be generated out of the repairs / construction / trenching work or any such civil works, and asking them to make payment in advance or in stages of waste generation for the 'Debris on Call' system or transport C&D waste to designated unloading site.

Following standard operating procedure is proposed to be adopted:

- 1) MCGM department like A. E. (Maintenance), A. E. (B&F), H.E., S.O., S.P., M.S.D.P., W.S.P., S.W.D., S.W.M., C.E., B.C., B.M., Roads, Bridges, etc. carrying out civil work / repairs works etc. shall put condition in the tender / quotation / work order to dispose of C&D waste generated either by (i) 'Debris on Call' scheme if generation of C&D waste is less than 300MT for entire project or (ii) contractor shall transport to designated unloading site approved by MCGM S.W.M. department by following due procedure if C&D waste is more than 300MT for entire project.
- 2) The estimated quantity of the C&D waste generated shall be certified by A.E. (Maintenance) Ward or the concerned department.
- 3) If quantity of C&D waste is less than 300MT, A. E. (S.W.M.) Ward will issue Challan for making payment as per 'Debris on call' scheme on approval from Zonal Ex. Eng. (S.W.M.).
- 4) If quantity of C&D waste is more than 300MT, the contractor / agency will submit C&D waste management plan complete with requisite documents to Zonal Ex. Eng. (S.W.M.). On approval, the contractor / citizen / agency carrying out the civil works will be allowed to transport the C&D waste material to the designated unloading site.
- 5) The contractor / citizen / agency carrying out the civil works shall maintain & submit the appropriate record like date, quantity of C&D waste transported, vehicle No., Challan of Receipt of C&D waste from unloading site etc.
- 6) The whole system of issuing NOC for C&D waste transportation and payment will be made ONLINE and for this M/S. Softtech will be asked to develop appropriate software on the basis of existing norms being done for auto-DCR portal.
- 7) The proposals will be processed manually till the complete system fully operational online.
- 8) All the contractors / agencies using designated unloading site must maintain proper record of the C&D waste generated and transported along with date and vehicles through which C&D is transported & the copies of Challans from unloading site for having unloaded the C&D waste and submit the same to A.E. (S.W.M.) ward through concerned department.

Sd/-07/08/2018
Ch. Eng. (S.W.M.)

Sd/-07/08/2018
D.M.C. (S.W.M.)

Sd/-10/08/2018
A.M.C.(E.S.)

Sd/-29/08/2018
Municipal Commissioner

Forwarded for information and compliance please

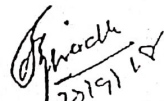
23/9/18
Dy. Ch. Eng. (SWM) Op.

MUNICIPAL CORPORATION OF GREATER MUMBAI
(Hydraulic Engineer's Department)

Sub:- Proposal to make Amendment in Tender Condition of HE department.

- Ref:-**
- 1) DMC/Infra/3732/dt.13.10.2021
 - 2) Ch.E/4300/ SWD. dt.11.11.2021
 - 3) u/n.CA/F/P/41.dt.09.02.2021
 - 4) u/n.CA/F/P/42.dt.09.01.2021
 - 5) u/n.CA/F/P/21.dt.07.09.2021

Reference is requested to Ch.E (Rd & Tr) & DMC(Infra)'s above cited note regarding modifying PQC guidelines circulated to all Ch.E/H.E by introducing of stringent guideline for forthcoming tender invited by the MCGM to curb the tradition of high percentage rebate so that enhance quality of proposed work can be obtained. The recommendation proposed by Ch.E(Rd & Tr) & DMC(Infra) , was put up by AMC(P) to Hon.M.C which was approved u/n. MGC/VIP/9612. Dt.01.10.2021. (Copy attached at pg no. C-01 to C-09). The said approved stringent modified PQC condition was circulated and received to this department with Hon. AMC(P)'s direction. In the said note in para pt no. 6 which is as **“The HOD of different engineering department should be asked to examine the tender proposal and loophole contributing to very high rebate rate. They should be asked to submit proposal within two months to make amends in tender condition and in SBD so that the tender bid are received in the logical and reasonable range (-15 to +10 range). The Dir.(ES & P) may leads this efforts and appropriate amends need to be made in all department”**.

After impact of covide-19 certain relaxation and concession was given to the bidders in respect of payment of ASD, Retention money, insisting BG for balance period of Defect Liability Period(DLP) and not to insist Performance Guarantee. After implementation of said guideline it is observed that the tender invited by HE department for various work has received the trend ranging from rebate of 40 to 29.99%. Hence there is urgent need to review the various concession offered to the prospective bidder as mentioned in the circular ref. no. 3 to 5 above & on the line of Ch.E (Rd & Tr)/ DMC(Infra) note at pg no. C-01 to C-09.

The nature and scope of the work carried out in HE department is enlisted as below:

1. Laying/ Replacement of various dia. water main.
2. To attending leakages, contamination & short supply complaints.
3. Renewal of Service Connections due to Road improvement work to avoid further excavation.
4. To lay stub main for Removal of Bunch of connection in slum area.
5. Reinstatement of trenches carrying out for laying of water main and other work enclosed at sr. No 1 to 4 above.
6. Structural repair/ Construction of structures to maintain safety of the structure.
7. Structural repair to compound wall to maintain safety of the structure.
8. Structure Repair to Road over Bridge/ culvert to maintain safety of the structure.
9. Hill slope stabilisation to maintain safety of the structure.
10. Garden Maintenance to maintenance and surveillance of lakes and garden.
11. Electrification of lake and surveillance to maintenance and surveillance of lakes and garden.
12. Construction of Thrust Block.
13. Structural repair/ Construction of Compound wall to safeguard land from encroachment.
14. Repairs pothole of service road to maintain service road for convenience.
15. Total Station survey.

A joint meeting in the chamber of HE was held on 27.12.2021 along with all Dy.HE's of the department and after thorough discussion regarding amendment required to be introduced in the tender of HE department are summarized with the relevant tender clauses in respect of payment of ASD, Performance Bank Guarantee, Deferred Payment, contract Deposit, Retention Money and procedure for releasing the Deferred Payment in stage wise proportionate with the completion of DLP .The amendment proposed are tabulated at pg no N-03 to N-09 for kind pursual of HE/DMC(SE)/AMC(P)/ Hon.M.C.

Sr. No.	Tender Clause no.	Conditions Before Covid-19	Current Conditions	Proposed modifications and additions for New tenders	Reason for proposed change						
1	6.19(B) - Additional Security Deposit (ASD)	<p>The additional security deposit will be applicable when a rebate of more than of 12 % at the rate of with no maximum limit. The ASD is calculated as follows:</p> <p>Additional security deposit = (X/100) x office estimated cost,</p> <p>Where,</p> <p>X=percentage rebate quoted above 12%</p> <p>The ASD shall be paid online in the ASD tab for bidders in e-tendering system before submission of the bid.</p>	<p>The circular u/no. CAF/P/42/ dtd. 09.02.2021</p> <p>1) If the Lowest bidder quotes rebate more than 12% then the applicable additional security deposit(ASD) at the rate of 1% for each percentage quoted below 12 % will not required to be paid online while submission of tender online.</p> <p>2)Aftersanction/approval of competent authority to the contract cost, the lowest bidder shall deposit ASD in the Municipal Citizen Facility Centres in the form of demand draft as mentioned in letter of Acceptance (LOA) within 15 working days as per prevailing practice and the receipt of the same shall be submitted to Head of Department.</p> <p>3) If the first lowest bidder will not paid ASD within 15 working days after issue of LOA, then the EMD paid by the concern company will be forfeited and the company will be debarred for two years, similarly if the director/partner of the company is also working in other company as a director / partner then said company will also be debarred for two years.</p>	<p>Additional Security Deposit shall be applicable as under:</p> <table border="1"> <thead> <tr> <th>Rebate quoted by contractor</th> <th>ASD Applicable</th> </tr> </thead> <tbody> <tr> <td>Up to 12% Rebate</td> <td>No ASD</td> </tr> <tr> <td>Rebate above 12.00% on estimated cost</td> <td>At 2.00% of Estimated cost for each % rebate & part thereof, in D.D only.</td> </tr> </tbody> </table>	Rebate quoted by contractor	ASD Applicable	Up to 12% Rebate	No ASD	Rebate above 12.00% on estimated cost	At 2.00% of Estimated cost for each % rebate & part thereof, in D.D only.	<p>In the recently invited tender ASD was payable within 15 days after issue of LOA. As per circular u/no. CAF/P/42 / dtd. 09.02.2021 ASD was not payable at the time of bidding, Bidders were quoting all bids without restrictions provided they had funds for paying EMD only.</p> <p>This leads to bidding by speculation rather than by</p>
Rebate quoted by contractor	ASD Applicable										
Up to 12% Rebate	No ASD										
Rebate above 12.00% on estimated cost	At 2.00% of Estimated cost for each % rebate & part thereof, in D.D only.										

					checking actual funds availability and also quoted the rate below 30% . Hence compulsion of ASD should be mandatory at the time of bidding process .
2	6.19-D-(Refund of security Deposit)-III-(Refund of Additional Security Deposit)	<p>Refund of Additional Security Deposit:</p> <p>The additional security deposit shall be released within 30 days of issue of 'Certificate of Completion' with respect to the whole of the Works. In the event the Engineer issues a Taking-over Certificate for a section or part of the Permanent Works, only such proposition thereof as the Engineer determines (having regard to the relative value of such section or part of the Works) shall be considered by the Engineer for payment to the Contractor.</p>	<p>Refund of Additional Security Deposit:</p> <p>One-half (50%) of the additional security deposited (ASD) shall be released after the completion of 50% financial progress of the work and the balance one-half (50%) additional security deposit (ASD) can be released against BG</p>	<p>Refund of Additional Security Deposit:</p> <p>One-half (50%) of the additional security deposited (ASD) shall be released after the completion of 50% financial progress of the work.</p> <p>The balance ASD shall be released within 30 days of issue of 'Certificate of Completion' with respect to the whole of the work. In the event the Engineer issues a Taking-over Certificate for a section or part of the Permanent Works, only such proposition thereof as the Engineer determines (having regard to the relative value of such section or part of the Works) shall be considered by the Engineer for Refund of ASD to the contractor.</p>	

3	6.19(B) - Additional Security Deposit (ASD)	The ASD shall be paid online in the ASD tab for bidders in e-tendering system before submission of the bid	The circular u/no. CAF/P/42/ dtd. 09.02.2021 1) If the Lowest bidder quotes rebate less than 12% then the applicable additional security deposit(ASD) at the rate of 1% for each percentage quoted below 12 % will not required to be paid online while submission of tender online.	The bidders shall submit the ASD as applicable in the form of Demand Draft, which is to be submitted within office hours minimum one day before opening of packet 'C' to respective Head Clerk (Expenditure) of the Engineer in-charge of the HE Division in sealed envelope. If A.S.D. is not applicable then the bidders shall submit sealed envelope mentioning on their letter head 'ASD is not applicable'. If the bidders fails to submit the sealed envelope as mentioned above at least one day before opening of Packet 'C' within office hours then the EMD of the respective bidders will be forfeited and the company with their Directors/ Partners and other companies with the said directors / Partner will be further debarred from any tendering process for the period of at least 2 years.	
4	6.19(A)-II- Retention Money	Retention Money – The contractor shall pay the retention money an amount equal to 5% percent of the Contract Sum which will be recovered from the contractors every bill i.e. interim / running / final bill. The clause of retention money will not be applicable M. & E. Department.	As per Circular u/no. CA/F/ Project/21 dated,07.09.2020There is changes in withholding retention amount which is prior to pandemic period is 5 % which is reduced to 2% for newly invited tender and the form of deduction was partly changed by insisting deduction from running account bill & also allowed to convert into Bank Guarantee (B.G.). After completion of 50 % work, refund of the balanced retention money	Retention Money – The retention money equal to 15.00% of the Contract Sum will be recovered from the contractors every bill i.e. interim / running / final bill. The clause of retention money will not be applicable M. & E. Department.	To ensure effective control and improve the quality of work.

			is allowed after period of 3 year in case of DLP of 5 year.		
5	6.19-D-(Refund of security Deposit)- II-(Refund of Retention Money)	Refund of Retention Money: One-half (50%)of the Retention Money shall be released within 30 days of issue of 'Certificate of Completion' with respect to the whole of the Works. In the event the Engineer issues a Taking-over Certificate for a section or part of the Permanent Works, only such proposition thereof as the Engineer determines (having regard to the relative value of such section or part of the Works) shall be considered by the Engineer for payment to the Contractor. The balance Retention Money shall be released within 30 days after completion of 3 rd year of DLP (in case of 5 years DLP) and after issue of 'Defect Liability Certificate' (in case of 1 or 2 or 3 years DLP) provided that the Engineer is satisfied that there is no demand outstanding against the Contractor. In the event of different Defects Liability	Refund of Retention Money: One-half (50%)of the Retention Money shall be released within 30 days of issue of 'Certificate of Completion' with respect to the whole of the Works. In the event the Engineer issues a Taking-over Certificate for a section or part of the Permanent Works, only such proposition thereof as the Engineer determines (having regard to the relative value of such section or part of the Works) shall be considered by the Engineer for payment to the Contractor. The balance Retention Money shall be released within 30 days after completion of 3 rd year of DLP (in case of 5 years DLP) and after issue of 'Defect Liability Certificate' (in case of 1 or 2 or 3 years DLP) provided that the Engineer is satisfied that there is no demand outstanding against the Contractor. In the event of different Defects Liability Periods have been specified or become applicable to different sections or parts of the Permanent Works, the said money will be released within 30 days	Refund of Retention Money: The Retention Money will be refunded after completion of defect liability period and after issue of "Defect Liability Certificate" (in case of 1 or 3 or 5 years DLP) provided that the Engineer is satisfied that there is no demand outstanding against the Contractor. In the event of different Defects Liability Periods have been specified or become applicable to different sections or parts of the Permanent Works, the said money will be released within 30 days on expiration of such Defects Liability Periods. In the event the Engineer issues a Taking-over Certificate for a section or part of the Permanent Works, only such proposition thereof as the Engineer determines (having regard to the relative value of such section or part of the Works) shall be considered by the Engineer for payment to the Contractor.	By incorporating such a condition, it is felt that the contractor will be more conserved & careful about the quality of the work.

		Periods have been specified or become applicable to different sections or parts of the Permanent Works, the said moneys will be released within 30 days on expiration of the latest of such Defects Liability Periods. Payment of the above mentioned 50% is exclusive of the amounts to be withheld as stated in and that amount shall be paid as per condition stated therein.	on expiration of the latest of such Defects Liability Periods. Payment of the above mentioned 50% is exclusive of the amounts to be withheld as stated in and that amount shall be paid as per condition stated therein.		
6	6.19(A)-I Contract Deposit	Contract Deposit – The successful tender, here after referred to as the contractor shall pay an amount equal to two (2)percent of the contract sum shall be paid within thirty days from the date of issue of letter of acceptance. <u>As per present practice it is accepted in BG.</u>	No changes in tender condition.	Contract Deposit – The successful tender, here after referred to as the contractor shall pay an amount equal to two (2)percent of the contract sum shall be paid within thirty days from the date of issue of letter of acceptance. The said contract deposit shall be paid in the form of Demand Draft (D.D) only.	To ensure effective control and improve the quality of work
7	6.15- (C- PACKET) Note-2			<u>New condition proposed:</u> Rate analysis in prescribed format shall be submitted online to the engineer in-	

				charge within 3 working days from the date of communication on email, failing which EMD will be forfeited, and the bid will be rejected, and next successful/ Responsive bidder will be considered. thereafter, negotiation will be done with the said successive / responsive bidder with respect to his quoted rate.	
8	6.16- (Bid Security or EMD) -9	No rejections and forfeiture shall be done in case of curable defects. For non-curable defects the 10% of EMD shall be forfeited and bid will be liable for rejection.	No changes in tender condition.	In case of curable/ non curable defects due to non-fulfillment of requirement of MCGM as prescribed & in the event, the bidder becomes non-responsive & the 10% EMD will be forfeited and bid will be rejected. This shall be in addition to any forfeiture of proportionate EMD for curable defects as per other relevant clauses of the tender document, if applicable.	
9	6.16- (Bid Security or EMD) -10	In case of non workable rate analysis and misleading information submitted by the bidder, EMD shall be forfeited.	No changes in tender condition.	In case of non workable rate analysis and misleading information submitted by the bidder, EMD shall be forfeited and bid will be rejected.	
10	6.16- (Bid Security or EMD)	Wrong calculation of Bid Capacity (Curable Defect)	Wrong calculation of Bid Capacity (non- curable defect)	Wrong calculation of Bid Capacity (Curable Defect)	Which allows more competition, which

				is beneficial to MCGM.
11	6.16- (Bid Security or EMD) -10- (Curable Defect)- note			<p><u>New condition proposed;</u></p> <p>In packet 'A' as well as packet 'B', 02 nos. of shortfall in curable defects will be allowed & <u>2% EMD will be forfeited for each shortfall thereafter.</u></p>
12	2.1(Technical Capacity)	<p><u>For Regular Routine Work:</u></p> <p>a) Three similar completed works each of value not less than the value equal to <u>20%</u> of estimated cost put to tender i.e. Rs..... each <u>OR</u></p> <p>b) Two similar completed works each of value not less than the value equal to <u>25%</u> of estimated cost put to tender i.e. Rs. each <u>OR</u></p> <p>c) One similar completed work of value equal and or not less than the <u>40%</u> of estimated cost put to tender i.e. Rs.</p>	No changes in tender condition.	<p><u>For Regular Routine Work:</u></p> <p>a) Three similar completed works each of value not less than the value equal to <u>30%</u> of estimated cost put to tender i.e. Rs..... each. <u>OR</u></p> <p>b) Two similar completed works each of value not less than the value equal to <u>35%</u> of estimated cost put to tender i.e. Rs. each <u>OR</u></p> <p>c) One similar completed work of value equal and or not less than the <u>50%</u> of estimated cost put to tender i.e. Rs.</p>

In view of above, HE's recommendation and DMC(SE)/ AMC(P)/Hon.M.C's approval is requested to the modified and additional tender conditions as stated at pg no. N- 03 to N- 09

On receipt of the approval, the said modified and additional conditions will be incorporated in the tender documents of upcoming works.

Submitted please.

(Signature)
23/09/2022
(Shri. S. M. Rasal)
Dy.HE.(Construction) HC

No. Dy. HE (Const) 4190 I.R.
11 JAN 2022

(Signature)
11/1/22
HE

(Shri. S.R. Arte)
HE

जअ/२०२०/एसआर
99/9/2022

Due to the high rebate rates being quoted by bidders, instructions were issued to have a re look at the tender/SDD conditions and amend the same.

(Shri. A.S.Rathore)

DMC(SE)

उप आयुक्त / वि.अ. 3548

(Shri. P. Velarasu)

AMC(P)

16.92.09.22

Certain amendments are now proposed, including increase in A2P (2 times) on quote about 12% rebate, increase in Retention money, etc.

(Shri. I.S. Chahal)
Hon.M.C

Respected Sir,

Discussed.
Imprecise
New conditions

On incorporating the above, it is expected to receive rates/bids that are reasonable and logical.

सी. आर	आयुक्त
01	11 JAN 2022
एमसीएल	A.M.C(P)
डी ओ/	२०२०
वॉच	जअ

Submitted for approval pl.
This week

PIA to give time for discussion of these points.

अजय सु. राठोर
उप आयुक्त
(विशेष अभियांत्रिकी)

उप आयुक्त (विशेष अभियांत्रिकी)
याचि कार्यालय
क्र. उप आ/वि.अ./3548
दिनांक 92/09/2022

AMC/P/8108
Date - 23/02/2022

DMC(SE)

PD

(Signature)
18/01/22
A.M.C.(P)

